



# Squiggles TT

User Manual



Supporting  
Children

**The Squiggles TT has been designed to offer the support your child needs in an upright, standing posture. The stander is modular in design and has been developed for use in school or at home.**

**This manual shows how to quickly, safely and easily use your Squiggles TT functions. The instructions on the safety and maintenance will ensure that you will enjoy this product for a long time.**

# Contents

---

1. Intended Use	p.03
2. Declaration of Conformity	p.04
3. Warnings and Cautions	p.04
4. Terms of Warranty	p.06
5. Product History Record	p.06
6. Product Training Record	p.06
7. Safety Information	p.07
8. Precautions and Contraindications	p.08
9. How to unpack and assemble the standing system	p.09
10. Fitting the Cushions	p.15
11. Clinical Setup	p.18
12. Adjustments for Daily Use	p.24
13. Cleaning & Care Information	p.29
14. Daily Product Inspection	p.30
15. Annual Product Inspection	p.31
16. Reissuing Leckey Products	p.32
17. Product Servicing	p.33
18. Technical Information	p.34

## 1.0 Intended Use

---

### Intended use

The devices are intended to assist children that cannot stand or maintain a standing position independently as part of a supported weight bearing program. In addition, Squiggles TT may be used to train static, active and dynamic trunk control via Targeted Training therapy.

### Indications for use

Squiggles TT is a standing frame that enables targeted training which has been designed

for children with disabilities aged 1–5 for use at home or in the classroom. The maximum user weight is 22kgs (48.4lbs). Suitable for:

- Children with deficits in head/trunk control and delays in achieving functional abilities, especially independent upright sitting with or without hand support.
- Children where early intervention is indicated.

## 2.0 Declaration of Conformity

---

The Squiggles TT is classified as a Class I Medical Device under EU and UK regulations. James Leckey Design Ltd as manufacturer with sole responsibility declares that the Leckey Squiggles TT conforms to the requirements of the 93/42/EEC Guidelines, Medical Device Regulations 2017, UK Medical Devices Regulation 2002 and EN 12182 Technical aids for disabled persons and test methods.

**Notice to the user and/or patient: Any serious incident that has occurred in**

**relation to the device should be reported to the manufacturer and the competent authority of the Member State in which the user and/or patient is established.**

**NOTE:**

**General user advice.**

**Not following these instructions may result in physical injury, damage to the product or damage to the environment!**

## 3.0 Warnings and Cautions

---

**WARNING TOPPLING HAZARD:**

- Never use the product on a sloping surface greater than 5 degrees.
- Always check operation of linear drives, gas struts, and motor drives before use.
- When adjusting the stander angle ensure there is adequate access space on all sides of the product.
- Always lock casters facing outwards before placing the user in the product.

**WARNING FINGER TRAP HAZARD:**

- Ensure that the user or carer does not touch any moving joint or pivot that is not locked.
- While the user is in the product, the carer should strive to keep product adjustments to a minimum.

**WARNING OCCUPANT SECURITY:**

- User transfers in and out of the product must be done with appropriate equipment and personnel.
- When transferring the user into the product, first use the pelvic band to secure the user.
- Ensure that all harnesses, sandal straps and chest pad are securely applied.
- If the user exhibits any form of distress, remove from the product as quickly as is safely possible.

**CAUTION FINGER PINCH HAZARD:**

- While the user is in the product, the carer should strive to keep product adjustments to a minimum.

- Take care when assembling or adjusting the position of the stander components that your fingers do not get pinched when positioning stander components and tightening mountings.
- During product assembly and adjustment, the carer should avoid finger pinching risk of the product's joints or pivots.
- During transfers and adjustments, the carer should avoid the finger pinching risk of over-centre buckles and latches.

**CAUTION DAILY CHECKS:**

- The stander is to be checked daily before use to ensure that all harnesses and stander components are securely attached.
- Always check operation of linear drives, gas struts, and motor drives before use.

**CAUTION TRIP HAZARD WITH POWERED CHASSIS:**

- Before moving a powered stander ensure that battery charging connection is removed.

**CAUTION CLEANING:**

- Clean the stander regularly to prevent the build-up of dirt. Accumulated dirt can prematurely wear the fabric components and encourage corrosion on the stander. Only use non-abrasive household cleaners and moist cloths, do not use running water on the upholstery whilst it is still attached to the seat. See section Cleaning & care information.

**CAUTION CLEANING POWER WASHER/ HOSES:**

- Hoses and power washers are not to be used to clean the product. Stander with the electric lift system are not sealed against running water and may be damaged by water ingress. See section Cleaning & care information.

**CAUTION SERVICING/REPAIR OF ELECTRONIC COMPONENTS:**

- All electronic and electrical components are NOT user-serviceable. Servicing and repairs are only to be carried out by Leckey-authorized personnel.

**CAUTION DISPOSAL:**

- When disposing of the product using a community waste disposal site, the frame and any electrical components should be disposed of separately.

**CAUTION BRINGING INTO USE:**

- Before use, allow 2 hours for the product to acclimatise to room temperature.

## 4.0 Terms of Warranty

---

The warranty applies only when the product is used according to the specified conditions and for the intended purposes, following all manufacturers' recommendations (also see general terms of sales, delivery and payment). A three year warranty is provided on all Leckey manufactured products and components.

**Additional Notes For Australia Only:**

i. For goods distributed by Sunrise Medical Pty Ltd in Australia, our goods come with a guarantee by Sunrise Medical (on behalf of the

manufacturer) that cannot be excluded under Australian Consumer Law.

ii. You are entitled to a replacement or refund for a major failure and for compensation for any foreseeable loss or damage.

iii. You are also entitled to have the goods repaired or replaced if the goods fail to be of acceptable quality and the failure does not amount to a major failure.

iv. The benefits to you given by this warranty are in addition to your other rights and remedies under a law in relation to the goods to which the warranty relates.

## 5.0 Product History Record

---

Your Leckey product is classified as a Class 1 Medical device and as such should only be prescribed, set up or reissued for use by a technically competent person who has been trained in the use of this product.

Leckey recommend that a written record is maintained to provide details of all set-ups, reissue inspections and annual inspections of this product.

## 6.0 Product Training Records (Parents, Teachers & Carers)

---

Your Leckey product is a prescribed Class 1 Medical Device and as such Leckey recommend that parents, teachers and

carers using the equipment should be made aware of the following sections of this user manual by a technically competent person:

### 7.0 Safety Information

### 11.0 Clinical Setup

### 12.0 Adjustments for Daily use

### 13.0 Cleaning and Care

### 14.0 Daily Product Inspection

Leckey recommend that a written record is maintained of all those who have been trained in the correct use of this product.

# 7.0 Safety Information

**7.1** Always read instructions fully before use.

**7.2** Users should not be left unattended at any time whilst using Leckey equipment.

**7.3** Only use Leckey approved components with your product. Never modify the product in any way. Failure to follow instructions may put the user or carer at risk and will invalidate the warranty on the product.

**7.4** If in any doubt to the continued safe use of your product or if any parts should fail, please cease using the product and contact our Customer Care Team or local dealer as soon as possible.

**7.5** Carry out all positional adjustments and ensure that they are securely fastened before you put the user into this product. Some adjustments may require the use of a tool which is provided with each product. Keep all tools out of reach of children.

**7.6** When putting the user into the stander both for positional and safety reasons, always secure the pelvic and chest support harnesses first.

**7.7** When the product is stationary ensure that all castors are locked and facing away from the base as this will improve product stability. This is especially important when the support frame is in a reclined position.

**7.8** When the product is in use please ensure that the angle adjustment foot pedal is locked off and cannot be adjusted accidentally, especially if there are children in the area.

**7.9** When the Squiggles TT is used on the Pivot chassis we do not recommend that users are moved over uneven surfaces when in the equipment. All due care and attention should be taken if transporting the user in and out of the stander.

**7.10** Never leave the product on a sloping surface, greater than 5 degrees. Always remember to lock all the castors.

**7.11** Although the Pivot stander is fitted with castors this is not a mobility device. Always place the user in an upright position before moving the stander. Hold the push handle when moving the stander.

**7.12** The product contains components which could present a choking hazard to small children. Always check

that locking knobs and bolts within the child's reach are tightened and secure at all times.

**7.13** Leckey products comply with fire safety regulations in accordance with EN12182. However the product contains plastic components and therefore should be kept away from all direct sources of heat including naked flames, cigarettes, electric and gas heaters.

**7.14** Do not place hot objects greater than 40°C on the tray.

**7.15** Clean the product regularly. Do not use abrasive cleaners. Carry out maintenance checks on a regular basis to ensure your product is in good working condition.

**7.16** The product is designed for indoor use and when not in use should be stored in a dry place that is not subjected to extremes of temperature. The safe operating temperature range of the product is +5 to +40 deg Celsius.

**7.17** Always check the plastic hand knobs on the push handle are tightened securely before you move the unit.

# 8.0 Precautions and Contraindications

---

## Precautions

- Fixed spinal deformities such as scoliosis or kyphosis
- Severe muscle contractures
- Severe muscular or skeletal asymmetry including hip dislocation
- Progressive and muscle wasting conditions
- High risk or recent history of bone fractures
- High risk of pressure related injury or open sores
- Strong, uncontrolled movement patterns
- Poorly controlled seizure activity
- Children dependent on the use of percutaneous endoscopic gastrostomy
- Medical instability including compromised respiratory or cardiovascular function
- Dependant on 3rd party life-sustaining apparatus such as oxygen tanks
- Significant learning disabilities and/or behavioural issues

## Contraindications

- Children experiencing pain or discomfort that cannot be resolved by adjustment of support/positioning
- Children with hip/ knee flexion contracture beyond the limits of the stander

All precautions and contraindications are taken at the discretion of the prescribing clinician or parent. Leckey recommends a trained and experienced clinician to be present during all initial assessment, set ups, configurations, and reissues to minimise risk.

# 9.0 How to unpack & assemble the standing frame

## 9.1 Folding and unfolding the pivot chassis

The Pivot Chassis can be easily folded for storage or transportation. To unfold, release the levers **A** shown by pressing them together, rotate the rear tubes until the levers engage in the locked position. To fold the chassis simply reverse this procedure.

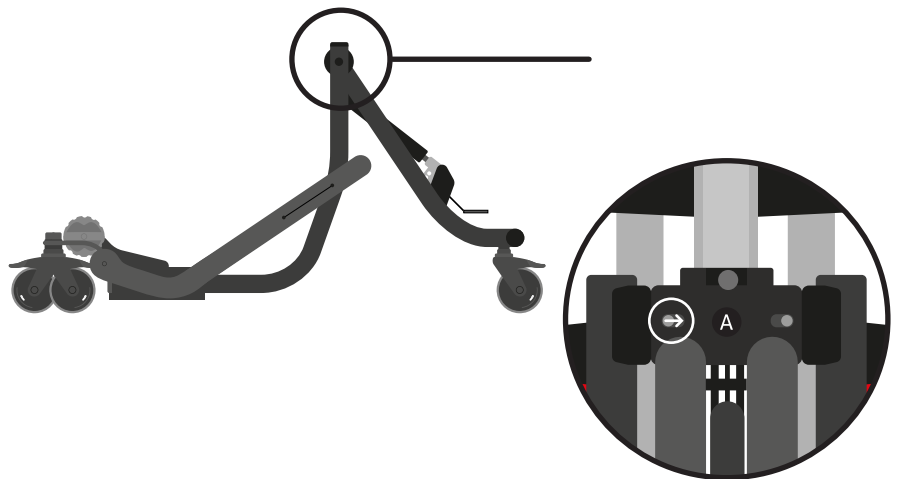

**Always remove the standing support frame before trying to fold the chassis.**

**Always use caution to ensure fingers do not become trapped when folding and unfolding the pivot chassis.**

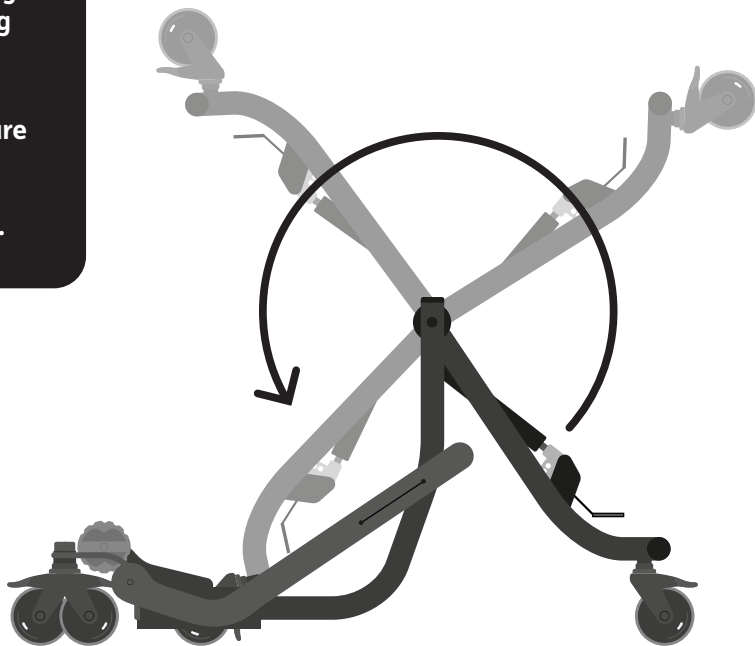

The Squiggles TT has been designed to fit with a pivot chassis.

### 9.2 Attaching stander to pivot chassis

To attach the stander to the Pivot Chassis, pull the locking pin out **A**, slide the central spine into the receiving bracket until it is fully engaged, release the pin allowing it to snap back into place.

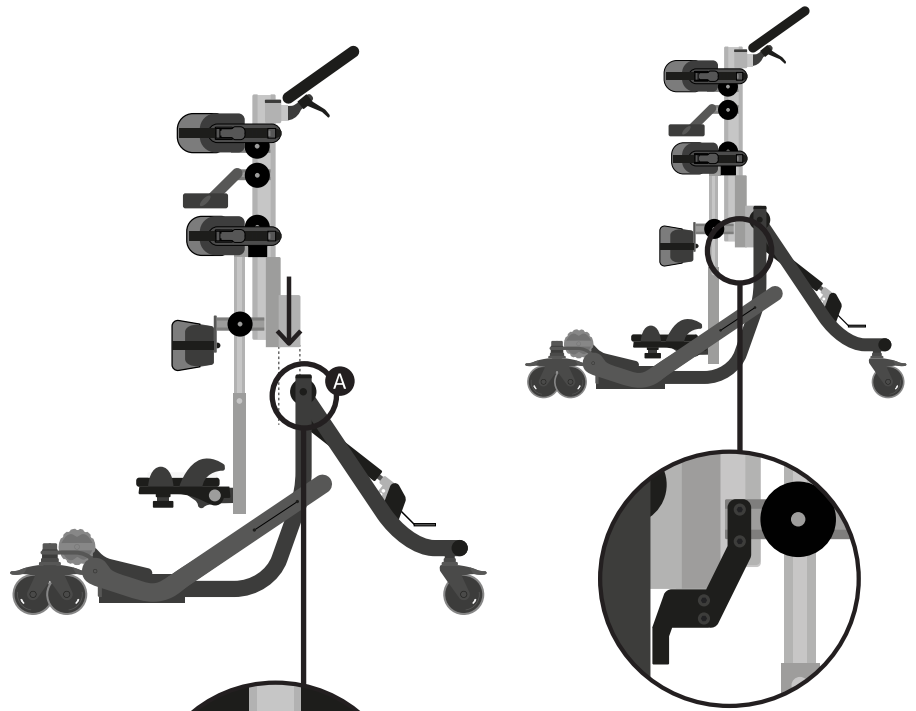

The angle adjustment plate allows the angle of the stander to be changed and set.

To adjust the plate loosen the bolts with the Leckey tool provided.

Slide the plate along the slots until it contacts the upright support at the desired angle.

The position of the assembly can be adjusted up the spine. However this should only be necessary if the spine assembly is adjusted. The plate position relative to the chassis should always be as shown.

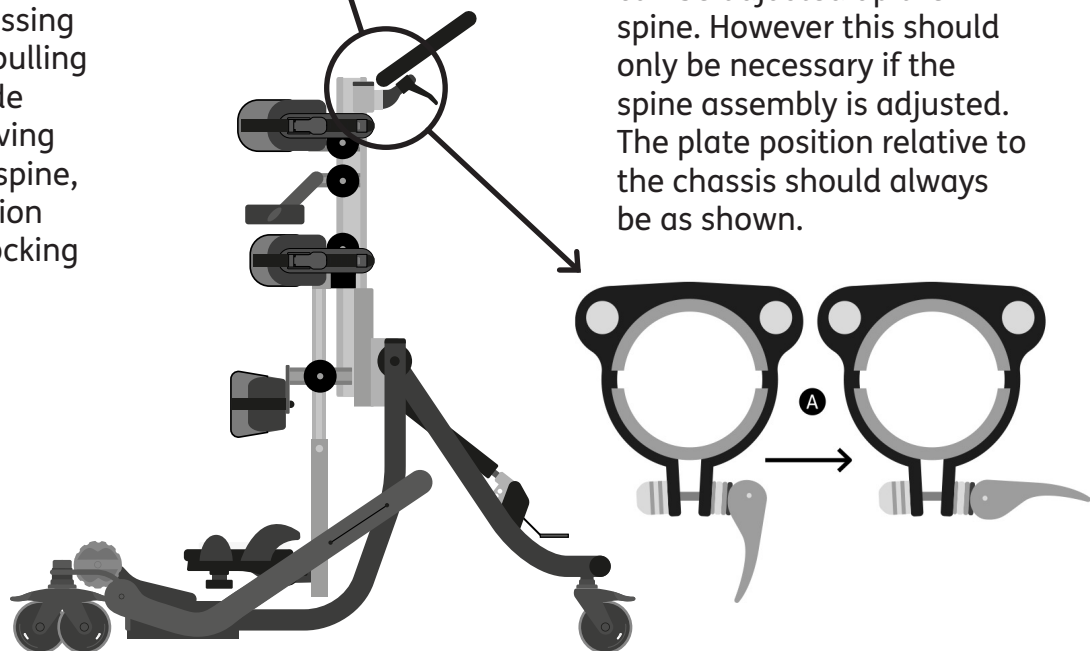
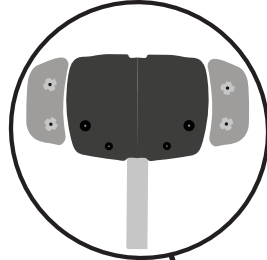
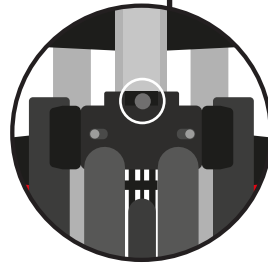



Always make sure the locking pin is fully engaged before you place the child in the stander.

### 9.3 Attaching the horizontal support

To attach the Leckey Horizontal Support first open the locking lever by pressing the safety button and pulling the handle **A**. Then slide the stem into the receiving bracket on the central spine, set to the desired position and secure using the locking handle.

## 9.4 Attaching the headrest

To attach the Leckey headrest first open the locking lever by pressing the safety button and pulling the handle **A**. Then slide the stem into the receiving bracket on the central spine, set to the desired position and secure using the locking handle **B**.

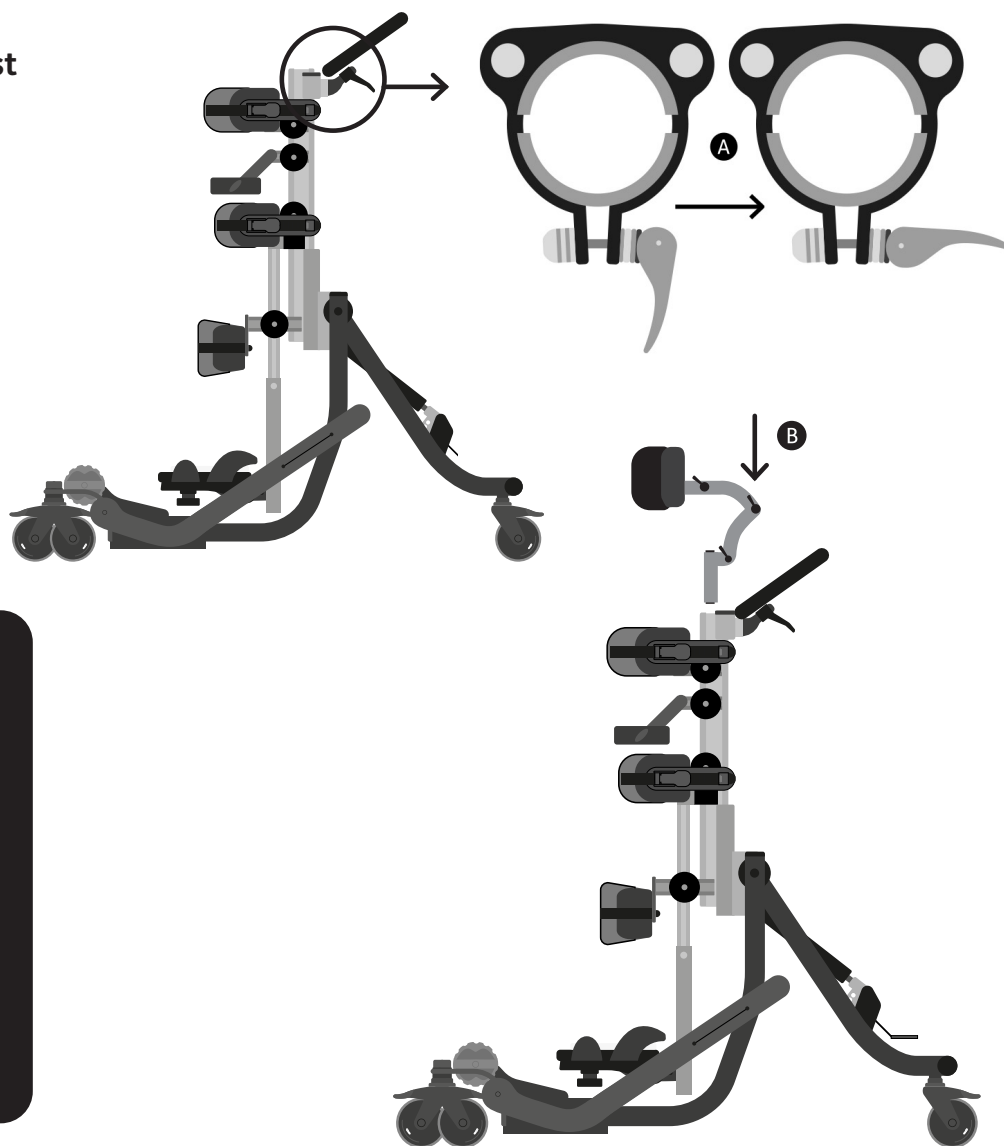

The product contains components which could present a choking hazard to small children. Always check that locking knobs and bolts within the child's reach are tightened and secure at all times.

### 9.5 Inserting sandal attachment bolt

Insert the required attachment bolt **A** along with the retention plate **B**. Place a rubber lid **C** on, both, the top and bottom of the sandal. Fasten using the four screws **D** provided. To remove or replace the attachment bolt, reverse this process.

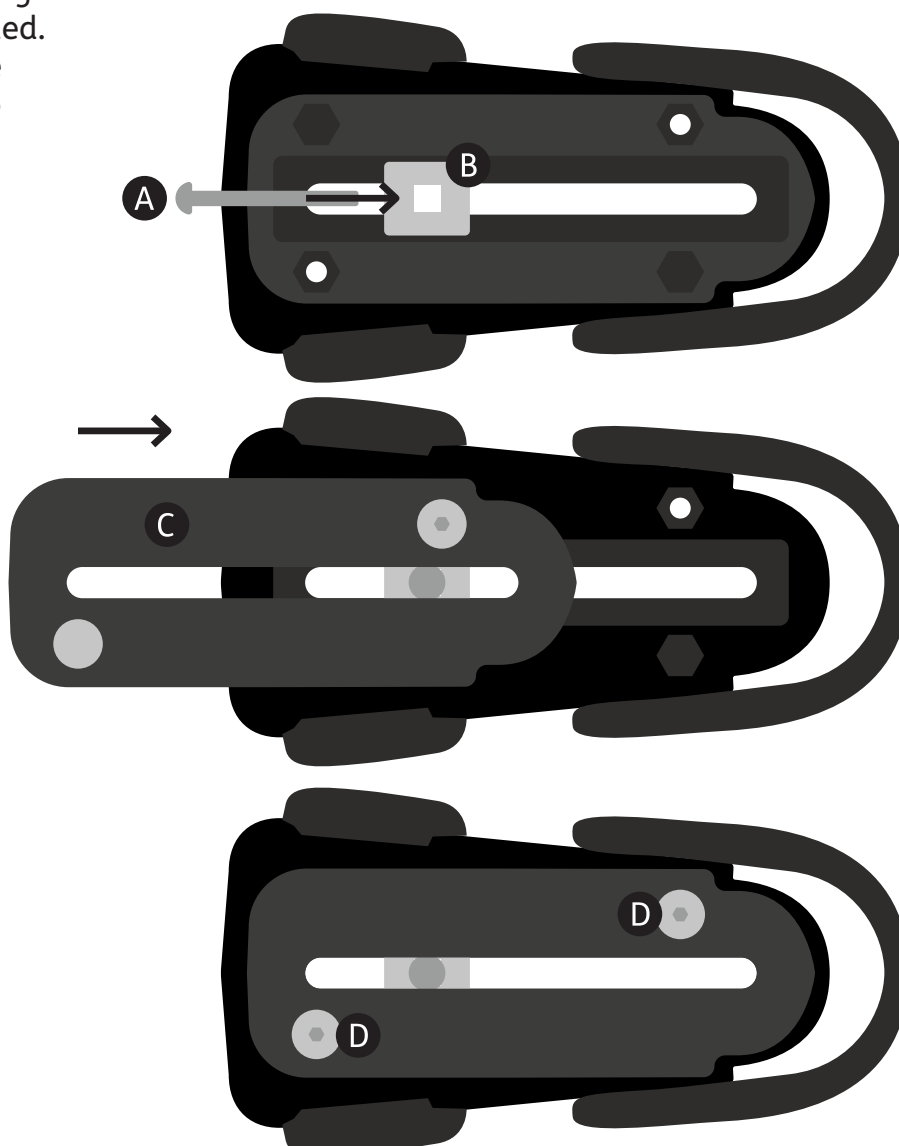

## 9.6 Attaching the sandals

Place the sandal so that the attachment bolt goes through the slot in the footplate. To secure, on the underside of the footplate place the rubber washer **A**, followed by the metal washer **B** and then the knob **C** onto the attachment bolt. To position the sandals simply loosen the knob under the footplate, select the position you require and re-fasten the knob.

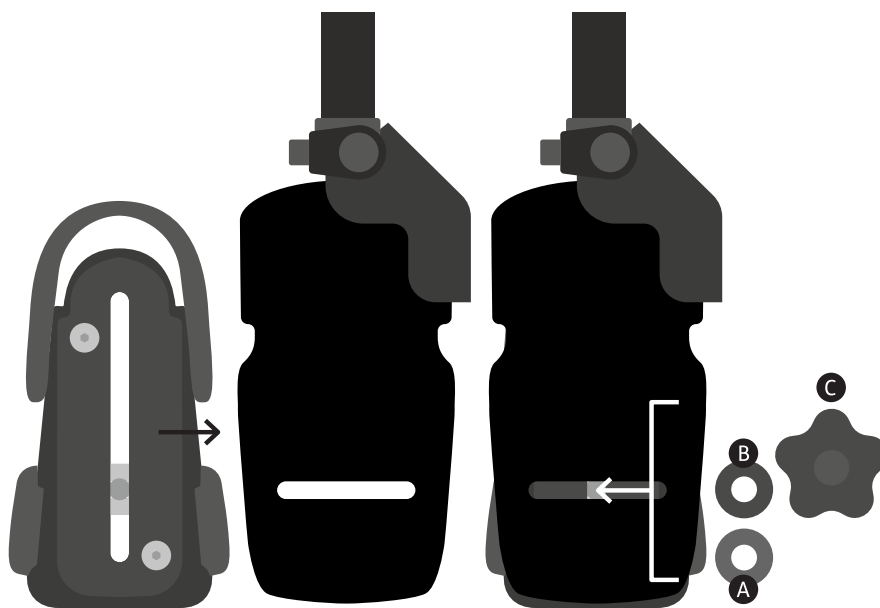

## 9.7 Assemble the tray

To attach the arms to the tray brackets, loosen the knob, place the moulding to the inside of the tray plate so the plastic teeth mesh **A**. Replace the knob on the outside and secure. Repeat on other side. Ensure both horizontal tubes are aligned so they locate in the tray bracket receivers **B**.

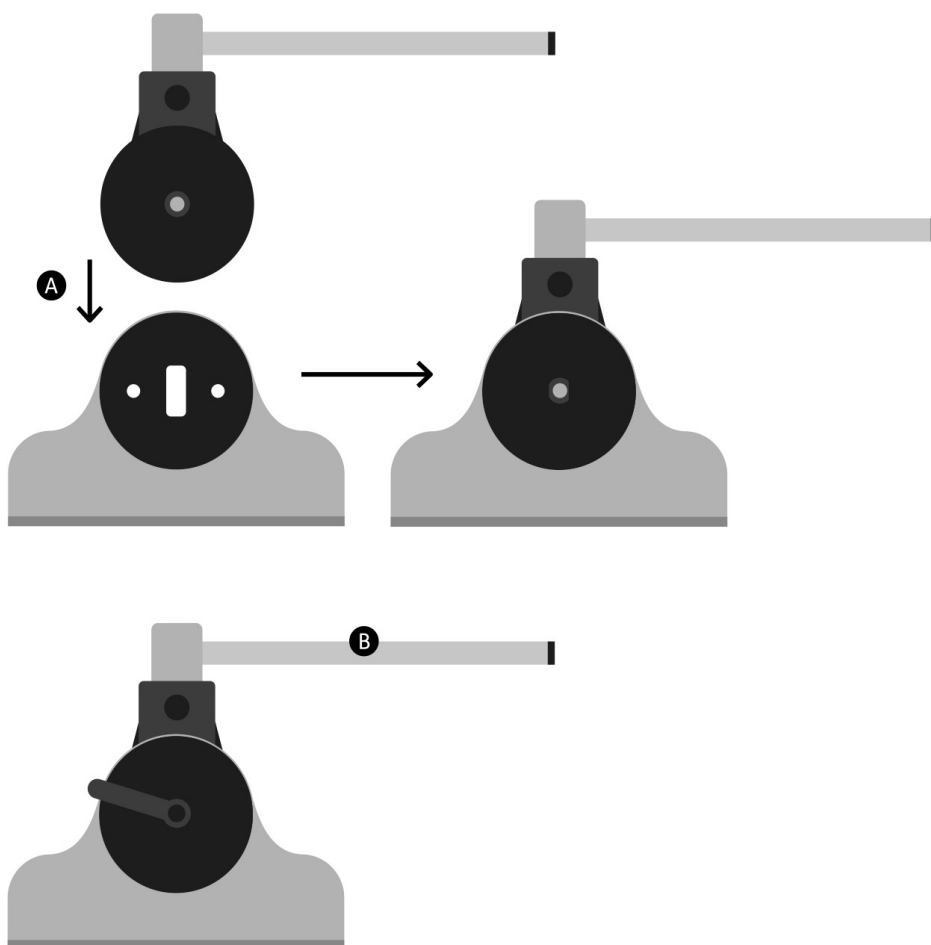

Please be aware of a gap on the underside of the tray where a child could insert their finger between the metal bracket and the base of the plastic tray.

### 9.8 Attaching the tray in supine

The tray is attached to the stander by inserting the tubes into the receiving brackets. Once the tray is located in position the knobs should be tightened. The cut out of the tray should always be facing the child. To attach the tray ensure that the tray receiving tubes are at their maximum height.

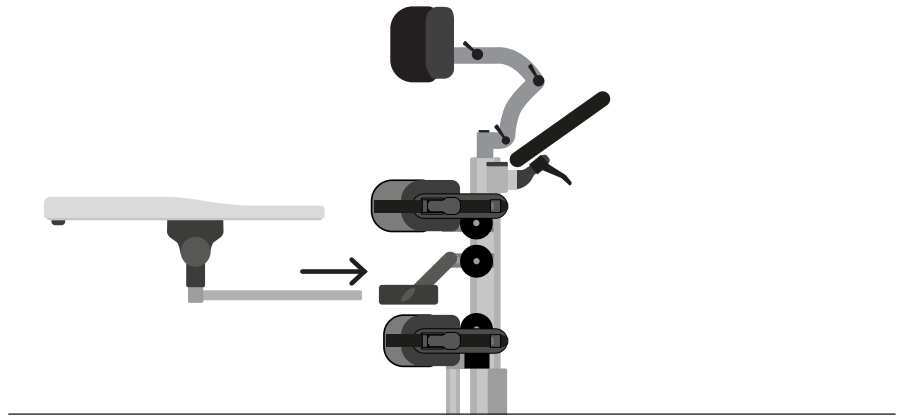



**Always use caution to ensure the child's hands or arms do not become trapped when inserting the tray.**

# 10.0 Fitting the Cushions

## 10.1 Knee support pads

Unscrew the washer and bolt from the knee cup using the Lecky tool **A**. Ensure the buckles are facing away from the frame. Holding the knee cup in position against the plate, place the washer and screw into position on the other side and secure together **B**. When secured in place, adjust as needed. Once knee is in correct position, secure cam-lock for further repeatability **C**.

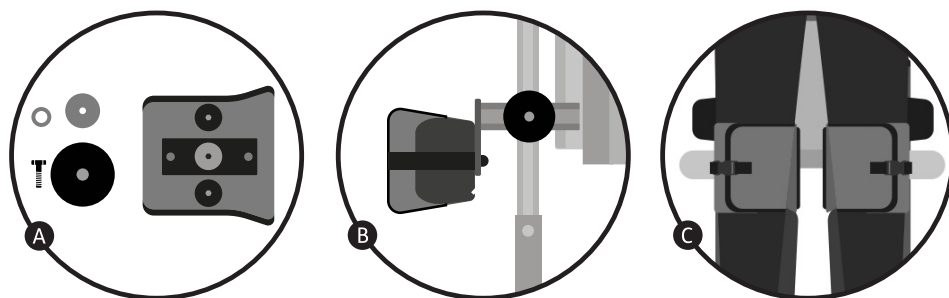

## 10.2 Padded Spine Cap

Place the padded spine cap over the spine of the standing support and place the plastic loops around the adjustment knobs.

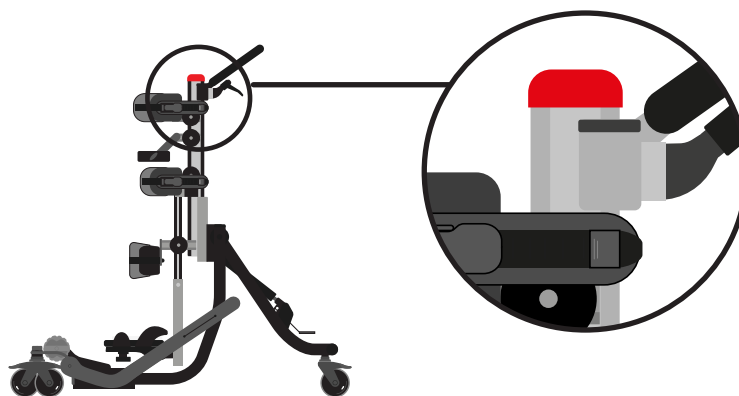

## 10.3 Headrest cushion

To attach the headrest cushion, place the cushion onto the head support plate, then Velcro and bring the lower flap under the plate and Velcro the two fasteners in place.

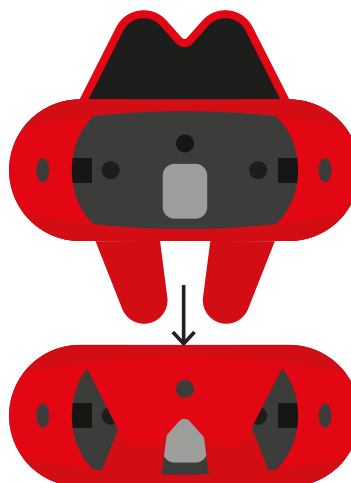

### 10.4 Attaching the lateral covers

Slide the cover over the front of the lateral.

Pull the tabs around the back and secure the Velcro in place.

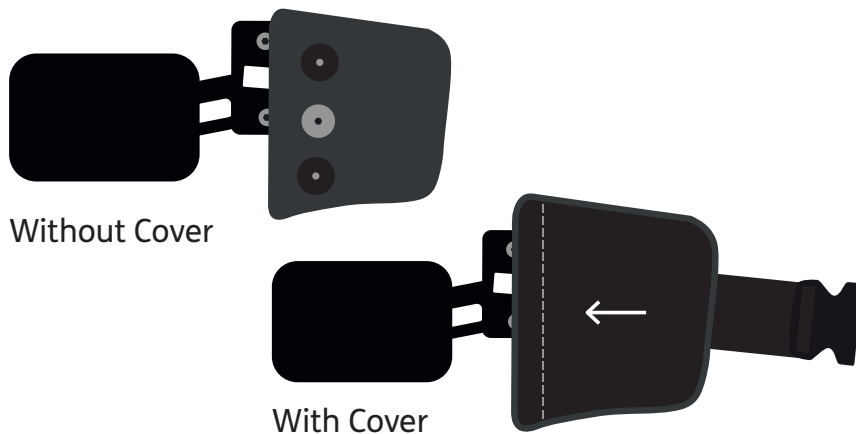

### 10.5 Horizontal support cushion

Slide the cushion over the horizontal support plate.

Feed the Velcro flaps through the groove at the back and secure in place.

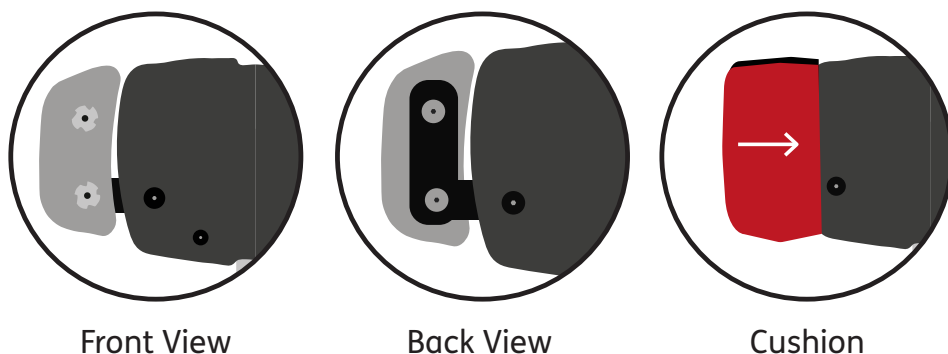

### 10.6 Pelvic and Trunk wrap

Fit the cushion over the plastic support **A**.



Cushion

Slide the tab up from below and attach the velcro to the tab over the top **B**.



Trunk Wrap



Pelvic Wrap

Screw the wrap to the plate through the holes on the wrap. Tighten until secure, ensuring not to over tighten **C**.

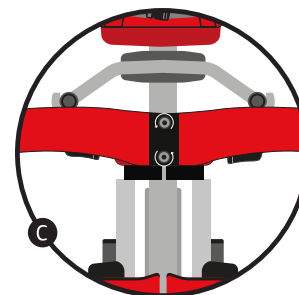
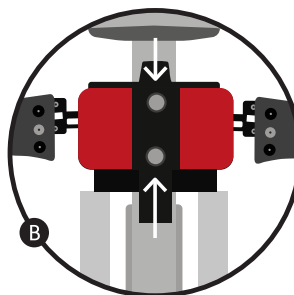
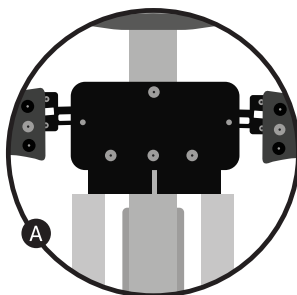

Cover the screws with the padded Velcro tab **D**.

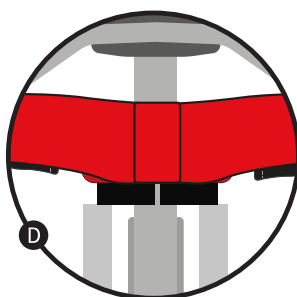

# 11.0 Clinical setup

## 11.1 Before you start

It is recommended before setting up the Squiggles TT that a mat assessment is done. To do this, place the child in supine (lying on their back) on the mat. You will need to measure from the bottom of the child’s foot in a neutral position to the child’s ASIS **A**. This will be the height between the centre of the PELVIC SUPPORT and the top of the sandal. It can be set by adjusting the leg supports **B**. Measure the distance from the child’s ASIS to the point where they start to lose trunk control (see ‘SATCo’ assessment). This will be for the placement of the TRUNK SUPPORT **C**. Measure from the bottom of the child’s foot to the centre of the knee. This will be for placement of knee supports. It’s recommended to adjust the height whilst the frame is in an upright position.

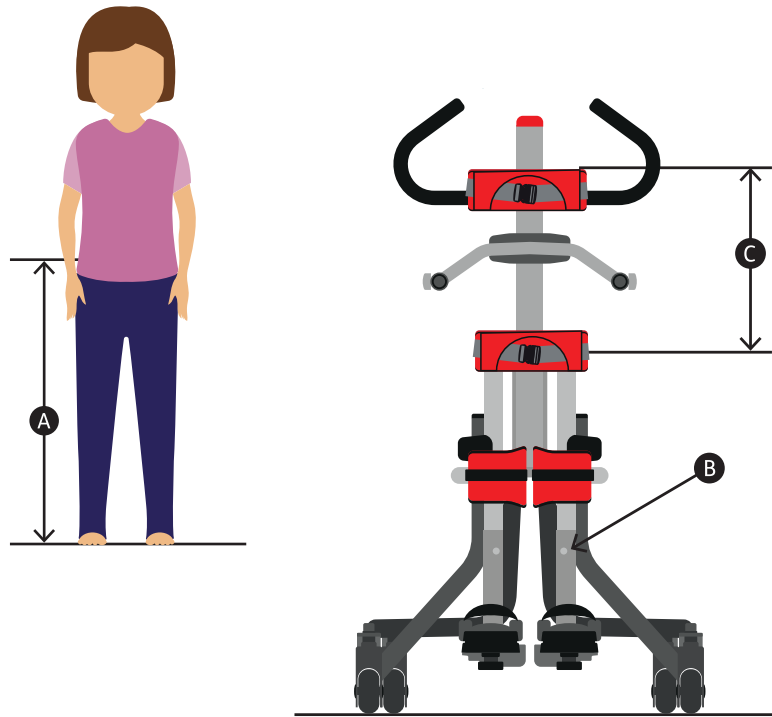

## 11.2 Adjusting the overall height

The overall height of the standing support can be adjusted by loosening the bolt on the back of the main frame with the multi-tool **A**. Sliding the inner stem to the desired height and re-tightening the Allen bolt. A calibration strip is fitted on the side of the inner frame to help you record the selected positions of the supports. There is also a safety stop at the maximum height.

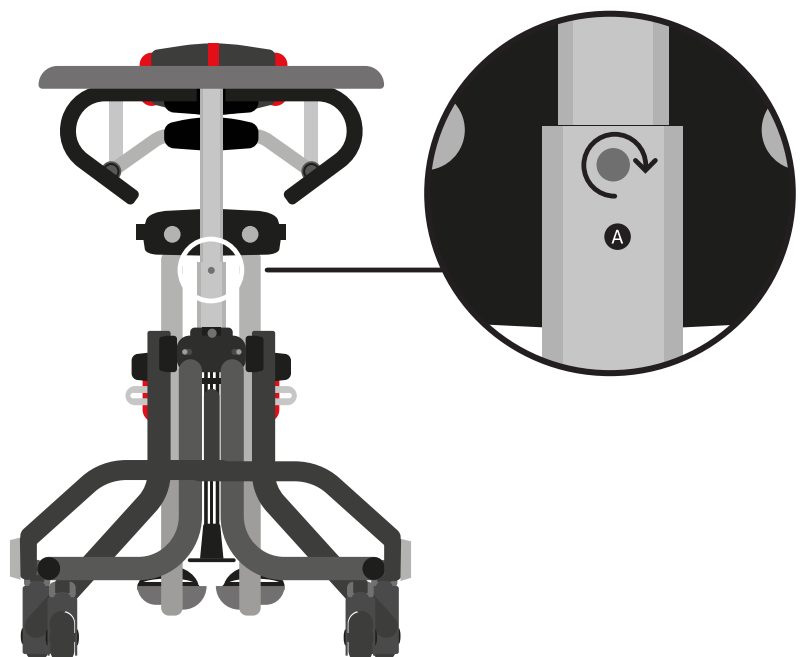

### 11.3 Adjusting the push handle

The push handle height can be adjusted by loosening the Allen bolt **A** at the attachment point to the stander, adjusting to the desired height then re-tightening the Allen bolt. The angle of the push handles can be adjusted by loosening lever **B** at the attachment point to the stander. Rotate the push handle to the desired position, then secure the lever to original orientation.



To prevent finger nipping always hold the push handle with one hand whilst making the adjustment with your other hand.

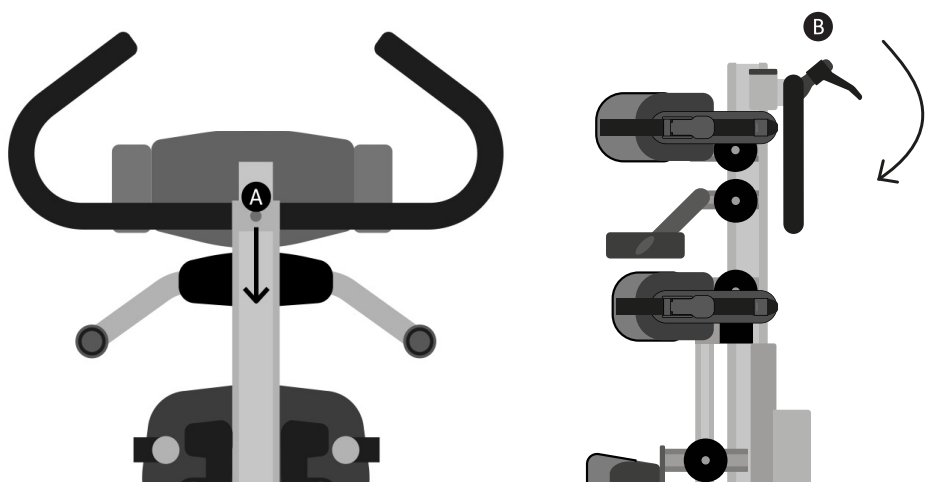

### 11.4 Adjusting the trunk and pelvic supports

To adjust the trunk support rotate both knobs **A** in an anticlockwise direction as shown. Set to the required position and then re-tighten both knobs in a clockwise direction as shown **B**.

To adjust the pelvic support loosen the 4 locking bolts (2 either side) **C**. Rotate both knobs **D** in an anticlockwise direction as shown. Set to the required position and re-tighten both knobs in a clockwise direction as shown **E**. Finally re-tighten the 4 locking bolts.

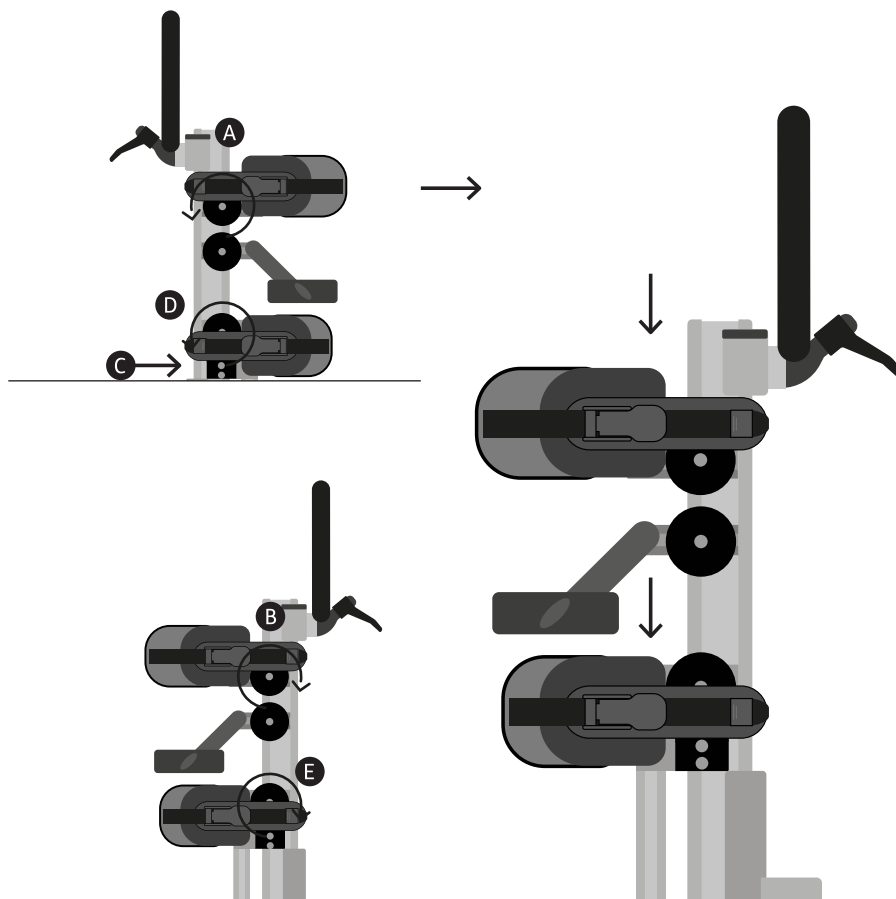

Always use caution to ensure fingers do not become trapped when adjusting the trunk and pelvic supports.

### 11.5 Lateral supports

Loosen the hand knob **A** to adjust the width of the lateral supports and re-tighten when you have achieved the desired position. If the lateral supports are attached with bolts instead of hand knobs they can be adjusted with the multi tool.

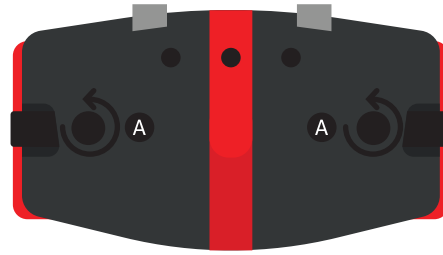



Always use caution to ensure fingers do not become trapped when adjusting the lateral supports.

### 11.6 Adjusting the height, depth and angle of the knee cups

Each knee cup can be positioned independently. To adjust the height, depth and angle of the knee cups, loosen screw **A**, select the height, angle and depth required and re-tighten the screw securely. To adjust the width of the knee cup loosen screw **B**, set to the desired width then re-tighten.

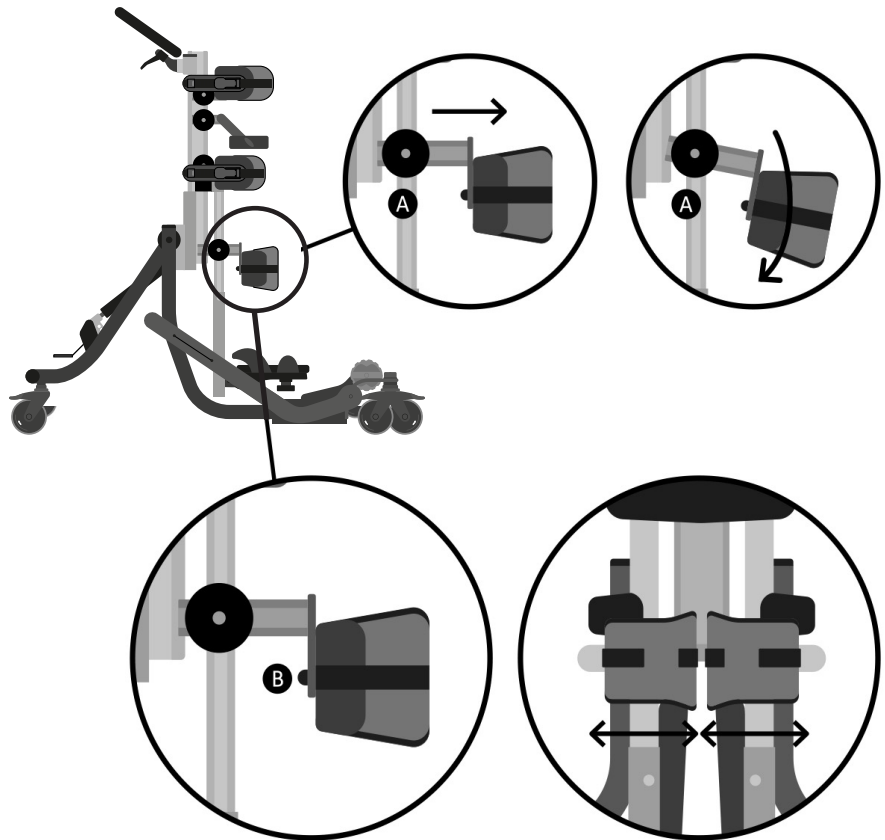

### 11.7 Headrest adjustment

The headrest should only be used for horizontal transfer and when the child has poor head control and needs training in this segment. To adjust the height, depth and angle of the contoured headrest, loosen the hand knobs **A** and when set to the desired position re-tighten the knobs.



Always use caution to ensure fingers do not become trapped when height adjusting the headrest.

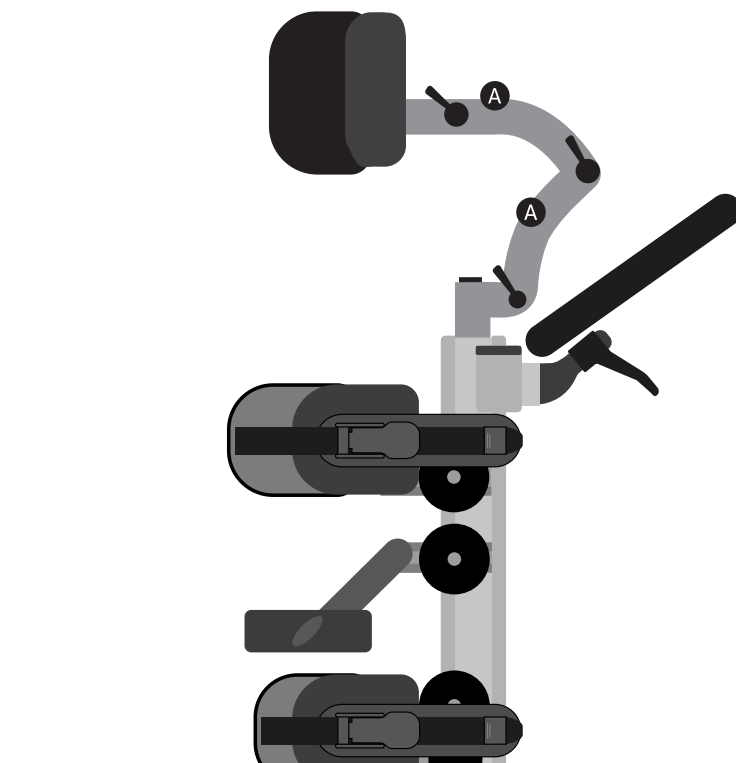

### 11.8 Flat headrest lateral adjustment

To adjust the width of the laterals loosen plastic knob **A** to desired position and tighten securely.

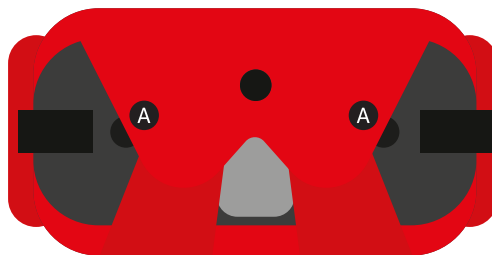

### 11.9 Sandals positioning

To position the sandals simply loosen the knob **A** under the footplate, select the position you require and re-fasten the knob. To position the user's feet in the sandals secure the Velcro straps provided so the foot is held in place. The straps should be placed over the bridge of the foot and over the toes. The front strap can be fed through one of two slots on either side of the sandals, depending on the size of the user's feet.

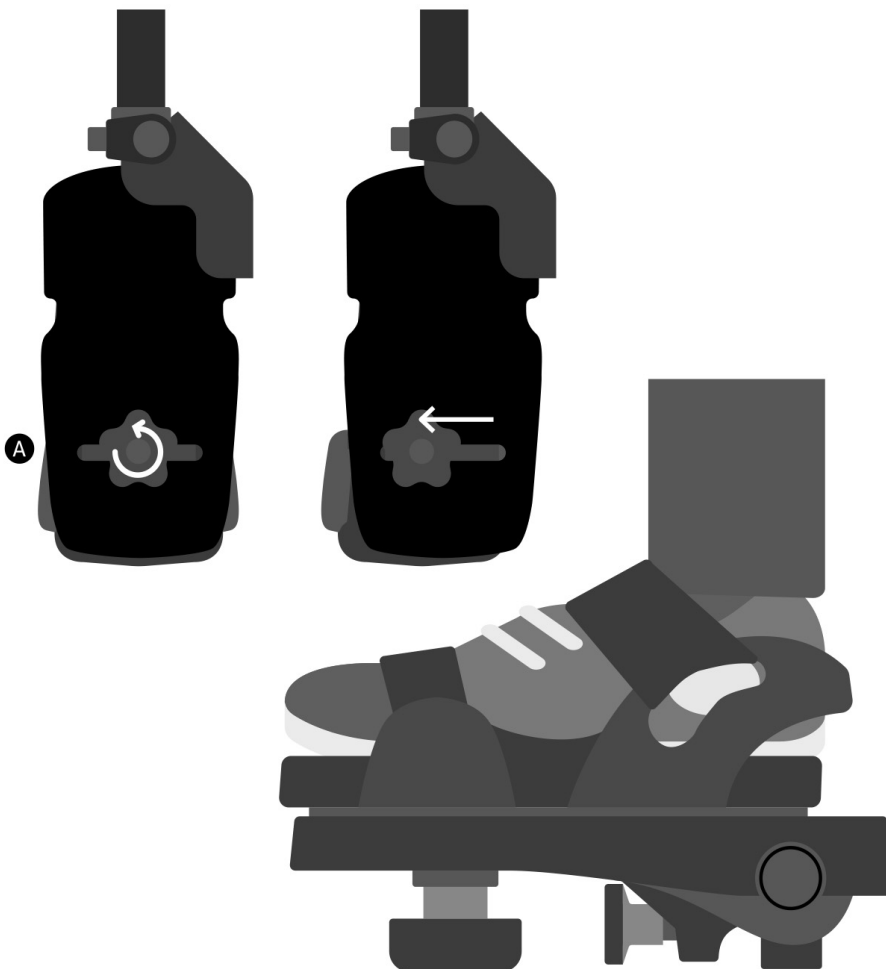

**If the child is wearing sandals or light footwear check the straps to make sure the webbing does not irritate the skin.**

### 11.10 Footplate angle adjustment

To set the angle to accommodate plantarflexion and dorsiflexion, simply loosen or tighten the knob **A** to set the desired angle.



### 11.11 Adjusting for abduction

Squiggles TT has not been specifically designed to provide abduction, however, adjustments can be made to facilitate this. Loosen levers A on each leg support. Adjust leg support to desired angle. Re-tighten levers.

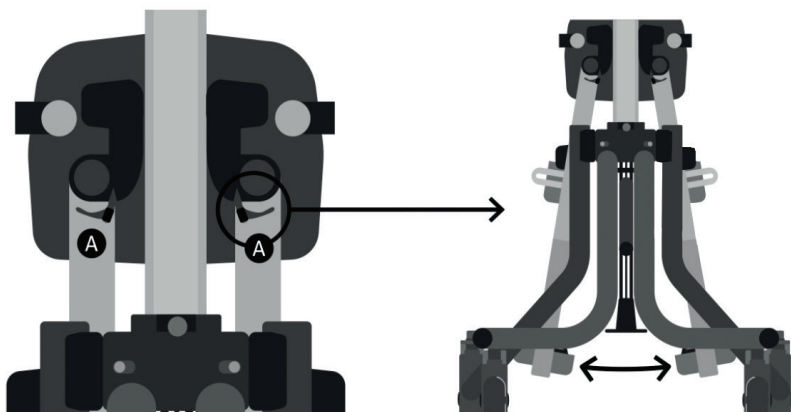

### 11.12 Adjusting the height of the tray

The height adjustment knobs for the tray are located on either side of the central spine. Loosen the 2 knobs A, select the required height and re-tighten.

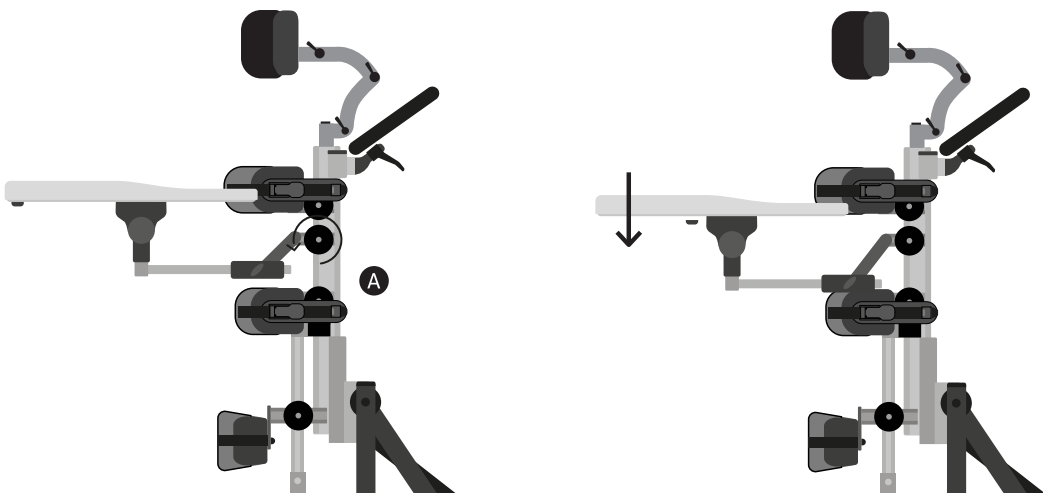

### 11.13 Adjusting the depth and angle of the tray

Loosen the adjustment knob A on either side, slide the tubes along the receiving brackets to achieve the desired depth and re-tighten the knobs. To adjust the angle of the tray loosen the knobs B on either side of the tray, set the tray to the required angle and re-tighten.

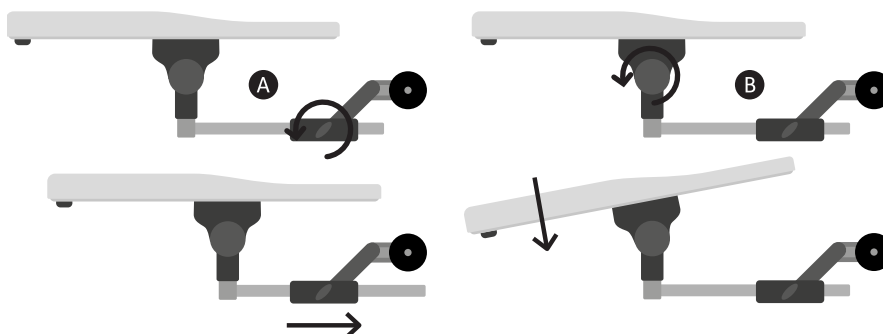

# 12.0 Adjustment for daily use

## [therapists/carers/parents]

Parents and carers should be shown how to make adjustments and made aware of the safety checks in section 7 by a technically and clinically competent person who has been trained in the use of the product. Leckey recommend that a written record is maintained of all parent and carers who have been trained in the use of this product.

### 12.1 Before transferring in to the Squiggles TT

Ensure the dynamic base is in a stored position **A** (white marker on the dynamic base) before transferring the child in to it. Carry out the daily product inspection as outlined in section 14 of this user manual. Lock all the castors **B**, ensuring that they are facing outwards to maximise product stability.

Unlock the break release point **C**. While pressing down on the break, pull the handles down so that the Squiggles TT is almost horizontal (5 degrees off horizontal). Make sure the straps on the trunk and pelvic supports are released and out of the way to facilitate transfer. Transfer child in to the Squiggles TT.

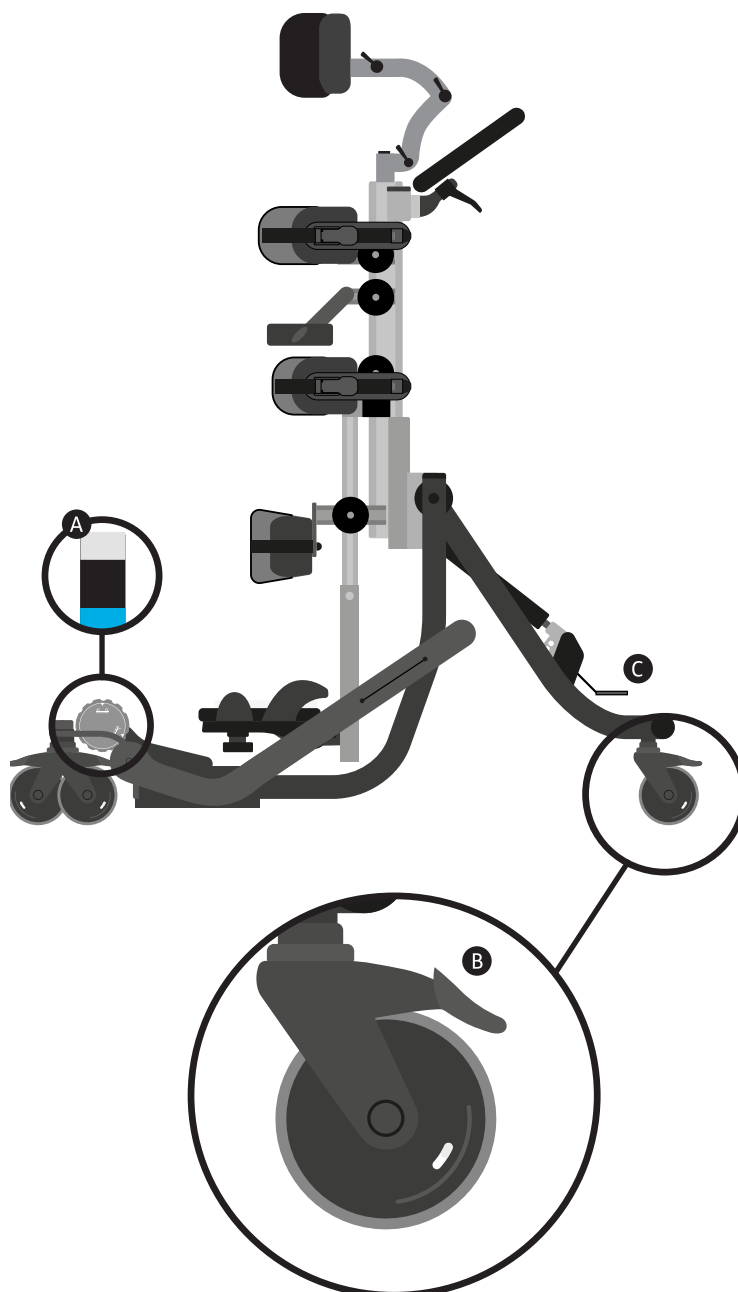

## 12.2 Pelvic support

Ensure the ratchet straps are unlocked **A**. Thread the clip and buckle through each side of the pelvic wrap and secure around child's hips **B**. Push down on the ratchet strap from above to tighten further **C**. This should be tight but not uncomfortable.

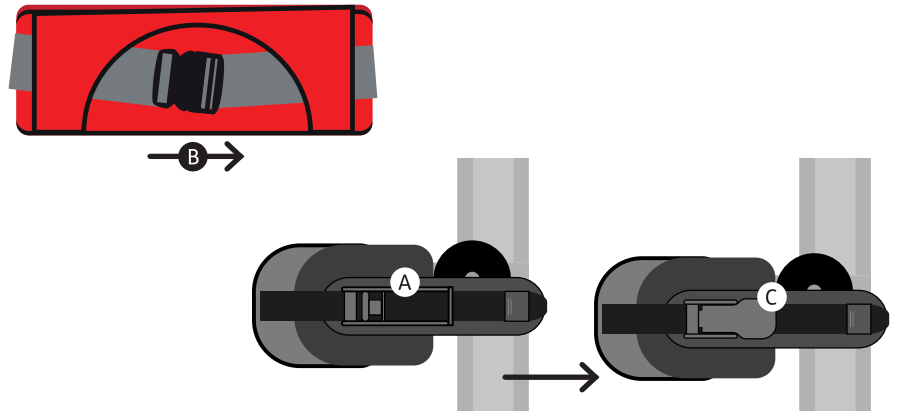

## 12.3 Knee support pads and sandals

To position the user's feet in the sandals, secure the Velcro straps provided so the foot is held in place. The straps should be placed over the bridge of the foot and over the toes. The front strap can be fed through one of two slots on either side of the sandals, depending on the size of the user's feet. Place the child's knees in the supports and secure.

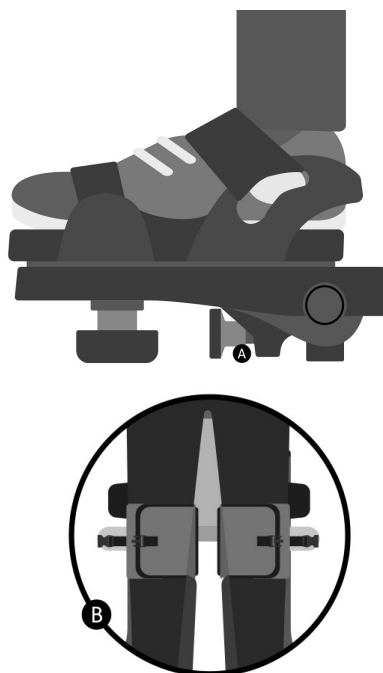

Open the knee supports fully. Insert child's knee into place. Wrap small strap over the knee, then bring the longer wrap over to ensure a snug fit over the knee. Velcro in place and secure with buckle.

Once knee is in correct position, secure cam-lock for further repeatability.

## 12.4 Trunk support

Ensure the ratchet straps are unlocked **A**. Thread the clip and buckle through each side of the trunk wrap and secure around child's trunk **B**. Push down on the ratchet strap from above to tighten further **C**. This should be tight but not uncomfortable.

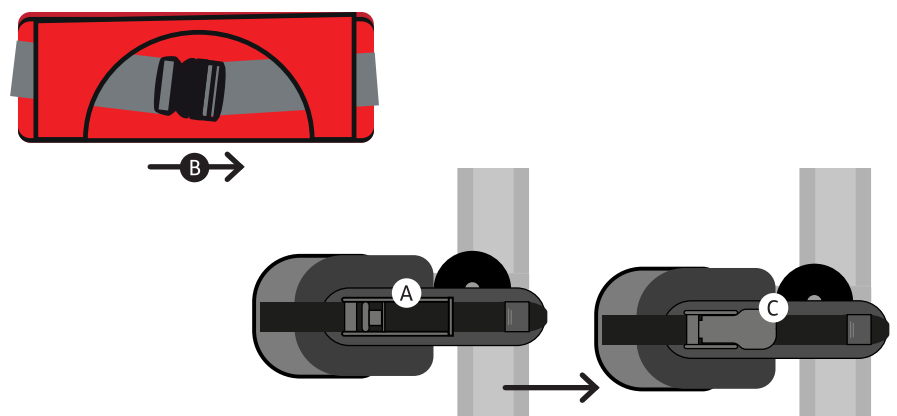

### 12.5 Head support and horizontal support

Keep this in position until the child is fully upright and then remove horizontal support. Keep headrest in position if the child has no/poor head control **A**. If appropriate, remove the head rest and horizontal support and place the spine cap over the top of the spine **B**.

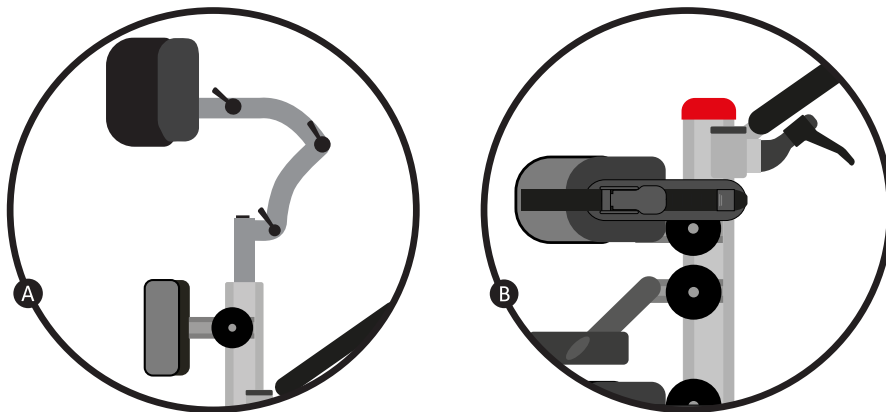

### 12.6 Bringing the child upright

Press the brake **A** and push the handle bars up until the child is upright. Ensure the brake is fully engaged before letting go of the handles.

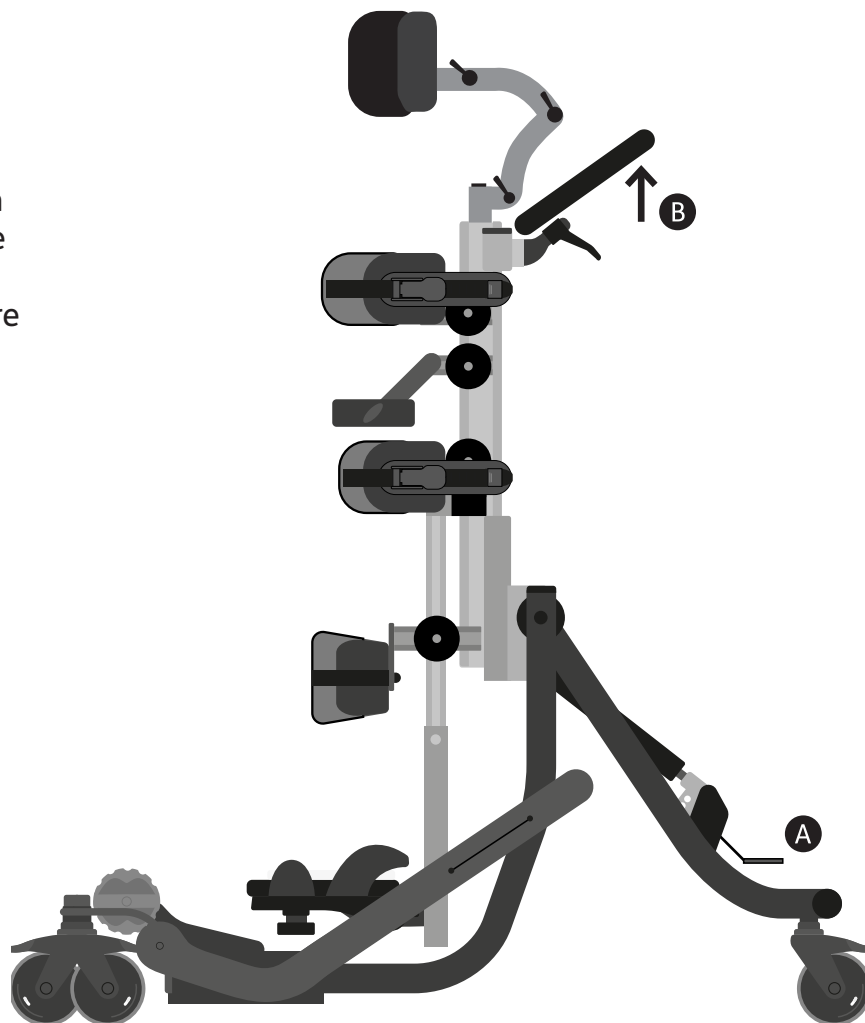

## 12.7 Dynamic base:

### To engage the dynamic base:

Turn the dials **A** on the Left and Right Hand Side of the rocker base so that the 'rocker' symbol **B** aligns with the marker **C**.

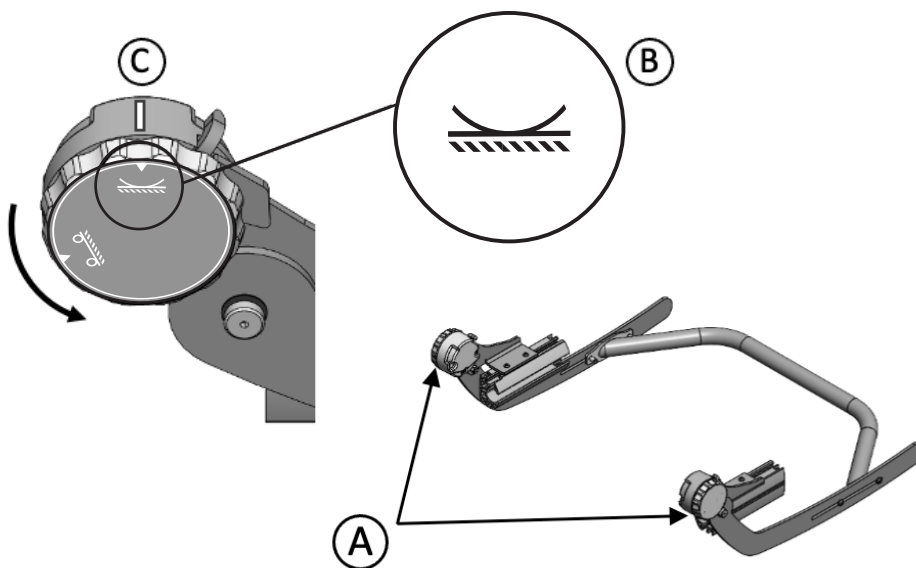

While supporting the weight of the rocker bar, unclip the white buckle **D**, and allow the rocker bar to drop to the ground.

Place your foot on the back of the rocker bar **E** and push downwards, meanwhile lift the Squiggles TT handles upwards and forwards **F**, until you hear a click. This is now engaged (blue on indicator).

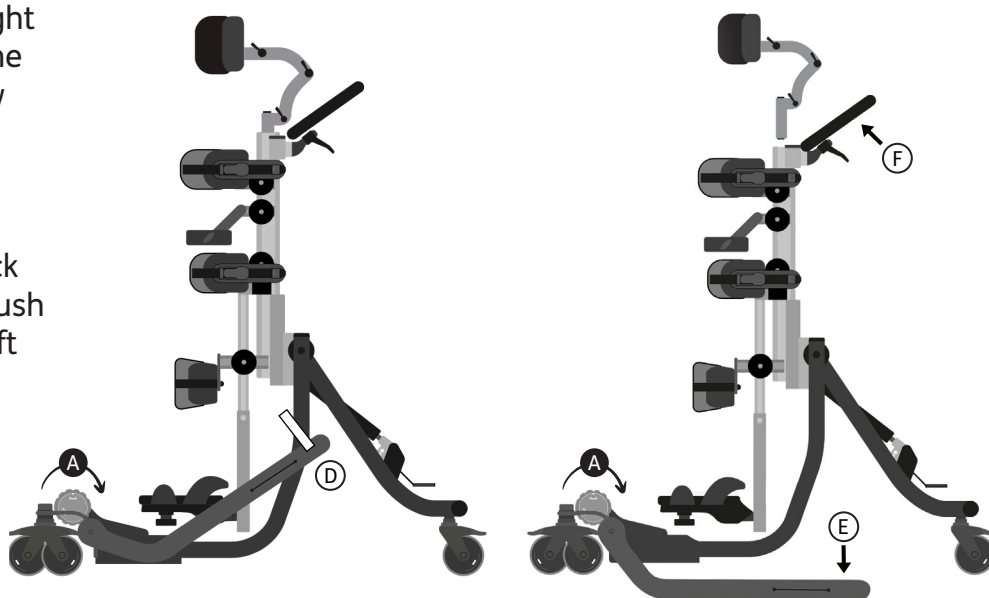

**Check:** When the rocker is in the engaged position, the indicators **G** on the Left and Right Hand Side are blue.

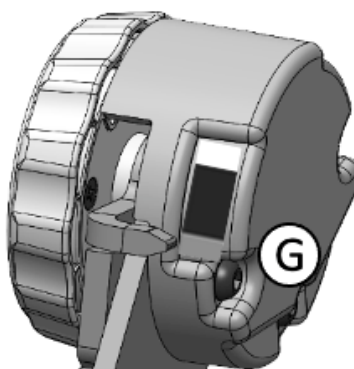

## 12.7 Dynamic base:

### To disengage the dynamic base:

Turn the dials **A** on the Left and Right Hand Side of the rocker base so that the 'wheels on the ground' symbol **B** aligns with the marker **C**.

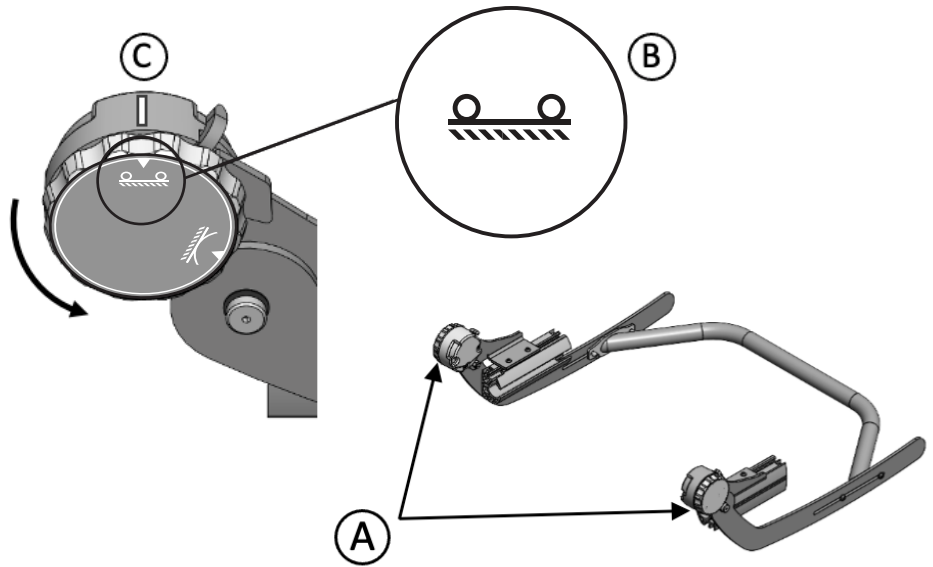

Place your foot on the back of the rocker bar **D** and push downwards, meanwhile lift the Squiggles TT handles upwards and forwards **E**, until you hear a click. Support the weight of the stander downwards until the wheels are on the ground.

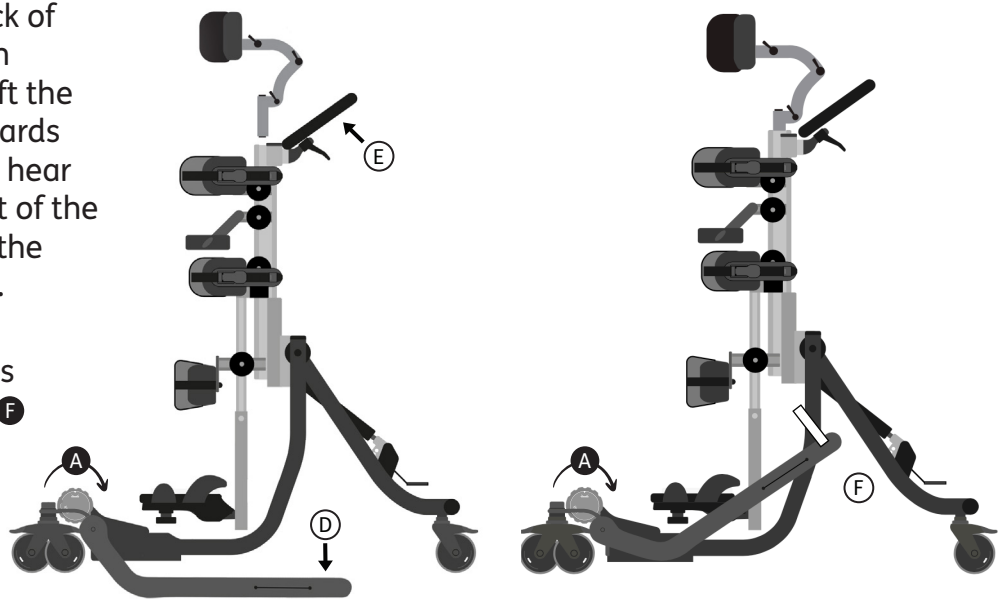

Lift the rocker bar upwards and clip the white buckle **F** around the rocker bar.

**Check:** When the rocker is in the disengaged position, the indicators **G** on the Left and Right Hand Side are white.

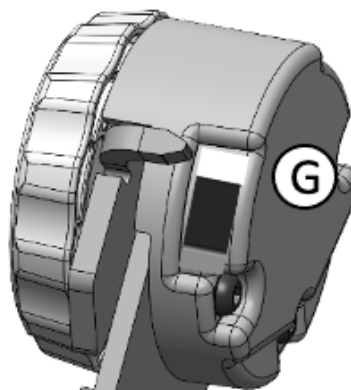

---

# 13.0 Cleaning & Care Information

---

## How to Maintain

When cleaning we recommend that you use only warm water and a non-abrasive detergent. Never use organic solvents or dry cleaning fluids.

---

## Upholstery and fabrics

1. The upholstery and fabrics can be cleaned by hand whilst in place. When cleaning we recommend that you use only warm water and a non-abrasive detergent.
  2. The best cleaning method is a 'wipe & dry' technique.
  3. Staining should be removed as quickly as possible with absorbent cloth, towels or a sponge. Routine soap and warm water sponging is effective for ordinary soiling and minor spills. Be careful not to over wet the fabric as this will cause the staining to spread.
  4. Antiseptic cleaning agents can be used on more stubborn stains. These may require a safe solvent such as Isopropyl Alcohol or Mineral Spirit. A half cup of household bleach to 5 litres of water can also be used as a useful disinfectant.
  5. Always ensure the product is dry before use.
- 

## Metal and plastic components

1. Soap and water or antibacterial spray can be used for daily cleaning.
2. For deep cleaning a low pressure steam cleaner can be used.
3. Do not use solvents to clean plastic or metal components.
4. Make sure the product is dry before use.

# 14.0 Daily Product Inspection

---

## Therapists, parents & carers

We recommend that daily visual checks of the equipment are carried out by therapists, carers or parents to ensure the product is safe for use. The recommended daily checks are detailed below.

1. Ensure all adjustment knobs and bolts are in place and secure.

---

2. Check all upholstery for signs of wear and tear.

---

3. Check all castors are moving freely and lock securely.

---

4. Check all Velcro strips and brush fluff to ensure straps secure firmly.

---

If in any doubt to the continued safe use of your Leckey product or if any parts should fail, please cease using the product and contact our Customer Care Team or your local dealer as soon as possible.

---

# 15.0 Annual Product Inspection

---

## **(Therapist, Technician, Product Specialist, Dealer)**

Leckey recommend that each product should be subject to a detailed inspection at least once a year and every time the product is reissued for use. This inspection should be carried out by a technically competent person who has been trained in the use of the product and should include the following checks as a minimum requirement.

1. Check all knobs, nuts, bolts and plastic buckles are in place, replacing any missing items. Paying particular attention to the following items; > Headsupport locking bolts > Chest and hip height and angle adjustments > Knee cups adjustment knobs and straps > Footrest angle adjustment.

---

2. Check the chassis folding and angle adjustment mechanism is working properly. Also, check that the locking pin on the Pivot Chassis engages securely in the pedal.

---

3. Lift the base to check each castor individually. Make sure they are moving freely and remove any dirt from the rubber wheels. Check that the brakes lock the wheels securely.

---

4. Visually check the structure of the product paying attention to weld points on the frame ensuring there are no signs of fatigue or cracking around the welds.

---

5. Leckey recommend that a written record is maintained of all annual product inspections.

---

If in any doubt to the continued safe use of your Leckey product or if any parts should fail, please cease using the product and contact our Customer Care Team or your local dealer as soon as possible.

# 16.0 Re-issuing Leckey Products

---

Most Leckey products are assessed and ordered to meet the needs of an individual user. Before reissuing a product we recommend that the therapist prescribing the product has carried out an equipment compatibility check for the new user and has ensured that the product being re-issued contains no modifications or special attachments.

A detailed technical inspection should be carried on the product prior to re-issuing. This should be carried out by a technically competent person who has been trained in the use and inspection of the product. Please refer to section 15 for the required checks to be carried out.

Before re-issuing a product, it is recommended that it is disinfected using one of the following procedures:

**Note: Always clean the product first to remove accumulated soiling prior to disinfecting/sanitising.**

1. Where possible, we recommend the use of an automated “fogger” disinfection system that is used to completely cover the product surfaces with a disinfectant agent. The manufacturer’s instructions for the chosen system should be referred to prior to use and followed exactly.
2. Where an automated disinfection system is not available, all product surfaces should be wiped over with disinfectant surface wipes or liquid disinfectant on a soft cloth. Suitable products are 70% IPA, 70% Alcohol or diluted bleach. The manufacturer’s instructions for the chosen product should be followed. Product upholstery and fabrics should be cleaned thoroughly in accordance with section, Cleaning and Care Information, of this manual.

Ensure a copy of the user manual is supplied with the product. A copy can be downloaded from our website [www.leckey.com](http://www.leckey.com).

Leckey recommend that a written record is maintained of all product inspections carried out during the reissue of the product.

If in any doubt to the continued safe use of your Leckey product or if any parts should fail, please cease using the product and contact our Customer Care Team or your local dealer as soon as possible.

# 17.0 Product Servicing

---















Servicing of all Leckey products should only be carried out by technically competent persons who have been trained in the use of the product.









All international service enquiries should be directed to the appropriate Leckey distributor who will be delighted to assist you. For further information on Leckey distributors please visit our website [www.leckey.com](http://www.leckey.com).

# 18.0 Technical Information

Age (approx.)	1-5
Max User Weight	22kg / 48.4lbs
User Height	Min 730mm / 28.5 inches Max 1100mm / 43.3 inches
Trunk Support Height (Distance from footplate to armpit)	Min 460mm / 18.1 inches Max 840mm / 33.0 inches
Trunk / Pelvic Width	Min 135mm / 6.25 inches Max 250mm / 9 inches
Pelvic Support Height (Distance from footplate to mid-buttock)	Min 360mm / 14.1 inches Max 600mm / 23.6 inches
Distance between mid line of knees	Min 140mm / 5.5 inches Max 215mm / 8.4 inches
Footplate	Plantarflexion 10° Dorsiflexion 10°
Pivot chassis angle range	90-180° 90 - 70°
Tray height - supine	Min 480mm / 18.5 inches Max 825mm / 32.5 inches
Pivot chassis footprint (Minimum dimensions for storage)	Min 5.5kg / 12.1lbs Width 660mm / 21.7 inches Length 700mm / 27.6 inches Height 300mm / 11.8 inches
Standard support frame (Minimum dimensions for storage)	Min 7kg / 15.4lbs Width 380mm / 15.4 inches Length 890mm / 26.8 inches Height 380mm / 15.4 inches

# Table of Symbols

Symbol	Meaning
	Medical Device
	Read the Instructions for Use
	CE mark
	Warning
	Manufacturer
	Serial number
	Product code
	Max occupancy weight
	Date of Manufacture
	For indoor use only
	Latex free
	Unique Device Identification
	Do not machine wash
	Do not dry clean

Symbol	Meaning
	Do not bleach
	Do not iron
	Do not tumble dry
	Machine wash- water temperature 40°C
	Dry clean- any solvent except tetrachlorethylene
	Machine wash- water temperature 60°C
	Iron- medium temperature
	Drip dry
	UKCA mark





**UK  
CA**

---

**Distributed by:**



**Sunrise Medical Australia Pty. Ltd.**

11 Daniel Street  
Wetherill Park, NSW 2164  
Phone: [02] 9678 6600  
Email: [enquiries@sunrisemedical.com.au](mailto:enquiries@sunrisemedical.com.au)  
Website: [www.SunriseMedical.com.au](http://www.SunriseMedical.com.au)

**Manufactured by:**

**LECKEY**

**Leckey**

19 Ballinderry Road, Lisburn, BT28 2SA  
Northern Ireland, United Kingdom  
Phone: [+44] 28 9260 0750  
Email: [hello@leckey.com](mailto:hello@leckey.com)  
Website: [www.leckey.com](http://www.leckey.com)