



# Squiggles Seat

User Manual



Supporting  
Children



**The Squiggles Seat has been designed to offer a high level of postural positioning while enabling function and mobility. This manual shows how you can quickly, easily and safely make use of all the functions. The instructions on safety and maintenance will ensure that you will enjoy the use of this product for a long time.**

# CONTENTS

01	Intended use
02	Declaration of Conformity
03	Warnings and Cautions
04	Terms of warranty
05	Product history record
06	Product training record
07	Safety information
08	Precautions And Contraindications
09	How to unpack and assemble the Seat
10	Fitting the cushions
11	Clinical setup for postural management
12	Frequent adjustments for daily use
13	Cleaning & care information
14	Daily product inspection
15	Annual product inspection
16	Reissuing Leckey products
17	Product servicing
18	Technical information

## SECTION 01: INTENDED USE

### Intended use

Leckey's seating systems are intended to support children and young adults who have mild to complex postural needs that affect the ability to sit without additional support.

### Indications for use

The Squiggles Seat is a modular Seat designed to cater for the needs of children with a variety of disabilities which effect their ability to sit independently without external postural supports. It is indicated for use primarily within a home, indoor school environment or outdoors, if used on a mobility or stroller base. There is one size; with an approximate age range of 1-5 years with a maximum user weight of 22kgs (48lbs). The configurable postural support offered by the Squiggles Seat is indicated for use for children with moderate to complex postural needs (GMFCS III-V).

## SECTION 02: DECLARATION OF CONFORMITY

The Squiggles Seat is classified as a Class I Medical Device under EU and UK regulations. James Leckey Design Ltd as manufacturer with sole responsibility declares that the Leckey Squiggles Seat conforms to the requirements of the 93/42/EEC Guidelines, Medical Device Regulations 2017, UK Medical Devices Regulation 2002 and EN 12182 Technical aids for disabled persons and test methods.

**Notice to the user and/or patient: Any serious incident that has occurred in relation to the device should be reported to the manufacturer and the competent authority of the Member State in which the user and/or patient is established.**



### NOTE:

#### General user advice

Not following these instructions may result in physical injury, damage to the product or damage to the environment!

## **SECTION 03: WARNINGS AND CAUTIONS**

### **1) WARNING TOPPLING HAZARD**

- Using the seat in extremes of its range of positions will reduce its stability. Only use the seat at maximum height and/ or maximum seat recline when on level ground (less than 2-degree slope).
- When using the seat on slopes/ramps (up to 10 degrees) ensure that the seat back is in the upright position and the seat height is below half height.

### **2) WARNING FINGER TRAP HAZARD**

- Take care that the fingers of the operator or children on the floor do not get trapped in the powered seat raising and lowering mechanism.

### **3) WARNING OCCUPANT SECURITY**

- Ensure that all of the occupant harnesses and especially the pelvic belts are fastened and adjusted to hold the occupant securely in place before moving the seat or leaving the vicinity of the static seat.

### **4) CAUTION FINGER PINCH HAZARD**

- Take care when assembling or adjusting the position of the seat components that your fingers do not get pinched when positioning seat components and tightening mountings.

### **5) CAUTION DAILY CHECKS**

- The seat is to be checked daily before use to ensure that all harnesses and

seating elements are securely attached to the seat and chassis. Also check the battery charging cable for signs of damage before use. See section 'Daily product inspection' for details of checks.

### **6) CAUTION TRIP HAZARD WITH POWERED CHASSIS**

- Ensure that battery charging connection for the powered chassis is removed from the seat before moving the seat.

### **7) CAUTION CLEANING**

- Clean the seat regularly to prevent the build-up of dirt on the seating elements and the chassis. Accumulated dirt can prematurely wear the seat cushions and encourage corrosion on the chassis. Only use non-abrasive household cleaners and moist cloths, do not use running water on the upholstery whilst it is still attached to the seat. See section 'Cleaning & care information'.

### **8) CAUTION CLEANING POWER WASHERS/HOSES**

- Do not use hoses or power washers on the frame components, the electric seat lift system is not sealed against running water and may be damaged by water ingress. See section 'Cleaning & care information'.

### **9) CAUTION SERVICING/REPAIR OF ELECTRONIC COMPONENTS**

- There are no user-serviceable components in the electric power seat lifting assembly. Servicing and repairs are only to be carried out by Leckey-authorized personnel.

### **10) CAUTION DISPOSAL**

- Only dispose of the seat in a community waste disposal site and ensure that the electrical components are removed for separate disposal.

### **11) CAUTION BRINGING INTO USE**

- When bringing the seat into use from storage, allow it to acclimatise to ambient temperature for 2 hours first. Wipe off any moisture that has condensed on the product.

## **SECTION 04: TERMS OF WARRANTY**

The warranty applies only when the product is used according to the specified conditions and for the intended purposes, following all manufacturer's recommendations (also see general terms of sale, delivery and payment). A three year warranty is provided on all Leckey manufactured products and components.

## **SECTION 05: PRODUCT HISTORY RECORD**

Your Leckey product is classified as a Class 1 Medical device and as such should only be prescribed, set up or reissued for use by a technically competent person who has been trained in the use of this product. Leckey recommend that a written record is maintained to provide details of all setups, reissue inspections and annual inspections of this product.

## **SECTION 06: PRODUCT TRAINING RECORD**

### **(PARENTS, TEACHERS & CARERS)**

Your Leckey product is a prescribed Class 1 Medical Device and as such Leckey recommend that parents, teachers and carers using the equipment should be made aware of the following sections of this user manual by a technically competent person:

#### **SECTION 07**

Safety Information

#### **SECTION 12**

Frequent Adjustments for Daily Use

#### **SECTION 13**

Cleaning and Care Information

#### **SECTION 14**

Daily Product Inspection

Leckey recommend that a written record is maintained of all those who have been trained in the correct use of this product.

## **SECTION 07: SAFETY INFORMATION**

1. Always read instructions fully before use.
2. To improve safety we recommend that users should not be left unattended at any time whilst using Leckey equipment.
3. Only use Leckey approved components with your product. Never modify the product in any way. Failure to follow instructions may put the user or carer at risk and will invalidate the warranty on the product.
4. If in any doubt to the continued safe use of your Leckey product or if any parts should fail, please cease using the product and contact our Customer Care Team or your local dealer as soon as possible.
5. Carry out all positional adjustments and ensure that they are securely fastened before you put the user into the product. Some adjustments may require the use of a tool which is provided with each product. Keep all tools out of reach of children.
6. When putting the user into a Seat, both for positional and safety reasons, always secure the pelvic harness first.
7. When the product is stationary ensure that all castors are locked and

- facing away from the base as this will improve product stability. This is especially important when the tilt in space or back recline facility is in use.
8. When the seat is in use on a Hi-Lo chassis please ensure that the height adjustment pedal and tilt in space lever are locked off and cannot be adjusted accidentally by other children.
  9. When the Leckey Seats are used on the Hi-Lo we do not recommend that users are moved over uneven surfaces when in the equipment. All due care and attention should be taken if transporting the user in and out of the seat.
  10. Never leave the product on a sloping surface, greater than 5 degrees. Always remember to lock all the castors.
  11. Only use the push handle to steer and move the seat from one area to another. Never use the tray or headrest for this purpose.
  12. The product contains components which could present a choking hazard to small children. Always check that locking knobs and bolts within the child's reach are tightened and secure at all times.
  13. Leckey products comply with fire safety regulations in accordance with EN12182. However the product contains plastic components and therefore should be kept away from all direct sources of heat including naked flames, cigarettes, electric and gas heaters.
  14. Do not place hot objects greater than 40°C on the tray.
  15. Clean the product regularly. Do not use abrasive cleaners. Carry out maintenance checks on a regular basis to ensure your product is in good working condition.
  16. The product is designed for indoor use and when not in use should be stored in a dry place that is not subjected to extremes of temperature. The safe operating temperature range of the product is +5 to +40 deg Celsius.
  17. Always check the plastic hand knobs on the push handle are tightened securely before you move the seat unit.
  18. Before using the Seat always check that the interface handle on the seat unit is fully engaged with the chassis. Make sure the locking pin is engaged so the handle cannot be accidentally released. If the handle is not engaged properly the seat unit may come loose and could cause serious injury to the child or carer.



## SQUIGGLES SEAT - CRASH TEST

The Leckey Squiggles Seat has been crash tested and passed for use in vehicles. It has been tested in its complete configuration on a surrogate base with a Leckey contoured head support attached.

If the Leckey Squiggles Seat is being used in a vehicle the following points must be adhered to:

The Squiggles Seat must be positioned forward facing and used with an Unwin Restraint System and a contoured head support which should be suitably positioned at all times during transportation. The contoured head support is available as an optional accessory with the Squiggles Seat.

The Squiggles Seat is crash tested and meets the requirements of ISO16840 part 4. For further details please contact our Customer Care Team.

### **Important**

These crash test details refer to the Leckey Squiggles Seat and interface plate only. If you are using the Squiggles Seat on a wheelchair base, please refer to the wheelchair manufacturer's handbook for crash test details.

## MEDICAL DEVICE COMBINATIONS

It may be possible to combine the Squiggles Seat with one or more other Medical Device or other product. Information on which combinations are possible can be found at [leckey.com](http://leckey.com). All combinations listed have been validated to meet the General Safety and Performance Requirements, section 14.1 of the Medical Device Regulation 2017/745.

Guidance on the combination, such as mounting, can be found at [leckey.com](http://leckey.com)

## SECTION 08: PRECAUTIONS AND CONTRAINDICATIONS

### Precautions

- Fixed spinal deformities such as scoliosis or kyphosis
- Severe muscle contractures
- Severe muscular or skeletal asymmetry including hip dislocation
- Progressive and muscle wasting conditions
- High risk or recent history of bone fractures
- High risk of pressure related injury or open sores
- Strong, uncontrolled movement patterns
- Poorly controlled seizure activity
- Children dependent on the use of percutaneous endoscopic gastrostomy
- Medical instability including compromised respiratory or cardiovascular function
- Dependant on 3rd party life-sustaining apparatus such as oxygen tanks
- Significant learning disabilities and/or behavioural issues

### Contraindications

There are no contraindications associated with the Leckey Seating product family.

All precautions and contraindications are taken at the discretion of the prescribing clinician. Leckey recommends a trained and experienced clinician to be present during the initial assessment, set up, configurations and re-issues in order to minimise risk.

## SECTION 09: HOW TO UNPACK AND ASSEMBLE THE SEAT

### Check parts

Congratulations on purchasing your Squiggles Seat. When opening the boxes, cut the straps, taking care not to cut through the tape as you may damage some of the parts contained inside. All of the parts will be contained in polythene bags with each one clearly labelled. Carefully remove them from the boxes and check you have all the parts you have ordered.



**Safety first**  
Keep polythene bags away  
from children.

Some of the accessories will need to be assembled before you attach the seat to the base you have purchased. If you are fitting the seat to a mobility base please ensure you fit the interface plate to the mobility base first. Instructions on how to attach the interface to specific bases will be provided with the interface plate. Once you have checked all the components you are then ready to assemble the Squiggles Seat and attach it to its base.

### Multi-tool

A number of adjustments will require the use of the multi-tool, which is supplied with each seat and can be found in the back pack.



## 9.1 LOCATING THE BACKREST

The backrest will be folded down for shipping. Raise it into the vertical position and, while doing so, slide the inner tube (A) into the receiving backrest pivot lock (B). Secure the backrest in an upright position by tightening the ratchet handle (C). Check that it is secure and does not move when pressure is applied.



## 9.2 ATTACHING THE SHOULDER SUPPORT

Attaching the shoulder support will increase the size of the Squiggles seat. Remove the headrest bracket. This is studlocked into position for safety reasons and will require force to break. Insert the shoulder support between the backrest and headrest bracket. Reattach the headrest bracket using the 2 sets of screws (A & B) provided.

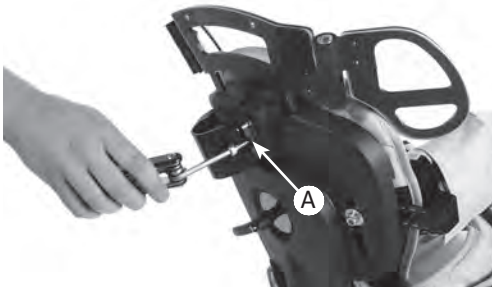
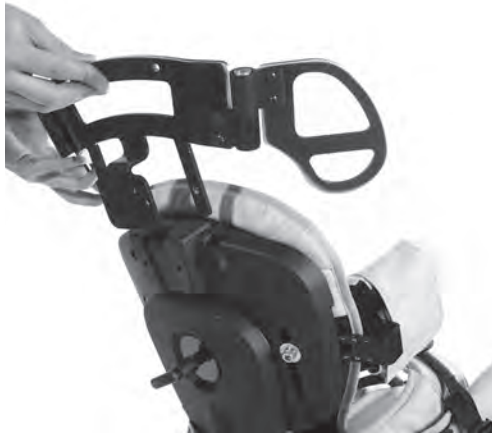
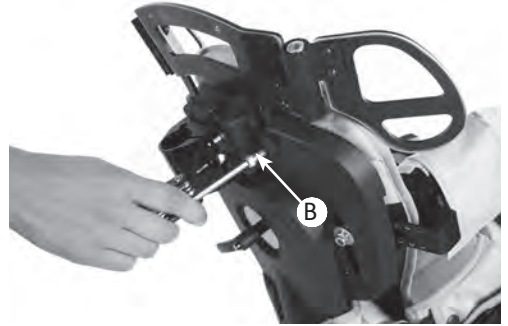

## 9.3 ATTACHING THE FOOTREST

To attach the footrest to the seat base, remove the bolt and nut from the metal stem on the footrest. Then slide the metal tube into the moulding as shown. When the hole in the metal plate is aligned with the hole in the moulding, replace the bolt and secure with the nut provided. Make sure the end of the bolt protrudes from the end of the nut. You can now attach the seat to your chassis and complete the assembly of the product and any accessories you have ordered.





Always make sure the foot plate is attached firmly.

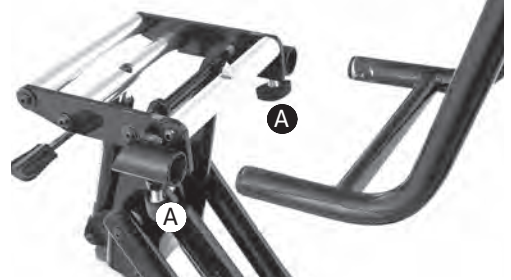

## 9.4 ATTACHING THE PUSH HANDLE

The push handle is attached to the Hi-Lo chassis by inserting the two lower stems into the receiving tubes as shown. The push handle has safety poppers, which need to be pressed in when inserting the lower stems. On the Hi-Lo chassis push the stems in until the poppers protrude from the other end of the receiving tubes.



 Check the knobs are tight before you move the product, particularly if you are moving the seat unit along corridors that may have uneven or sloping surfaces.

## 9.5 ATTACHING THE HEADREST

To attach the Lecky headrest slide the stem into the receiving bracket on the backrest, set to the desired position and secure using the plastic ratchet handle.

The Squiggles Seat has been designed to interface with Whitmyer head supports. The Whitmyer Lynx headsupport is attached in the same way as the Lecky headrest. To attach Whitmyer Pro-Series headsupports remove the spacer collar from the receiving bracket and lock the vertical stem in position using the ratchet handle.



Please note that the Headrest should never be used to push or steer the Seat, always use the push handle for this purpose.



## 9.6 ATTACHING THE RIGID LATERAL SUPPORTS/ PROTRACTION PADS

While holding the components together remove the bolt and washer. Align the plastic angle adjuster mouldings and lateral bracket with the slot in the backrest and refit the washer and bolt **A**.

Use the same method as above to attach the protraction pads.



## 9.7 ATTACHING THE POMMEL

To attach pommel, place the metal stem in the receiving channel **A**. To secure in place, push down firmly. There is a key slot to ensure the stem is located correctly. The metal tab on the stem should be facing the backrest when fitting the pommel. Insert the pin to prevent the pommel from being accidentally removed.



Always remove the pommel before placing the child in the seat.







## 9.8 INSERTING ATTACHMENT BOLTS ON SANDALS

Insert the required attachment bolt **A** along with the retention plate **B**. Place a rubber lid **C** on, both, the top and bottom of the sandal. Fasten using the four screws **D** provided. To remove or replace the attachment bolt, reverse this process.

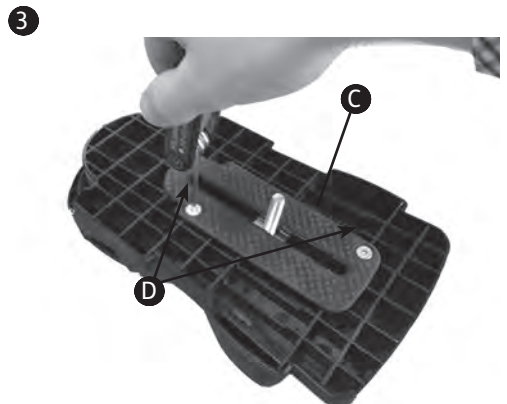
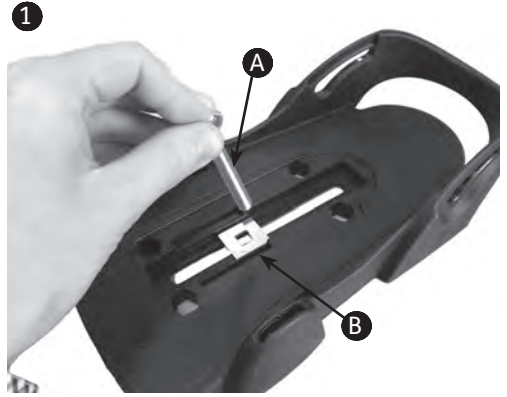

## 9.9 ATTACHING THE SANDALS

Place the sandal so that the attachment bolt goes through the slot in the footplate. To secure, on the underside of the footplate place the rubber washer **A**, followed by the metal washer **B** and then the knob **C** onto the attachment bolt. To position the sandals simply loosen the knob **C** under the footplate, select the position you require and re-fasten the knob.

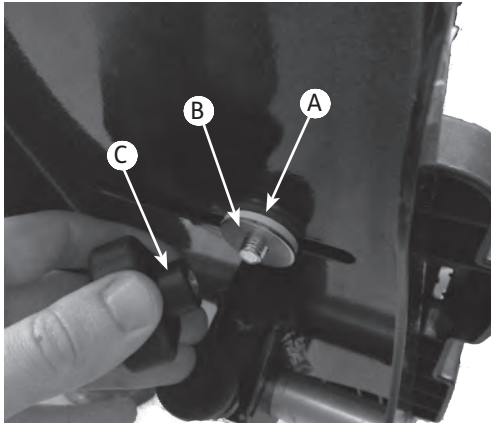

## 9.10 ATTACHING THE ANKLE HUGGERS

Slide the webbing through the slot in the sandal. Loop the webbing back up and through the bottom of the triglide. Then pass the webbing through the top of the triglide. Finally to lock the webbing in place, pass it through the bottom of the triglide again. Trim strap to required length.







## 9.12 ATTACHING THE TRAY

The tray is attached to the seat by inserting the tubes into the receiving brackets. Once the tray is located in position the ratchet handle **A** should be tightened securely.

## 9.11 ASSEMBLE THE TRAY

To attach the arms to the tray brackets, loosen the ratchet handle **A**, place the mouldings to the inside of the tray plate so the plastic teeth mesh. Replace the ratchet handle on the outside. Repeat on other side. Ensure both horizontal tubes are aligned so they locate in the tray bracket receivers.



## 9.13 ATTACHING THE GRAB RAIL

To attach the grab rail, insert the receiving brackets **A** in the tray slot and secure with the plastic knob **B**. Repeat on the other side and then slide the tubes into the receiving brackets **A** and tighten the plastic knob **A**.

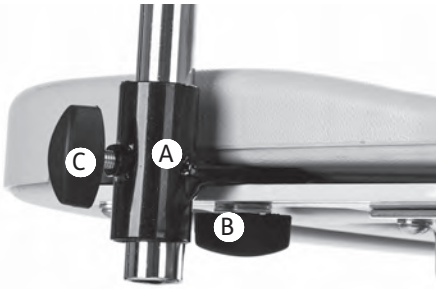

## 9.14 ATTACHING THE LONG SITTING SUPPORT

First attach the receiving brackets **A** to the underside of the seat base. There is an aluminium plate with pre-drilled holes onto which they are attached. Open the receiving brackets **A** under the seat base using the hand knobs **B**. Insert the long sitting support bars. Adjust to the required depth and retighten the knobs.

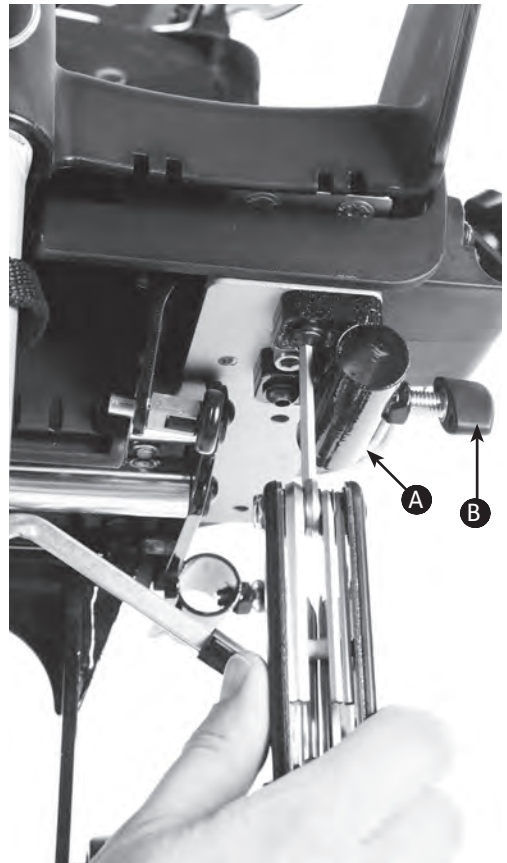

## 9.15 INTERFACES FOR WHEELCHAIR AND PUSHCHAIR BASES

The set up and attachment of the Squiggles seat to any mobility base should be completed by a technically competent person who is familiar with the set up of the mobility base.

Interface “A” attachment to 12” wide mobility base The universal interface has been designed to enable the Squiggles Seat to be attached to any standard 12” (305mm) wide mobility base that has been constructed from 1” (25.4mm) side tubing.

Please refer to specific assembly instructions supplied with your interface for correct positioning on your base.

The Interface plate should be fitted by a qualified technician who is technically competent in the set up of the mobility

base. The position of push handles, leg hangers and armrests on the mobility base may need to be adjusted depending on the size and weight of the child to ensure the stability of the seat.



Always refer to the mobility base manufactures guidelines for correct set up, paying particular attention to product centre of gravity and stability.

Users should not be left unattended at any time whilst using Leckey equipment.



## SECTION 10: FITTING THE CUSHIONS

It is advisable to fit the cushions in the following order:

1. Femoral guides
2. Seat base
3. Sacral support
4. Pelvic belt
5. Backrest
6. Laterals
7. Shoulder support (if applicable)
8. Chest harness
9. Head rest

### 10.1 FEMORAL CUSHION

It is easier to fit the femoral cushion if you first slide the femoral guide forward. (See section 11 on how to adjust seat depth)

Slide the femoral cushion over the femoral guides. The femoral cushion goes under the one piece seat base cushion.



### 10.2 ONE PIECE SEAT CUSHION

It is easier if you angle the back rest forward before fitting the seat base cushion (see section 11). Align the one piece seat cushion on the seat base with the leg sections facing forward. Secure at the back of the cushion with the two snap fasteners **A** and then at the sides **B**. The cushion is then secured at the front by hooking the two elastic tabs **C** onto the hooks **D** under the seat.





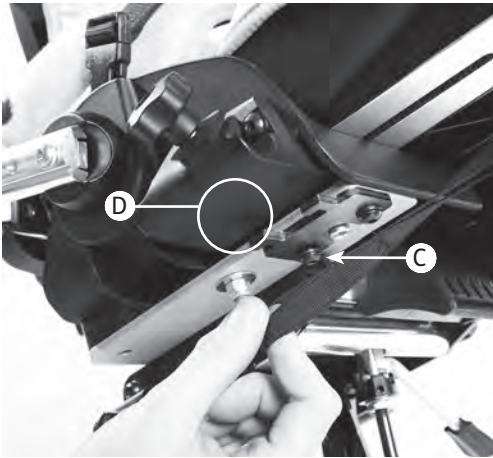
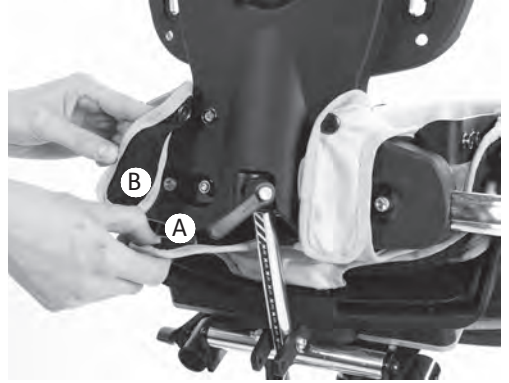

### 10.3 SACRAL CUSHION

Align the sacral cushion with the lower backrest and press down to locate the snap fasteners. Bring the lower tabs **A** under the backrest and attach to the Velcro on the upper tabs **B**.

### 10.4 PELVIC HARNESS

The Pelvic Harness is attached by sliding the hip guides into the pockets **A** on the outerface of the harness. It is attached in the desired position by securing it to one of the snap fasteners **B** on the adjustable hip guide bracket. The buckle on the tie down strap is clipped into a receiving buckle **C** on either side of the seat base. Finally secure the pelvic harness by attaching the centre plastic buckle **D**.

## 10.5 BACKREST CUSHION

If you have lateral supports fitted to your chair, adjust them to their maximum width before attaching the backrest cushion. Secure the cushion in place using the four snap fasteners in the backrest moulding. Align the top fasteners **A** first and snap in place, then secure the lower fasteners. There is a velcro panel provided in the lower part of the cushion to accommodate positional wedges/pads.

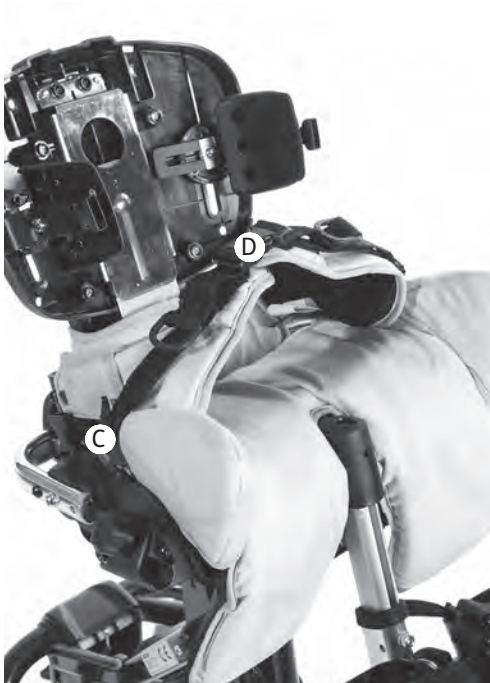
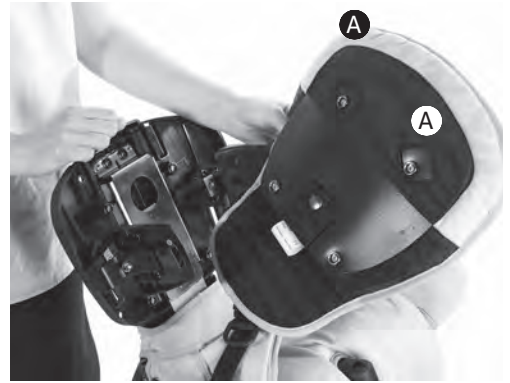
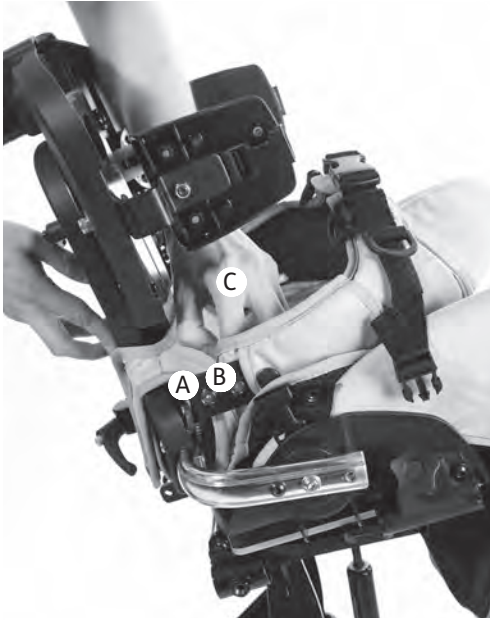

## 10.6 LATERAL SUPPORT PADDED CUSHIONS

To attach the lateral support padded cushions, simply slide the cushions on, with the padded side towards the inside of the seat. Thread the plastic buckle **A** through the slot in the cover, then bring the two velcro fastener straps around the bottom of the moulding and attach them to the velcro panel as shown. Close over the flap **B**.



## 10.8 CHEST HARNESS

The chest harness can be attached by clipping the male buckle (A) into the female buckle at either side of the lateral supports.

## 10.7 SHOULDER SUPPORT CUSHION (IF APPLICABLE)

If you have a shoulder support section, slide the cushion over the assembly and secure using snap fasteners. It is easier if you loosen the shoulder support laterals first (see section 11).



## 10.9 CONTOURED HEADREST CUSHION

To attach the headrest cushion, place the cushion onto the head support plate, then snap the side and upper fasteners in place. Bring the lower flap under the plate and snap the two remaining fasteners in place.

The plastic reinforcement piece should be placed between the headrest assembly and the cushion, but should not be zipped inside the cushion.

## 10.10 FLAT HEADREST CUSHION AND LATERAL COVERS

To attach the flat headrest cushion, place the cushion onto the head support plate, then snap the central and upper fasteners in place. The headrest lateral covers are attached in the same way as the lateral support padded covers.





---

## SECTION 11: CLINICAL SETUP FOR POSTURAL MANAGEMENT

The clinical setup of the product should be completed by a technically and clinically competent person who has been trained in the use of the product. Leckey recommend a written record is maintained of all clinical setups for this product.

Set the back height, seat depth and footplate height before placing the child in the seat. These can be fine tuned when the child is in the seat.

---

### 11.1 PELVIC HARNESS AND HIP GUIDES

To set the width of the hip guides loosen the screws **A**, adjust to the desired width and retighten. To adjust the depth of the harness, move the snap fastener **B** to either position. Adjust the support straps **C** to the required length. Ensure the buckle **D** connects securely in the middle. If using the seat outdoors and your child is wearing a coat, position the pelvic harness under the coat.



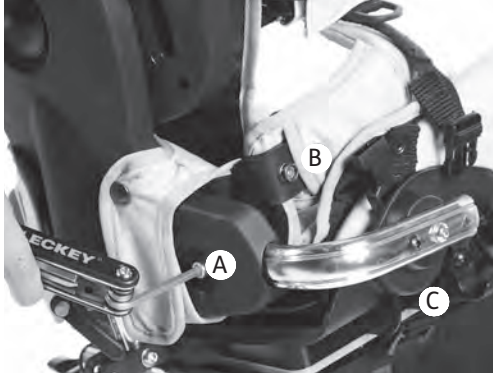

## 11.2 PELVIC HARNESS SPACER PADS

The pelvic harness spacer pads can be used to reduce the width between the hip guides. To attach simply place spacer pads on the inside of the harness and secure with Velcro flaps on the outside as shown.



## 11.3 SEAT DEPTH

To adjust the seat depth simply loosen the bolts **A**, on the underside of the seat and adjust to the depth required. Retighten the bolts securely. The position can be fine tuned with the child in the seat.

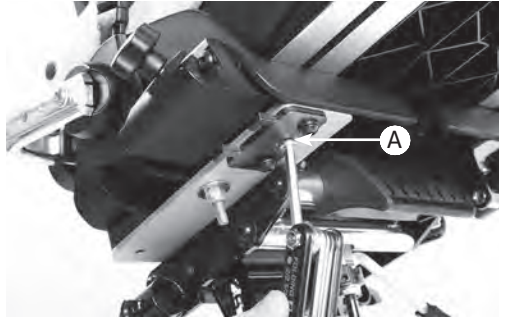

## 11.4 BACKREST HEIGHT

The overall height of the backrest can be adjusted by loosening the ratchet handle **A**, then positioning to the required shoulder height of the user. Once in position the ratchet handle should be retightened securely. The position can be fine tuned with the child in the seat.

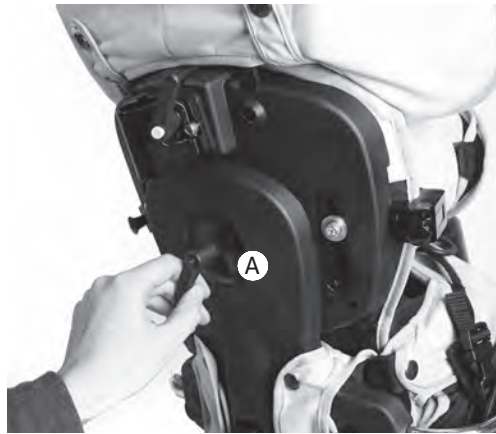

## 11.5 BACKREST ANGLE

The backrest can be angled by loosening the ratchet handle (A) on the backrest pivot lock, setting to the required angle and retightening the ratchet handle securely. Use the scale on the side of the tube to help select required angle.



Always ensure the back angle is secure to maintain the desired posture for the child. The back angle can be adjusted with the child in the seat.

## 11.6 FOOTPLATE HEIGHT

To set the height of the footplate loosen the screw **A** on the front of the calf support tube, and slide the footplate to the required height and retighten the screw.

To set the correct height of the footplate measure the distance from the back of the child's knee to the bottom of their heel. This can be set with the child in the seat.



Always ensure the footplate is secure before placing the child in the seat to prevent them from sliding down in the seat.



## 11.7 SACRAL PAD AND LUMBAR SUPPORT

There is a velcro panel provided in the lower part of the backrest cushion and on the sacral cushion to accommodate positional wedges/pads **A**. These simple “C” shaped wedges are a very simple but effective means of providing sacral or lumbar support depending on the child’s needs.



## 11.8 LATERAL SUPPORTS/ PROTRACTION PADS

Loosen the screw **A** to adjust the width, height and angle of the lateral supports and retighten when you have selected the desired position.

Use the same method to adjust the height and angle of the protraction pads.



## 11.9 SHOULDER SUPPORT LATERALS

To change the angle of the shoulder support laterals, loosen the screws **A**, adjust to the required angle and retighten.

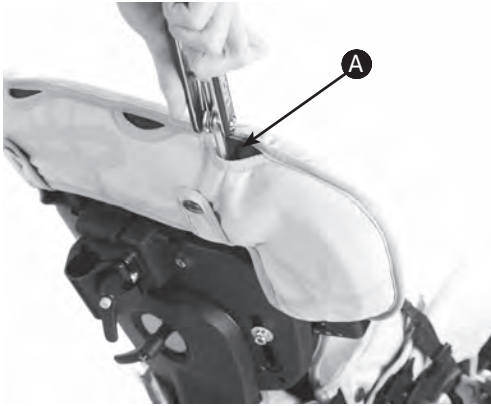

## 11.11 FOOTPLATE ANGLE ADJUSTMENT

To set the angle to accommodate plantarflexion or dorsiflexion, simply loosen or tighten the hand knob **A** to select the angle you require.



## 11.10 CHEST HARNESS

To change the width of the chest harness, lift the front cover, adjust the velcro straps **A** to the desired width and replace the cover.



## 11.12 SANDALS

To position the user's feet in the sandals, secure the Velcro straps provided so the foot is held in place. The straps should be placed over the bridge of the foot and over the toes. The front strap can be fed through one of two slots on either side of the sandals, depending on the size of the user's feet **2**.

If the child is wearing sandals or light footwear check the straps to make sure the webbing does not irritate the skin.



1



2



## 11.13 CONTOURED HEADSUPPORT

To adjust the height, depth and angle of the contoured headrest, loosen the hand knobs **A** and when set to the desired position retighten the knobs.



Always use caution to ensure fingers do not become trapped in the slot when height adjusting the headrest.

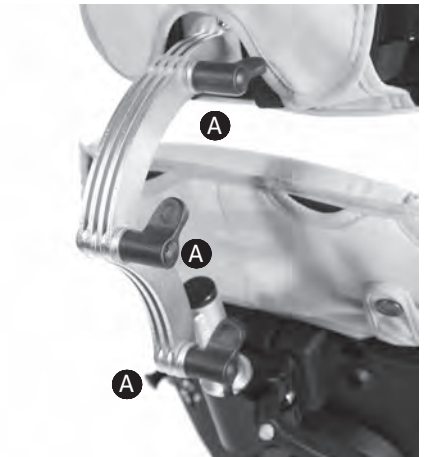

## 11.14 FLAT HEADREST WITH LATERAL SUPPORTS

To adjust the height, depth and angle of the flat headrest, adjust using the hand levers **A**.

To adjust the width of the laterals loosen the plastic knob **B**, slide to desired position and tighten securely.

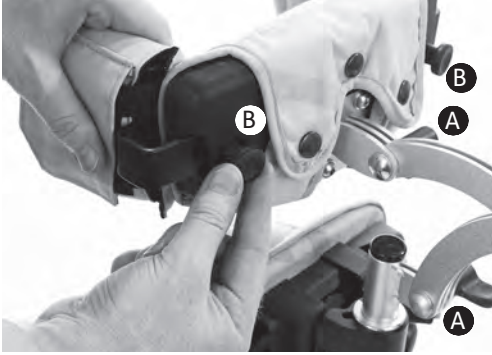

## 11.15 TRAY ADJUSTMENT

To adjust the depth of the tray, loosen knob **A** set to the required position then retighten securely. To height adjust the tray, loosen knob **B**, set to the required position and then retighten securely. To angle adjust the tray, loosen ratchet handle **C**, set to the required angle and then retighten securely.



Do not adjust the horizontal bars beyond the moulding, except when you are removing the tray.

Always use caution to ensure the child's hands or arms do not become trapped when inserting the tray.

Never use the tray to steer or push the chair.

Always use caution to ensure that fingers do not become trapped in the slot when height adjusting the armrest.



Do not place hot objects, greater than 40 degrees Celsius, on the tray.

Please note that the tray is for the use of the user only. Do not lean or place heavy objects on the tray greater than 8kgs (17.6lbs).



## 11.16 GRAB RAIL ADJUSTMENT

To set the height, loosen knob **D**, adjust to required position and retighten securely.

To set the depth of the grab rail to suit the child's reach, loosen knob **E** adjust to the required depth and then retighten.



## SECTION 12: FREQUENT ADJUSTMENT FOR DAILY USE

[THERAPISTS/CARERS/PARENTS]

Parents and carers should be shown how to make frequent adjustments and made aware of the safety checks in Section 7 by a technically and clinically competent person who has been trained in the use of the product. Leckey recommend that a written record is maintained of all parent and carers who have been trained in the use of this product.





## 12.1 TRANSFERRING YOUR CHILD INTO AND OUT OF THE SEAT

Before transferring the child into the seat carry out the daily product inspection as outlined in section 14 of this user manual.

Adjust the seat to a comfortable height to facilitate transfer. Lock all the castors **A** ensuring that they are facing outwards to maximise product stability. Make sure the safety buckle on the chest harness is released **B** and is out of the way to facilitate transfer. Remove theommel **C**.

Unclip the pelvic harness in the middle **D** and allow the harness to open out to facilitate transfer. Lastly if sandals **E** are fitted open the straps. You are now ready to transfer or hoist the child into the seat.

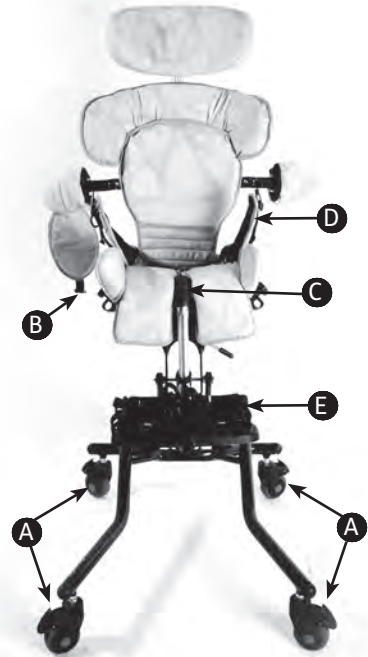

## 12.2 ADJUSTING THE PELVIC HARNESS

The correct positioning and tensioning of the pelvic harness is key to a child's postural management affecting their comfort and ability to achieve functional goals. Please ask your therapist as to the correct tensioning of straps for your child as this is critical to good postural management.

To tension the pelvic straps and pads around the child pull the centre strap **A**. Pull the two side straps **B** up to fine tune the pelvic position and adjust the height of the pads on the hips.



Always secure the pelvic harness first before fastening other buckles or harnesses. Adjust the harness so the child cannot slide or creep forward in the seat.



Check the harness regularly to ensure the child is safe and cannot slide forward in the seat.



Always keep the locking pin engaged when you are not adjusting the chassis. This will prevent the foot pedal being operated accidentally.

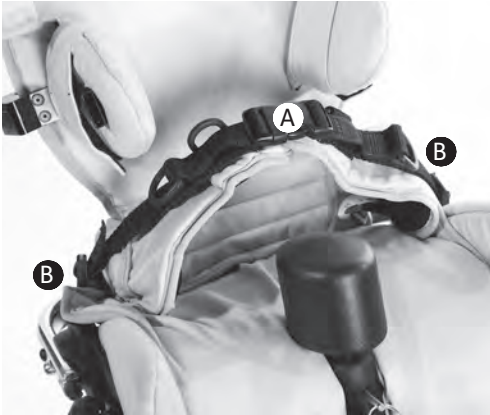

## 12.3 HEIGHT ADJUSTMENT – HI-LO CHASSIS

You can carry out this adjustment with the child in the chair. To adjust the height of the Hi-Lo chassis press the foot lever **A** at the rear of the chassis whilst holding the push handle **B**. Once you remove your foot from the pedal the seat will be fixed at the chosen height.

For safety the height adjustment pedal on the chassis can be locked by engaging the pull pin **C** on the right hand side of the pedal. To unlock pull the pin out and rotate 90 degrees. The pedal can then be operated. The locking pin **C** should be kept in the locked position when you are not adjusting the chassis.

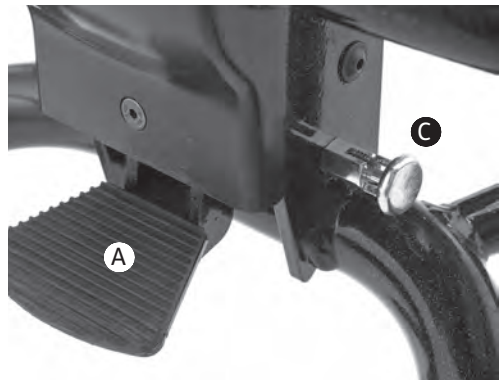

## 12.4 TILT IN SPACE

The tilt in space can be angled while the user is in the seat. Before you adjust the tilt in space angle of the seat always ensure the pelvic harness is secured, preventing the user from sliding forward in the seat.

To adjust the tilt angle press the lever under the seat base. Once you have selected the angle you require, by simply removing your hand from the lever, the chair will be locked in position. The tilt-in-space should be locked off while the user is in the seat.

To lock the lever twist the pull pin to the right hand side of the lever and the pin will pop into position. You may have to lift the lever slightly to allow it to lock. To unlock pull the pin out and rotate 90 degrees, the lever can then be operated.



Always keep the tilt-in-space lever in the locked position to prevent accidental actuation

of the lever which could cause the seat unit to jolt and possibly cause injury to the child.

Please use handle bars when operating tilt in space.

Always check with your therapist that the use of tilt in space will not cause any obstructions to the child's airways.

## 12.5 CHEST HARNESS ADJUSTMENT

If the child requires chest support as part of their postural support programme the seat will be fitted with rigid laterals or a combination of laterals and chest harness. These may need to be adjusted on a daily basis to accommodate differences in clothing.

Always check with your therapist as to the optimum positioning and tensioning of the straps and support items for the child.

To change the width of the chest harness, lift the front cover, adjust the Velcro straps **A** and set to the desired width. When the correct width has been achieved replace the cover.



Always make sure the plastic buckles are fully engaged when using the chest harness.

Check the harness and laterals are secure to ensure the child is safe and cannot slide forward in the seat as this may restrict their breathing.



## 12.6 SANDALS

To position the user's feet in the sandals secure the Velcro straps provided so the foot is held in place. The straps should be placed over the bridge of the foot and over the toes. The front strap can be fed through one of two slots on either side of the sandals, depending on the size of the user's feet 2.



If the child is wearing sandals or light footwear check the straps to make sure the webbing does not irritate the skin.

## 12.7 TRAY ADJUSTMENT

The activity tray can be used for a range of functions and its position can be fine tuned to suit the user and the activity whether it is for fun, education or feeding. The tray is attached to the seat by inserting the tubes into the receiving brackets. Once the tray is located in position the knob **A** should be tightened securely.

To height adjust the tray loosen knob **B** set to the required position and then retighten securely. To angle adjust the tray, loosen knob **C**, set to the required angle and then retighten securely.



Always use caution to ensure the child's hands or arms do not become trapped when inserting the tray.

Never use the tray to steer or push the chair.



Always use caution to ensure fingers do not become trapped in the slot when height adjusting the tray.

Do not place hot objects, greater than 40 degrees Celsius, on the tray.

Always make sure the plastic buckles are fully engaged when using the chest harness.

Please note that the tray is for the use of the user only. Do not lean or place heavy objects on the tray greater than 8kgs (17.6lbs).

## SECTION 13: CLEANING & CARE INFORMATION

### How to Maintain

When cleaning we recommend that you use only warm water and a non-abrasive detergent. Never use organic solvents or dry cleaning fluids.

### Upholstery and fabrics

1. The upholstery and fabrics can be removed and machine washed at 40°C and tumble dried on a low setting.

Please remove the foam from the following covers before washing:

- Headrest
- Shoulder support
- Backrest cushion
- Seat base cushion

All other soft upholstery can be placed into the washing machine intact, after removing bolts and fastenings.



2. They can also be cleaned by hand whilst in place. When cleaning we recommend that you use only warm water and a non-abrasive detergent. Microfibre cloth is good for cleaning the fabric.
3. Staining should be removed as quickly as possible with absorbent cloth, towels or a sponge. Routine soap and warm water sponging is effective for ordinary soiling and minor spills. Be careful not to over wet the fabric as this will cause the staining to spread.



4. Antiseptic cleaning agents can be used on more stubborn stains. These may require a safe solvent such as Isopropyl Alcohol or Mineral Spirit. A half cup of household bleach to 5 litres of water can also be used as a useful disinfectant.
5. The pelvic and trunk harnesses can be machine washed at 40 Deg C. Make sure all bolts and fasteners are removed first as they may cause damage to your washing machine. Store these in a safe place and out of reach from children.
6. Always ensure the product is dry before use.

### **Metal and plastic components**

7. Soap and water or antibacterial spray can be used for daily cleaning.
8. For deep cleaning a low pressure steam cleaner can be used.
9. Do not use solvents to clean plastic or metal components.
10. Make sure the product is dry before use.

## SECTION 14: DAILY PRODUCT INSPECTION

### (Therapists, parents & carers)

We recommend that daily visual checks of the equipment are carried out by therapists, carers or parents to ensure the product is safe for use. The recommended daily checks are detailed below.

1. Ensure all adjustment handles, knobs and bolts are in place and secure.
2. Check all upholstery and velcro for signs of wear and tear.
3. Check all castors are moving freely and lock securely.
4. Ensure the handle and locking pin on the seat interface plate are fully engaged and the seat unit is securely fixed onto the chassis.
5. Ensure the pelvic harness is fully secured around the user and they cannot slide or creep forward in the seat.
6. Ensure the footplate is attached securely.



If in any doubt to the continued safe use of your Lecky product or if any parts should fail, please cease using the product and contact our Customer Care Team or your local dealer as soon as possible.



## SECTION 15: ANNUAL PRODUCT INSPECTION

**(Therapist, Technician, Leckey Product Specialist, Dealer)**

Leckey recommend that each product should be subject to a detailed inspection at least once a year and every time the product is reissued for use. This inspection should be carried out by a technically competent person who has been trained in the use of the product and should include the following checks as a minimum requirement.

1. Check all ratchet handles, knobs, nuts, bolts and plastic buckles are in place, replacing any missing items. Pay particular attention to the following items;
  - Headsupport locking bolts.
  - Backrest height and angle adjustments bolts.
  - Seat depth adjustment bolts.
  - Pelvic harness / hip guide attachment bolts.
  - Footrest height and angle adjustment.
2. Check the chassis height adjustment mechanism is working properly. If the chassis is foot pedal operated ensure the seat height doesn't change when the pedal is released.



If in any doubt to the continued safe use of your Leckey product or if any parts should fail, please cease using the product and contact our Customer Care Team or your local dealer as soon as possible.

Also, check that the locking pin engages securely to prevent accidental height adjustment of the chassis.

3. Adjust the seat to its maximum range of tilt in space and ensure that the locking lever locks the seat out securely at varying point in this range.
4. Check that where the seat and chassis join there is no visible wear or tear on the metal components.
5. Lift the base to check each castor individually. Make sure they are moving freely and remove any dirt from the rubber wheels. Check that the brakes lock the wheels securely.
6. Visually check the structure of the product paying attention to weld points on the frame ensuring there are no signs of fatigue or cracking around the welds.
7. Leckey recommend that a written record is maintained of all annual product inspections.

## SECTION 16: RE-ISSUING LECKEY PRODUCTS

Most Leckey products are assessed and ordered to meet the needs of an individual user. Before reissuing a product we recommend that the therapist prescribing the product has carried out an equipment compatibility check for the new user and has ensured that the product being re-issued contains no modifications or special attachments.

A detailed technical inspection should be carried out on the product prior to re-issuing. This should be carried out by a technically competent person who has been trained in the use and inspection of the product. Please refer to **section 15** for the required checks to be carried out.

Before re-issuing a product, we recommend it is disinfected using the following procedure:

**Note: Always clean the product first to remove accumulated soiling prior to disinfecting/sanitising**

1. Where possible, we recommend the use of an automated “fogger” disinfection system that is used to completely cover the product surfaces with a disinfectant agent. The manufacturer’s instructions for the chosen system should be referred to prior to use and followed exactly.
2. Where an automated disinfection system is not available, all product surfaces should be wiped over with disinfectant surface wipes or liquid disinfectant on a soft cloth. Suitable products are 70% IPA, 70% Alcohol or diluted bleach. The manufacturer’s instructions for the chosen product should be followed. Product upholstery and fabrics should be cleaned thoroughly in accordance with section, Cleaning and Care Information, of this manual.

Ensure a copy of the user manual is supplied with the product. A copy can be downloaded from our website **[www.leckey.com](http://www.leckey.com)**

Leckey recommend that a written record is maintained of all product inspections carried out during the reissue of the product.

## **SECTION 17: PRODUCT SERVICING**

Servicing of all Leckey products should only be carried out by technically competent persons who have been trained in the use of the product.

All international service enquiries should be directed to the appropriate Leckey distributor who will be delighted to assist you. For further information on Leckey distributors please visit our website **[www.leckey.com](http://www.leckey.com)**

## SECTION 18: TECHNICAL INFORMATION

### Squiggles seat dimensions

<b>Ages (approx)</b>	1 - 5
<b>Max User Weight</b>	22kg / 48.4lbs
<b>User Height</b>	Min 750mm / 29.5 inches Max 1100mm / 43.3 inches
<b>Seat Width</b> [Distance between hip guides]	Min 160mm / 6.25 inches Max 260mm / 10.2 inches
<b>Seat Depth</b> [Back support to back of knee]	Min 190mm / 7.5 inches Max 290mm / 11.4 inches
<b>Knee Width</b> [Distance between pommel and side of seat]	Max 90mm / 3.5 inches
<b>Footplate</b>	Plantarflexion 10° Dorsiflexion 10°
<b>Chest Width</b> [Distance between laterals]	Min 160mm / 6.25 inches Max 220mm / 8.75 inches
<b>Hi-Lo Chassis</b> [Minimum dimensions for storage]	Weight 9kg / 19.8lbs Width 540mm / 21.13 inches Length 640mm / 25.2 inches Height 315mm / 12.4 inchesW
<b>Seat Weight</b>	6kg / 19.8lbs
<b>Seat Width</b>	524mm / 21.3 inches











Continued









## Squiggles seat dimensions

<b>Backrest Height</b> (Sitting shoulder height)	Min 320mm / 12.6 inches Max 380mm / 15 inches
<b>Backrest Angle</b>	Prone 10° Recline 25°
<b>Seat to Footplate</b> (Sole of foot to back of knee)	Min 122.5mm / 4.8 inches Max 270mm / 10.6 inches
<b>Tilt in space - Hi-Lo Chassis</b>	Prone 10° Recline 30°
<b>Top of Seat to Floor</b> (Hi-Lo chassis)	Min 270mm / 10 inches Max 650 mm / 25 inches
<b>Tray Height</b> (Seat to top of tray)	Min 115mm / 4.5 inches Max 170mm / 6.7 inches
<b>Tray Size</b>	460mm x 560mm 18.1 inches x 22 inches
<b>Product stability guidelines</b>	Forward 5 degrees Backwards 10 degrees Sideways 5 degrees

## TABLE OF SYMBOLS

Symbol	Meaning
	Medical Device
	Read the Instructions for Use
	CE mark
	UKCA mark
	Warning
	Manufacturer
	Serial number
	Product code
	Max occupancy weight
	Date of Manufacture
	Latex free



Symbol	Meaning
 The symbol consists of the letters "UDI" in a bold, sans-serif font, enclosed within a rectangular border.	Unique Device Identification
 A stylized icon of a person sitting in a car seat, with a vertical line through the seat, indicating a crash test.	Crash tested
 A symbol of a washing machine tub with the number "40" and a degree symbol inside, indicating a machine wash temperature of 40°C.	Machine wash- water temperature 40°C
 A symbol of a square with a circle inside, and a smaller circle in the center of the square, representing a tumble dry low heat setting.	Tumble dry- low heat
 A symbol of an iron with a diagonal line through it, indicating that the item should not be ironed.	Do not iron
 A symbol of a triangle with a diagonal line through it, indicating that the item should not be bleached.	Do not bleach

Leckey Seats can also interface on to a range of Sunrise Medical Mobility Bases. Please see table below for more information.

Squiggles Seat
ZIPPIE Iris
ZIPPIE TS

Please note crash tested combinations below:

The below table indicates the combinations that have been crash tested together, and those that have been tested as a seat and base separately. All listed combinations are commercially available in the market.

Unit	Base	Interface	Sales Code	Crash Tested? (Y/N)
SQUIGGLES SEAT	Sunrise Medical ZIPPIE Iris	Squiggles J	194-600	Y
SQUIGGLES SEAT	Sunrise Medical ZIPPIE TS	Squiggles J	194-600	Y

The Squiggles Seat can also be used with the Patron bases listed below. No interface required.

Product	Number
Chassis TOM5-CSI (MedDev.CZ.Reg.No.00602095) Version: T5SWKPYL	T5SWKPYL
Chassis TOM5-CSI (MedDev.CZ.Reg.No.00602095) Version: T5SWKPS2L	T5SWKPS2L









**USA Distributor**

Sunrise Medical [US] LLC  
2842 N Business Park Avenue  
Fresno, CA 93727

**T:** 1-800-333-4000  
**F:** 1-800-300-7502  
**E:** [customseating@sunmed.com](mailto:customseating@sunmed.com)

[sunrisemedical.com](http://sunrisemedical.com)

**Canadian Distributor**

Sunrise Medical  
237 Romina Drive, Unit 3,  
Concord, ON, L4K 4V3

**T:** +1.800.263.3390  
**F:** +1.800.561.5834  
**E:** [mkt.canada@sunmed.com](mailto:mkt.canada@sunmed.com)

[sunrisemedical.ca](http://sunrisemedical.ca)

Please visit [leckey.com](http://leckey.com) for a full list of Leckey distributors.

**UK  
CA**

James Leckey Design Limited  
19 Ballinderry Road  
Lisburn, BT28 2SA  
Northern Ireland

[leckey.com](http://leckey.com)

**(+44) 28 9260 0750**  
**[hello@leckey.com](mailto:hello@leckey.com)**

