



SUNDIAL

MAGAZINE

Naidex Edition
March 2024

The Future Of Power Assists

Get a peak at all the
new products from
our Empluse brand

Naidex Special

Packed full
of exclusive
offers & deals

WIN YOUR DREAM CHAIR

See inside for how you can
WIN the Q55 X manual
chair of your dreams

Less To Lift. More To Love.

An in-depth look at QUIKCIE's lightest
folding powerchair, the Q50 R Carbon



WIN YOUR DREAM CHAIR

Create your dream QS5 X folding manual wheelchair using our online visualiser, upload it to Facebook and tag QUICKIE Wheelchairs UK for a chance to win!

Post with the highest numbers of likes wins. Sharing & tagging your friends may help you reach higher number of likes. Giveaway ends 31st March 2024.

T&Cs apply.

Scan the QR code
with your phone's
camera to access
the visualiser.





Welcome

Sunrise Medical is thrilled to return to Naidex in 2024 with a special edition of Sundial Magazine. This exclusive publication brings you a curated collection of captivating articles, insightful product features, and an array of Naidex exclusive offers you won't want to miss.

Discover the **Future of Power Assists** with the latest product releases from Empulse, offering a glimpse into cutting-edge mobility solutions. Dive deep into the world of manual wheelchairs with an in-depth look at QUICKIE's newest folding model, the **QS5 X**. Additionally, explore the innovative design of QUICKIE's lightest ever folding powerchair, the **Q50 R Carbon**, promising unparalleled convenience and mobility.

Join us as we embark on an exciting journey through the diverse and innovative offerings from Sunrise Medical at Naidex. Don't miss out on this opportunity to explore the future of mobility and take advantage of **exclusive offers** available only at Naidex.



In This Issue

- 4 The Future of Power Assists With Empulse
- 6 StreetJet - Easy Riding. Effortless Docking.
- 8 Introducing The QS5 X - Unfold Your Freedom
- 10 The QUICKIE Nitrum
- 12 Q50 R Carbon - Less To Lift. More To Love.
- 15 Q700 M Series - Elevate Your Mobility Experience
- 16 Magic Mobility: Master Any Terrain, No Matter The Weather
- 18 Which Power Function Is Right for You?



The Future of Power Assists With Empulse

Sunrise Medical Unveils the latest products from their Empulse power assist range at Naidex 2024

Sunrise Medical is proud to return to Naidex in 2024, marking a significant milestone with the introduction of the Future of Power Assists by Empulse. This unveiling represents a pivotal moment in the industry, as we prepare to revolutionise the e-mobility landscape with our upcoming product lines, scheduled for release between 2024 and 2025.

At the heart of the Empulse brand lies a steadfast commitment to providing cutting-edge power assist solutions, deeply inspired by the diverse aspirations of our customers. Whether you're 18 or 81, and whether you seek powered bikes, powered wheels, or push devices, Empulse empowers individuals to pursue their passions and embrace life to the fullest.

Naidex 2024 serves as the premier platform for the unveiling of three groundbreaking new products, which will expand the Empulse product line with innovative solutions not currently available in the market:

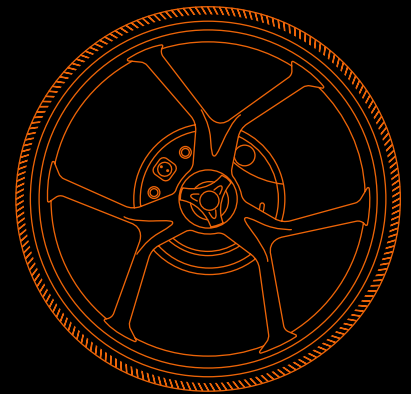
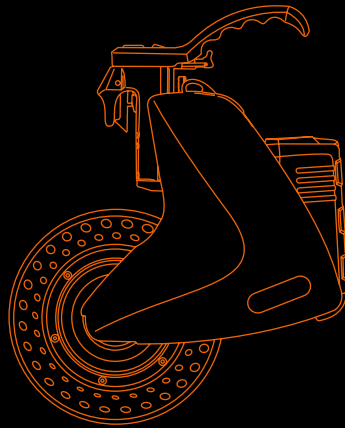
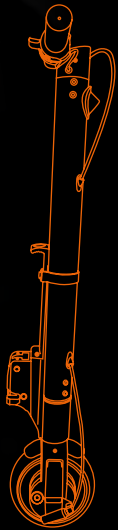

Empulse F35:

The Empulse F35 stands out as an ultralightweight transportable power assist that doesn't compromise on performance. Its slimline design and super lightweight construction make it ideal for users seeking a bike solution that seamlessly integrates into their lifestyle. Whether for daily commuting or holiday travel, the F35's compact design effortlessly fits into users' daily routines, offering a new level of convenience and accessibility to mobility.

Empulse R90:

The Empulse R90 offers intuitive operation and extended range compared to other products on the market. Featuring easily removable "power tool" style batteries and a freewheel mode, users can double their range and choose when to engage the device without removing it from their chair. With centred manoeuvrability and easy docking, the R90 ensures users maintain their independence while navigating tight spaces and diverse environments.

Empulse M90:

The Empulse M90 embodies the essence of modern mobility with its sleek design and advanced features. Weighing only 6kg per wheel, the M90 offers unmatched portability and ease of use. Its punchy performance, including speeds of up to 15kph and customisable drive controls, allows users to tailor their experience to their confidence level and environment.

"We recognise the varied needs of wheelchair users, which is why we have designed the Empulse series to be adaptable to a wide range of wheelchair makes and models," emphasised Simon Collins, Commercial Director at Sunrise Medical. "Whether navigating urban landscapes or exploring the outdoors, the Empulse series empowers users to venture wherever their hearts desire."

Empower your mobility with Empulse R90, F35, and M90 - Wherever Life Takes You.

For more information about the Empulse series and to explore Sunrise Medical's complete range of mobility solutions, please visit [sunrisemedical.co.uk](https://www.sunrisemedical.co.uk).



RRP: £3,995
Available to order now

Easy Riding. Effortless Docking.

StreetJet, the latest pull device from Empluse

Did you know that pushing your wheelchair for extended distances can exert significant strain on your muscles and joints? StreetJet offers a revolutionary solution, granting you the freedom to travel farther, faster, and for longer periods without the need for manual pushing!

Featuring a state-of-the-art electric system, StreetJet is a pull device designed for seamless integration with your wheelchair. Its patented one-touch clamp system ensures effortless connection, requiring minimal force – making it accessible even for those with limited hand function.

Experience unparalleled freedom with StreetJet's impressive capabilities, boasting an impressive range of up to 50 km and adeptness at navigating rough terrain and adverse weather conditions. Moreover, StreetJet offers a host of personalised control features and customisable styling options to cater to users of all ages and preferences. Simply dock your wheelchair, and embark on your journey with ease and confidence!



For more information, or to arrange a free home demonstration, visit [sunrisemedical.co.uk](https://www.sunrisemedical.co.uk)

Empulse | Naidex

15% OFF EMPULSE STREETJET*

With this incredible offer, you can save up to £600 off your Empulse StreetJet, making it easier than ever to experience the cutting-edge features and advanced technology that StreetJet has to offer.

Speak to a member of staff for more information or to book your assessment.

[Book Your Assessment
Today To Qualify](#)

*EMPLUSE OFFER TERMS & CONDITIONS: When you purchase an Empulse StreetJet. To qualify for this offer you must book a demonstration of an Empulse StreetJet power and show this card when placing your order for a new StreetJet. These offers cannot be retro-fitted or applied to any existing wheelchairs. Orders must be placed within 30 days of the initial assessment. The final date for orders to be placed for the offer to be valid is May 31st 2024. Cannot be used in conjunction with any other Sunrise Medical or Quickie offer. The promoters reserve the right to withdraw or amend this offer without prior notice. No cash alternative option available. Not available for products purchased via Wheelchair Service or Personal Wheelchair Budget (NHS). Limited to one per person. Model versions may vary to images of products depicted. PROMOTER: Sunrise Medical, Thorns Road, Brierley Hill, West Midlands, DY5 2LD.



WIN YOUR DREAM CHAIR

See back cover
for more details

RRP: £1,500
Available to order now



Introducing The QS5 X - Unfold Your Freedom

Packed full of premium materials, state of the art technology and high end manufacturing techniques, all in an entry-level chair

Sunrise Medical is proud to unveiling of the new QUICKIE entry-level active manual chair, the QS5 X. This all-new chair weighs just 7.3kg, and is perfect for both first time and experienced users thanks to its premium materials and technology. Featuring innovations such as the new X-brace design, new fully integrated caster-house and best-in-class folding performance.

Super Lightweight

Weight is always a key factor when considering a manual chair. This is the lightest aluminium box frame folding wheelchair available on the market making it effortless to self-propel and easy to lift and load for users or caregivers. It's the material and construction that makes all the difference with this chair. High grade 7000 series aluminium has allowed us to gain an exceptionally high strength-to-weight ratio. By heat treating the aluminium, we have created a frame that is significantly thinner and lighter without sacrificing on strength.

The Convenience Of Smooth Folding

The QS5 X is easy to fold and it stays folded. The Freefold feature creates a precise lock between the seat saddle and bearing. Subsequently, the chair folds smoothly in and out of the seat-saddles and without unwanted camber and, when folded, the chair stays in an upright position. The oval tubing of the 4-arm cross brace is stronger and lighter than a round tube because it has fewer stress points and uses less material. This makes it less likely to flex under pressure, providing the highest rigidity and reduction in wobbling for a secure feeling when driving.

Patented Technology

Innovation is at the heart of what we do. That's why we're introducing a patented tip-tube which will flip up when meeting the kerb. It continues with the minimal and ergonomic design with no visible screws or holes. The QS5 X is highly customisable with options and a choice of 24 vibrant frame



colours and 4 anodised caster fork and caster rim colours to create the perfect look.

What's more, the relation of the distance between the caster and rear wheel is crucial for energy efficient propelling. The caster forks can also be easily adjusted by our patented 3-way adjustable mechanism. Due to the precise adjustability, the QS5 X always stays on track, and you are spared inefficient counter steering.

Ergonomic Touchpoints

The features of this chair are endless so we'll end on the touch points on the caster links, knee-bend and back frame that provide a comfortable grip and prevent slipping. Rider-input is integral to our design process, and innovations such as these touch points are born from the feedback we receive. They allow for easy lifting, reducing strain



on wrists especially during daily use and they have the added benefit of protecting the frame from scratches.

Sleek And Modern Lines

The QS5 X features a minimal design aesthetic complete with hidden adjustments and seamlessly integrated caster link tubes. There are no visible screws or holes to compromise the aesthetic giving it a stylish and sophisticated appearance. It's like nothing you've ever seen before from an entry level active manual chair representing a step-change in wheelchair design.

The optional Fold-N-Lock locking conveniently keeps the chair securely folded, and with a simple "click" the wheelchair can remain in a compact fold. This makes lifting and storing so much easier as it eliminates the requirement to hold the chair closed.

Loaded with big features and performance to meet most clinical and lifestyle needs, the QS5 X offers precise adjustability in a chair that is simply unrivalled in its field.

For your chance to win a brand new QS5 X, configured to your specifications see the back cover or visit the QUICKIE Wheelchair UK Facebook page for the more details.

For more information on the QS5 X, or to arrange a free home demonstration, visit sunrisemedical.co.uk

The QUICKIE Nitrum

Precision-engineered to turn your energy into motion

Breaking new ground in the realm of ultralight, energy-efficient active wheelchairs, the QUICKIE Nitrum has soared above expectations. Positioned as a superior counterpart to the Argon 2, the Nitrum, stands as the epitome of lifting ease and energy efficiency, making it the go-to choice for daily functionality and fleet use.

The QUICKIE Nitrum sets a new benchmark in ultralight wheelchairs, surpassing the Argon 2 by an impressive 12%. Crafted from cutting-edge 7020 Aluminium, the Nitrum combines proven technology from the QUICKIE Helium, ensuring an exceptional strength-to-weight ratio. Its **oval frame design**, slimline clamps, and strategic bar placement not only reduce weight but enhance overall strength. The result? A lifting weight of just **4.9 kg**, redefining expectations for lightweight wheelchairs. The Nitrum is a masterpiece of engineering, seamlessly blending advanced materials and innovative design for an unparalleled experience in mobility.

The Nitrum also sets a new standard in energy efficiency and rolling performance. **7020 Aluminium** not only makes the chair ultra-lightweight but also minimises frame flex, ensuring energy translates into forward motion. A novel backrest mechanism enhances frame stiffness, reducing play and maximising energy transfer. The **hollow forged castor housing**, formed through high-pressure forging, yields a robust yet lightweight material, elevating manoeuvrability.

Setting the Nitrum apart from the Argon 2 is the emphasis on **fine-tuned adjust-ability**. With optimised pre-set castor house positions, the Nitrum ensures improved front stability. The introduction of an innovative multi-adjustable castor housing offers unparalleled flexibility, allowing users to make precise angle, height, and lateral adjustments for enhanced rolling efficiency. Notably, the Nitrum's unique castor height adjustment guarantees consistent four-wheel contact, providing a 3mm range of adjustment on each castor wheel. This unprecedented level of adjust-ability positions the Nitrum as a trailblazer in optimising rolling efficiency for a superior user experience.

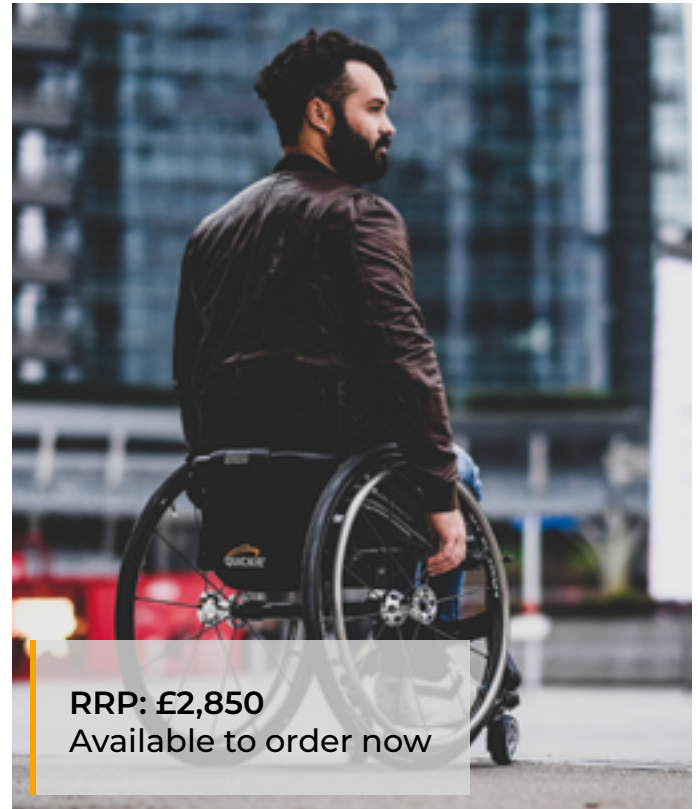

RRP: £2,850
Available to order now

The Nitrum also redefines daily functionality with its user-centric features. The **twist-to-lock backrest** folding, with an ergonomic grip, ensures secure one-handed operation. For an alternative, the **push bar release** offers a smooth folding experience. Introducing **fold-in side guards** simplifies processes, enhancing car transfer clearance. The **compact brake**, now strengthened and 180g lighter, ensures durability for seamless daily use. Nitrum is not just a wheelchair; it's a companion in effortless daily activities.

The QUICKIE Nitrum exceeds expectations, combining ultimate lightness with unrivalled rolling performance. Designed for daily functionality and sets a new standard in the world of ultralight, active wheelchairs.

For more information, or to arrange a free home demonstration, visit [sunrisemedical.co.uk](https://www.sunrisemedical.co.uk)



Naidex

FREE Spinergy Wheels Worth £595 When You Book An Assessment Today On An QUICKIE Active Manual*

Why settle for basic wheels when you can upgrade to 18 or 12 spoke Spinergy wheels at no extra cost when you purchase a QUICKIE active manual wheelchair.

Speak to a member of staff for more information or to book your assessment.

**Book Your Assessment
Today To Qualify**

*QUICKIE WHEELCHAIR OFFER TERMS & CONDITIONS: When you purchase one of the following: Q55 X, Argon2, Xenon2, Nitrum, Krypton R / F. To qualify for this offer you must book a demonstration of a QUICKIE wheelchair on Sunrise Medical stand at Naidex 20th – 21st March 2024 and show this card when placing your order for a new Quickie wheelchair. These offers cannot be retro-fitted or applied to any existing wheelchairs. Orders must be placed within 30 days of the initial assessment. The final date for orders to be placed for the offer to be valid is August 31st 2024. Cannot be used in conjunction with any other Sunrise Medical or QUICKIE offer. The promoters reserve the right to withdraw or amend this offer without prior notice. No cash alternative option available. Not available for products purchased via Wheelchair Service or Personal Wheelchair Budget (NHS). Limited to one per person. Model versions may vary to images of products depicted. PROMOTER: Sunrise Medical, Thorns Road, Brierley Hill, West Midlands, DY5 2LD.



RRP: £3,850
Available to order now

Less To Lift. More To Love.

Introducing the Q50 R Carbon, our lightest ever folding powerchair

The QUICKIE Q50 R Carbon is our lightest ever folding powerchair, weighing just 14.5kg. Trust us, lifting is believing in this case.

Whatever your destination, the Q50 R Carbon is your perfect travelling partner. Fabricated from carbon fibre, the chair is effortless to lift, foldable in seconds and stores neatly away thanks to its ultra-compact design.

This ingenious, space-saving powerchair folds in seconds with no troublesome mechanisms - ideal for storing neatly away until you get the urge for adventure. It's also compact enough for transportation, suitable for cruises, holiday homes, and car boot transport. Looking to travel abroad? The Q50 R Carbon's Lithium-Ion battery is IATA

approved* (International Air Transport Association) for transportation by aircraft. Also, thanks to its rear anti-tips, even when folded the Q50 Carbon is easy to move around. It can even be charged when folded as there's no need to remove the battery.

Whether it's at home, a bustling shopping centre or crowded public transport, the Q50 R Carbon's compact size and precision control gets out of any tight indoor situation - thanks to its slim 600mm base and 800mm turning circle. It also boasts an unmatched range of up to 24km, large 12" drive wheels and dual suspension that cushions impact when driving over rougher terrain.

With premium user comfort in mind, the net backrest allows body heat to pass through, keeping

* Individual airlines have differing requirements relative to transport of products with Li-Ion batteries. Prior to arranging any air travel with the wheelchair, please confirm with your airline or carrier that they accept battery-powered vehicles under UN classification: UN3171. Please refer to the owners manual for further details.



users cool and dry on long trips. The adjustable sling seat provides extra-give while driving over undulating terrain for greater comfort, and features 5cm soft foam cushioning.

The Q50 R Carbon has a premium quality carbon frame design making it light, but incredibly strong. This carbon frame can naturally flex over uneven surfaces, providing unique shock absorbing characteristics to deliver one of the smoothest, most efficient rides around. What's more, the incredible light weight of the chair does not compromise on maximum user weight as it can accommodate up to 136kg. The reduced motor noise and high torque motors are built to stand the test of time and urban off-road use, and its quality assurance offers a 5-year frame warranty and 2-year warranty on the controller, battery and motors.



Alongside additional options such as storage pouches, the Q50 R Carbon's elegant frame can be customised with a selection of 5 accent colours in blue, black, purple, red and yellow.

For more information, or to arrange a free home demonstration, visit [sunrisemedical.co.uk](https://www.sunrisemedical.co.uk)



Naidex

FREE Extra Power Pack When You Purchase A Q50 R Carbon*

Save up to £350 and travel for longer with a free extra power pack when you purchase a Q50 R Carbon folding powerchair at Naidex.

Speak to a member of staff for more information or to book your assessment.

Book Your Assessment Today To Qualify



*QUICKIE WHEELCHAIR OFFER TERMS & CONDITIONS: When you purchase a QUICKIE Q50 R Carbon. To qualify for this offer you must book a demonstration of a QUICKIE wheelchair on Sunrise Medical stand at Naidex 20th - 21st March 2024 and show this card when placing your order for a new Q50 R CARBON. These offers cannot be retro-fitted or applied to any existing wheelchairs. Orders must be placed within 30 days of the initial assessment. The final date for orders to be placed for the offer to be valid is August 31st 2024. Cannot be used in conjunction with any other Sunrise Medical or QUICKIE offer. The promoters reserve the right to withdraw or amend this offer without prior notice. Not available for products purchased via Wheelchair Service or Personal Wheelchair Budget (NHS). Limited to one per person. Model versions may vary to images of products depicted. PROMOTER: Sunrise Medical, Thorns Road, Brierley Hill, West Midlands, DY5 2LD.

Elevate Your Mobility Experience

Introducing the Q700 M series with a selection of seating options to fit any comfort or lifestyle needs

Experience superior outdoor performance and enhanced comfort without sacrificing maneuverability with the QUICKIE Q700 M series. Designed for intuitive driving and tight indoor spaces, this mid-wheel drive powerchair offers the best of both worlds.

Empower your mobility without compromising on comfort or budget with our range of tailored seating options. Enjoy the freedom to select the perfect fit for your individual lifestyle needs within the Q700 M series, where comfort meets adaptability.

Q700 M PRO:

Equipped with essential power features such as lift, tilt, anti-shear recline, and power leg rests, the Q700 M PRO allows effortless repositioning at the touch of a button, ensuring tailored comfort.

Q700 M ADVANCED PRO:

Designed for superior functionality, the Q700 M ADVANCED PRO boasts the same features as

the Q700 M PRO model with added benefits like lay-flat and partial stand capabilities, promoting excellent posture during transitions.

Q700-UP M ADVANCED:

Loaded with cutting-edge standing technology, the Q700-UP M ADVANCED combines all the features of the ADVANCED PRO model at an affordable price point, offering premium lifestyle and postural features with unmatched value.

Now that you've explored the entire Q700 M series, which model will you choose to experience first-hand?

For more information, or to arrange a free home demonstration, visit [sunrisemedical.co.uk](https://www.sunrisemedical.co.uk)



Q700 M Pro



Q700 M Advanced Pro



Q700 UP-M Advanced



Magic Mobility: Master Any Terrain, No Matter The Weather

Conquer any landscape with the ultimate off-road wheelchair experience

As the chilly embrace of colder months settles in, wheelchair users find themselves navigating challenges associated with their power wheelchairs' traction in adverse weather conditions. Recognising this concern, Magic Mobility proudly presents its all-terrain powered wheelchairs, designed to not only overcome traction issues but also to empower users to embrace the freedom and adventure that comes with a go-anywhere powered wheelchair.

Magic Mobility Magic 360: Unleashing True Off-Road Capability

With an impressive 25 years of expertise in crafting off-road wheelchairs, Magic Mobility introduces the ground breaking Magic 360. This powerchair stands out as the world's first everyday powerchair with genuine off-road capability. Hailing from the heart of Australia, the Magic 360 seamlessly combines the compact maneuverability needed for home use with all-terrain technology, providing users with an unparalleled 360° freedom experience.

Every element of the Magic 360, from its meticulously designed chassis and suspension to its robust motors, drive wheels, and batteries, is a testament to Magic Mobility's commitment to delivering optimal off-road performance. Drawing inspiration from their proven product portfolio, the Magic 360 effortlessly handles diverse terrains, pushing the boundaries of what an everyday powerchair can achieve.

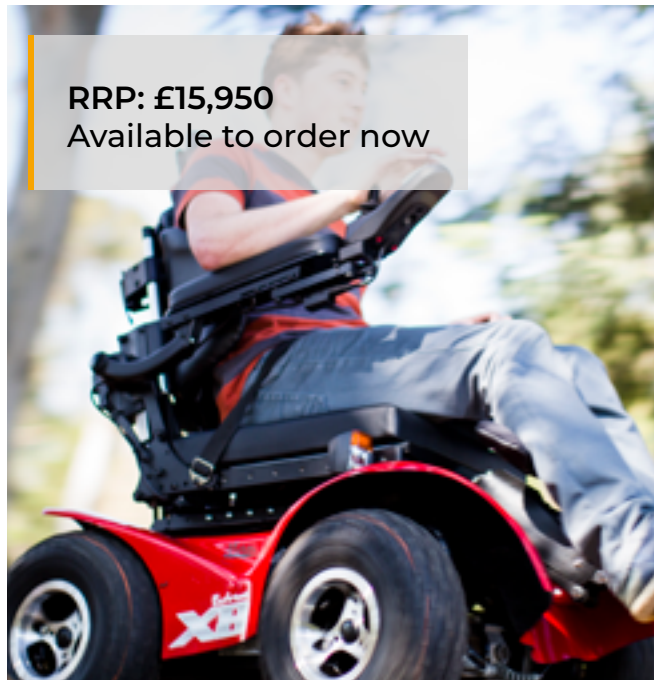
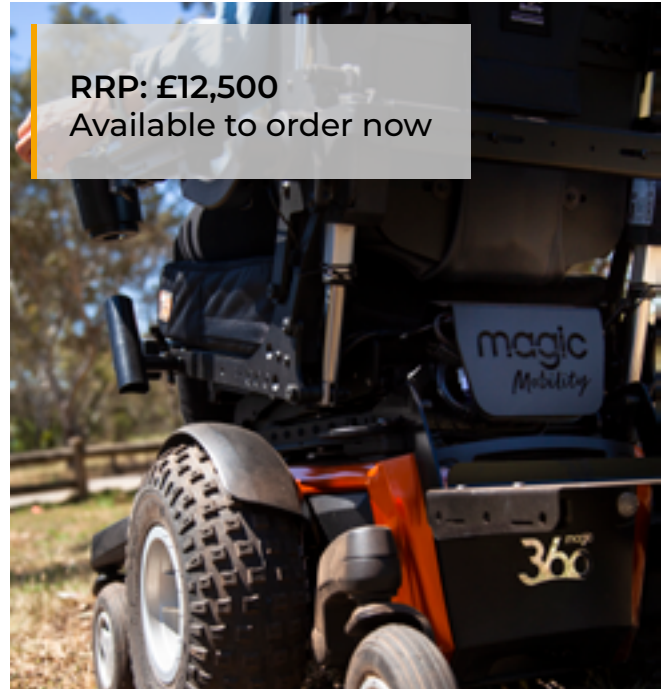

Magic Mobility Extreme X8: Your All-Terrain Partner

Designed for adventurers and rural enthusiasts, the Extreme X8 is more than an ordinary outdoor wheelchair. With outstanding suspension and low-pressure knobby tires, it excels on diverse terrains, offering a genuine all-terrain experience. High-torque motors provide a top speed of 6.2mph, confidently tackling challenging landscapes. With four independent motors, all-terrain tires, and articulating front suspension, the Extreme X8 effortlessly conquers kerbs and small steps, expanding possibilities for versatile mobility.

In a world where outdoor adventures beckon and reliable off-road performance is non-negotiable, the Magic Mobility range stands tall as a testament to innovation, comfort, and the unwavering pursuit of true all-terrain mobility. Whether it's the ground breaking Magic 360 or the robust Extreme X8, Magic Mobility delivers not just wheelchairs but gateways to boundless freedom.

For more information on the full Magic Mobility range, or to book a free home demonstration, visit [sunrisemedical.co.uk](https://www.sunrisemedical.co.uk)

Which Power Function Is Right for You?

Exploring Options for Your Power Wheelchair

Choosing the right power function for your wheelchair can significantly enhance your mobility experience, aligning with both your clinical requirements and lifestyle preferences. Here's a breakdown of popular power functions and their benefits:

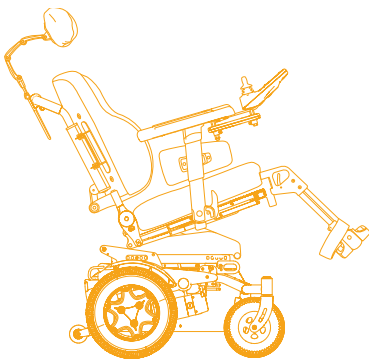

Tilt:

Ideal for individuals seeking pressure relief and enhanced comfort throughout the day. Tilt-in-space functionality allows for effortless adjustment, redistributing pressure and promoting better posture.

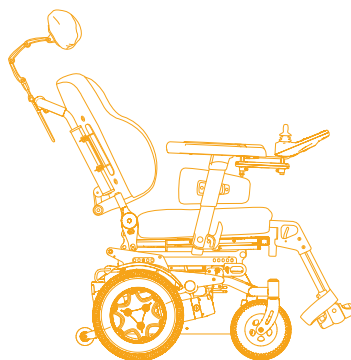

Recline:

Offering versatility and convenience, recline functionality enables independent repositioning with the push of a button. Perfect for users who require frequent changes in seating position for comfort and support.

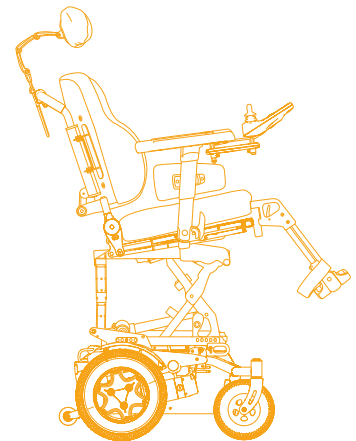

Power Lift:

Experience greater accessibility and improved communication with power lift functionality. Easily elevate to eye level for seamless interaction with your environment and others.

Understanding the unique advantages of each power function enables you to make an informed decision based on your specific needs and preferences. Whether you prioritise pressure relief, versatility, or accessibility, there's a power function tailored to optimise your mobility and overall comfort.

Consult with your healthcare provider or mobility specialist to explore which power function aligns best with your individual requirements. With the right choice, you can enjoy enhanced mobility and independence, enriching your daily life experiences.

Explore the full range of QUICKIE power wheelchairs at [sunrisemedical.co.uk](https://www.sunrisemedical.co.uk)



Naidex

FREE Powered Lift & Tilt Worth £2,050 When You Book An Assessment Today*

Book an assessment on our stand and receive a complimentary Powered Lift & Tilt upgrade with your purchase of the QUICKIE Q300 M Mini, Q500 M, or Q700 M Pro.

Speak to a member of staff for more information or to book your assessment.

Book Your Assessment Today To Qualify

*QUICKIE WHEELCHAIR OFFER TERMS & CONDITIONS: *When you purchase one of the following Q300 M Mini, Q500 M & Q700 M Pro powered wheelchair. To qualify for this offer you must book a demonstration of a QUICKIE wheelchair on the Sunrise Medical stand at Naidex 20th – 21st March 2024 and show this card when placing your order for a new QUICKIE wheelchair. These offers cannot be retro-fitted or applied to any existing wheelchairs. Orders must be placed within 30 days of the initial assessment. The final date for orders to be placed for the offer to be valid is August 31st 2024. Cannot be used in conjunction with any other Sunrise Medical or QUICKIE offer. The promoters reserve the right to withdraw or amend this offer without prior notice. No cash alternative option available. Not available for products purchased via Wheelchair Service or Personal Wheelchair Budget (NHS). Limited to one per person. Model versions may vary to images of products depicted. PROMOTER: Sunrise Medical, Thorns Road, Brierley Hill, West Midlands, DY5 2LD.



Scan the QR code with your phone's camera to access the visualiser.



WIN YOUR DREAM CHAIR

We're thrilled to announce our latest giveaway where you could win a brand new QUICKIE QS5 X folding manual wheelchair of your own design.

Here's how to enter:

1

CREATE

Head over to our **online visualiser** and build your ultimate QS5 X

2

POST

Share your design on Facebook and tag **@quickiewheelchairsuk**

3

LIKES

Get as many **likes** as you can on your design post to win

Post with the highest numbers of likes wins. Sharing & tagging your friends may help you reach higher number of likes. Giveaway ends 31st March 2024.

T&Cs apply.



IMPROVING PEOPLE'S LIVES®

Thorns Road, Brierley Hill, West Midlands, DY5 2LD
t: +44 (0)845 605 6688 | e: marketing@sunmed.co.uk

sunrisemedical.co.uk