



Customer Contact Details

<p>Customer Name: _____</p> <p>Advisor: _____</p> <p>Address: _____</p> <p>_____</p> <p>_____</p> <p>Phone: _____</p> <p>Email: _____</p>	<p>Ship to Customer Address: <input type="checkbox"/></p> <p>Shipping Name: _____</p> <p>Shipping Address: _____</p> <p>_____</p> <p>_____</p> <p>Phone: _____</p> <p>Email: _____</p>
---	--

Additional Information

<p>Notes: _____</p> <p>_____</p> <p>_____</p> <p>_____</p>	<p>Current Wheelchair: _____</p> <p>Customer Weight: _____</p> <p>Customer Height: _____</p> <p>Customer Disability: _____</p>
--	--

Other

<p>VAT Exemption Declaration (UK Only):</p> <p>I declare that I am chronically sick or disabled by reason of:</p> <p>_____</p> <p>and that I am receiving from RGK Wheelchairs Ltd, the wheelchair specified herein and I claim relief from Value Added Tax under group 12 of schedule 8 to Value Added Tax Act 1994.</p> <p>Signature: _____ Date: _____</p>	<p>RGK Contact Authorisation:</p> <p>From time to time, RGK would like to send you exclusive information, news and offers on everything RGK, by email or post. We will not pass any of your details to any third party.</p> <p>I would like to be contacted by RGK: <input type="checkbox"/></p> <p>Signature: _____ Date: _____</p>
--	---

Guide:

- Base product
- Required option
- Optional Extra
- Critical Information
- Information Needed

PRODUCT STYLE

- ECAXZ010** ELITE CX
- XA600 Heat treated frame
- ECAXA062 Standard
- ECAXA063 Standard with 25mm seatrail

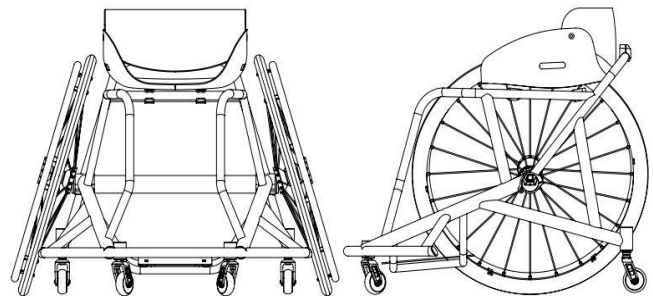

Max User Weight 125kg (275lbs)

PLEASE NOTE: ALL RGK CHAIRS ARE HAND BUILT AND HAVE A MANUFACTURING MEASUREMENT TOLERANCE OF +/- 5MM

CAD APPROVAL

- XW009 QUOTE ONLY (NO CAD FOR APPROVAL)
- XW011 ORDER (NO CAD FOR APPROVAL)
- XW012 QUOTE CAD drawing for approval (2 customer amendments ONLY)
- XW010 ORDER CAD drawing for approval (2 customer amendments ONLY)

KEY FRAME MEASUREMENTS

XY010 Seat width (Inside to inside of sideguards)

mm
(Max - 390mm)
(Min=270mm)

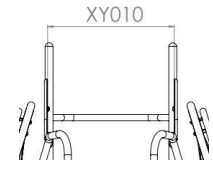

- Select CX shell width (optional)
- A-330mm XY010 = 270-315
 - B-355mm XY010 = 295-340
 - C-380mm XY010 = 320-365
 - D-405mm XY010 = 345-390

Note: CX Shell Seat Taper

	Seat Taper	Seat length (mm)			
		250	300	350	400
Seat width (mm)	330	305	280	255	230
	355	330	305	280	255
	380	355	330	305	280
	405	380	355	330	305

Hard foam will be used to get Seat width

XY020 Seat length

mm
Std = 20mm less than seat upholstery
(Max - 500mm)

XY030 Extra seat length (Provides additional leg support & hand grip)

mm

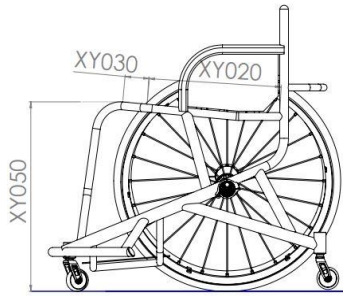

ECAXY050 Front seat height (Floor to middle of seat without cushion)

mm
(Max - 630mm)
(Min - 360mm)

ECAXY060 Rear seat height (Floor to middle of seat without cushion)

mm
(Max - 630mm)
(Min - 360mm)

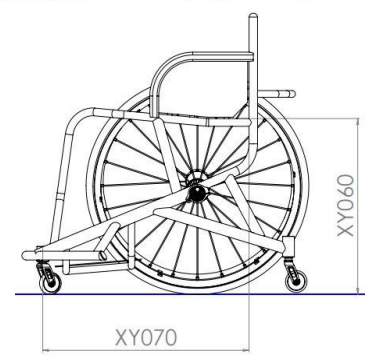

XY070 Frame length

mm
(Min = XY020 + XY030 + 140mm)

FRONT FRAME

XY080 Seat taper design

Specify taper width

mm

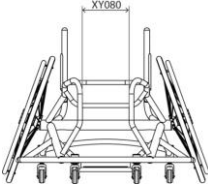

FOOTREST

Footrest Type

ECAXB080 Fixed position footrest

ECAXB145 Multi position footrest tubes



Footrest Measurements

Front footrest height

mm (min = 35mm)



Footrest width

mm (Std= 200mm)

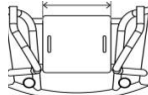

Rear footrest height

mm (min = 35mm)



Footrest length

mm (Std = 250mm)

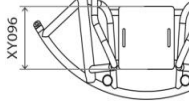

Footrest position
(front of footplate to castor pot)

mm

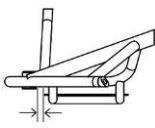

Footrest Plate

XB190 Carbon fibre footplate

ECAXB140 Spacer kit
(Allows for 25mm increase in height)

XB100 ABS moulded foot tray

Specify length

mm *Max = 380mm (Full)
Std = 330mm*

Footrest Plate Options

XB240 Aluminium raised edges
(Cost per Edge)

Front Back Left Right

Specify height

mm (Max = 60mm)

XB250 Carbon Fibre raised edge
(1 side only)

Front Back

Specify height

mm (Max = 45mm)

Castor Pin Width

XY330 Castor pin width

mm **MAX 320mm**

Optimise measurements



CAMBER BAR, WING AND ANTI-TIP

Centre of Gravity and Camber Angle

ECAXY510 Fixed centre of gravity

Specify measurement

mm

XY390 Camber angle

18
 20

Wing Options (Choose one)

ECAXA110 Round design basketball wing

ECAXA125 Arrow design basketball wing

ECAXA120 Straight sided design basketball wing

Anti-tip options (Choose one)

ECAXJ040 Single fixed anti tip

ECAXJ060 Double fixed anti tip

CX SIDES

Side Measurements

Sideguard height
(std = 150mm)(follow tyre)(Max = 180)

mm

Backrest depth
(std = 120mm)(Max = 150)

mm

Individual Shape

BACKREST

Backrest Height (Choose One)

XY230 Fixed backrest height

Specify height

mm





Backrest depth **top**
(distance from front of back post to middle of upholstery)

mm

Backrest depth **bottom**
(distance from front of back post to middle of upholstery)

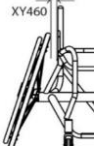
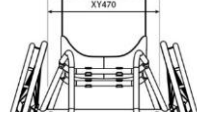
mm

Note: Take measurement from existing chair

CASTOR AND REAR WHEELS			
Castor Options			
<input type="checkbox"/> XC160 Sport 61mm castor (Black) <input type="checkbox"/> XC200 Sport micro fork	<input type="checkbox"/> XC181 Bones Reds bearings (All castor bearings) <input type="checkbox"/> XC182 Bones Swiss Ceramic bearings (All castor bearings)		
Rear Wheel Size			
<input type="checkbox"/> XY420 24" Wheels	<input type="checkbox"/> XY430 25" Wheels	<input type="checkbox"/> XY440 26" Wheels	<input type="checkbox"/> XY450 700C Wheels
Rear Wheel Gap			
<input type="checkbox"/> XY460 Rear wheel gap 	<input type="checkbox"/> XY470 Inside to inside of wheel 		
 <div style="display: flex; justify-content: space-around; width: 100px;"> 15202530 </div> <div style="border: 1px solid black; width: 100px; height: 20px; margin-top: 5px;"></div> <p style="font-size: 8px; margin-top: 2px;">Individual mm</p>	OR  <div style="border: 1px solid black; width: 100px; height: 20px; display: inline-block;"></div> mm		
Rear Wheel Options			
<input type="checkbox"/> XK080 Spinerger SLX 24 spoke <input type="checkbox"/> XK101 Spinerger XSLX 24 spoke + Caps Spinerger Colour Options: 	<input type="checkbox"/> XK330 Spinerger SLX R10 heavy duty 24 spoke (18 deg camber angle only) <input type="checkbox"/> XK521 Spinerger Ceramic bearing upgrade <input type="checkbox"/> XK180 Individual spoke design (Specify colour) Inside: _____ Outside: _____		
<input type="checkbox"/> Black spokes <input type="checkbox"/> White spokes <input type="checkbox"/> Yellow spokes <input type="checkbox"/> Red spokes <input type="checkbox"/> Blue spokes <input type="checkbox"/> Pink spokes <input type="checkbox"/> Purple spokes <input type="checkbox"/> Orange spokes <input type="checkbox"/> Green spokes	<input type="checkbox"/> XK190 Black hub (std option) <input type="checkbox"/> XK200 Silver hub <input type="checkbox"/> XK201 Red hub/rims <input type="checkbox"/> XK205 Individual hub/rims Select colour: <input type="checkbox"/> XK202 Purple hub/rims <input type="checkbox"/> XK203 Blue hub/rims <input type="checkbox"/> XK204 Gold hub/rims		
Supply Without Wheels			
<input type="checkbox"/> XK040 Supply without Wheels	 <div style="display: flex; justify-content: space-between;"> <div style="border: 1px solid black; width: 150px; height: 20px; display: inline-block;"></div> <div style="border: 1px solid black; width: 150px; height: 20px; display: inline-block;"></div> </div>		
Handrim Position / Options			
<input type="checkbox"/> XY480 Narrow set handrim <input type="checkbox"/> XL090 Remove excess mounting tabs (recommended for small wheel gaps)	<input type="checkbox"/> XY485 Wide set handrim <input type="checkbox"/> XL080 Super narrow set handrim (only with XL040 and includes XL090)		
Handrim Style			
<input type="checkbox"/> XL010 Aluminium hard anodised 6 tab <input type="checkbox"/> XL070 Aluminium hard anodised 12 tab (24" not available)	<input type="checkbox"/> XL040 Titanium 6 tab (Not with 700C) <input type="checkbox"/> XL050 Stainless steel 6 tab		
Tyre Options			
<input type="checkbox"/> XM070 Kenda Kaliente <input type="checkbox"/> Red <input type="checkbox"/> Blue <input type="checkbox"/> XM150 IRC Exeracer Pro (Red Only) <input type="checkbox"/> XM080 Tufo MS3 tubeless (Blue only)	<input type="checkbox"/> XM095 Kenda Wide (Grey Only)		
Spare Wheel			
<input type="checkbox"/> ECAXK500 Spare wheel Spinerger (Built up + axle pin) <input type="checkbox"/> XK520 Spare wheel upcharge - Titanium Rims <input type="checkbox"/> XK522 Spare wheel upcharge - Remove Excess Tabs	<input type="checkbox"/> XK523 Spare wheel upcharge - Individual Hubs/Rims <input type="checkbox"/> XK524 Spare wheel upcharge - Individual Spoke Colour		
Inner Tube Valve Options			
<input type="checkbox"/> XY500 Schraeder inner tube valve	<input type="checkbox"/> XY490 Presta inner tube valve (Standard if no option selected)		

FINISH OPTIONS

Frame finish

XN010 Powder coated frame

Frame	Gloss	Frame	Matt	Frame	Special
<input type="checkbox"/>	<input type="checkbox"/> Black gloss 103	<input type="checkbox"/>	<input type="checkbox"/> Black matt 105	<input type="checkbox"/>	<input type="checkbox"/> Chrome Mirror 300
<input type="checkbox"/>	<input type="checkbox"/> White gloss 100	<input type="checkbox"/>	<input type="checkbox"/> White matt 101	<input type="checkbox"/>	<input type="checkbox"/> Sparkle silver 170
<input type="checkbox"/>	<input type="checkbox"/> Grey gloss 132	<input type="checkbox"/>	<input type="checkbox"/> Grey matt 131	<input type="checkbox"/>	<input type="checkbox"/> Metallic black matt 104
<input type="checkbox"/>	<input type="checkbox"/> Cream gloss 135	<input type="checkbox"/>	<input type="checkbox"/> Light grey matt 133	<input type="checkbox"/>	<input type="checkbox"/> Metallic grey matt 130
<input type="checkbox"/>	<input type="checkbox"/> Red gloss 108	<input type="checkbox"/>	<input type="checkbox"/> Navy blue matt 152	<input type="checkbox"/>	<input type="checkbox"/> Black sandpaper 201
<input type="checkbox"/>	<input type="checkbox"/> Yellow gloss 120			<input type="checkbox"/>	<input type="checkbox"/> Grey sandpaper 202
<input type="checkbox"/>	<input type="checkbox"/> Forest green gloss 143			<input type="checkbox"/>	<input type="checkbox"/> White sandpaper 200
<input type="checkbox"/>	<input type="checkbox"/> Green gloss 107				
<input type="checkbox"/>	<input type="checkbox"/> Dark blue gloss 151	<input type="checkbox"/>	<input type="checkbox"/> XN200 Individual paint colour (State Colour/RAL code)		
<input type="checkbox"/>	<input type="checkbox"/> Royal blue gloss 154				
<input type="checkbox"/>	<input type="checkbox"/> Blue gloss 174				
<input type="checkbox"/>	<input type="checkbox"/> Duckegg blue gloss 141				
<input type="checkbox"/>	<input type="checkbox"/> Pink gloss 188				
<input type="checkbox"/>	<input type="checkbox"/> Orange gloss 180				
<input type="checkbox"/>	<input type="checkbox"/> Purple gloss 157				

ECAXN030 Brushed frame
 ECAXN050 Polished frame

Accent Colour

Note: Accent colour includes, forks, castor caps, and decals.

<input type="checkbox"/> Black accent	<input type="checkbox"/> Silver accent	<input type="checkbox"/> XN250 Individual accent
<input type="checkbox"/> Red accent	<input type="checkbox"/> Blue accent	<input style="width: 150px; height: 30px;" type="text" value="Select Colour:"/>
<input type="checkbox"/> Purple accent		

orders@rgkwheelchairs.com

6 OF 8

RGK_ELITE-CX_2024_V1_EUR
ENGLISH

CUSHION

Cushion foam options

XP200 CX seat and backrest upholstery

Seat cushion foam thickness

7mm 10mm 25mm 50mm Individual thickness

Backrest foam thickness

7mm 10mm 25mm 50mm Individual thickness

Indicate Max Height:

580mm 630mm

Seat cushion foam type:

Soft Med Plastazote Hard

Backrest foam type:

Soft Med Plastazote Hard

STRAPPING

Velcro straps

XS050 100mm Pro adjustable velcro strap

XS055 50mm Pro adjustable velcro strap

XS057 50mm Pro adjustable velcro **Knee strap**
(measurement from tube to tube over knees)

Velcro strap position

Strap 1

Specify strap length

Specify distance from back post

Strap 2

Specify strap length

Specify distance from back post

Ratchet Straps

XS020 Sport ratchet strap (Click strap)
(11" x 2" pad)

XS021 Sport ratchet strap (Single)

XS025 Pelvi Loc 2DA ratchet strap
(For thighs and knees)

Select size:

Medium (12") Large (14")

XS030 Pelvi Loc 3DA ratchet strap
(For hips)

Select size:

S (8") M (12") L (14") XL (17")

XS035 M2 ratchet strap
(For thighs and knees)

8" 10" 12"

XS036 M2 ratchet strap (Single)
(For Feet)

8" 10" 12"

Ratchet strap position

Strap 1

Specify distance from back post

Strap 2

Specify distance from back post

XS040 Fixed mounting points
(one set per click strap) x1 x2 x3

FRAME OPTIONS

XR060 Calf strap mounting loops

XR065 Strap location loops

ACCESSORIES

XR030 Triple wheel bag
(Black)

XP130 Frame protectors full length

XA150 Plastic tube fitted to offensive wing

XS070 Foot strap *(select if required)*

XS060 Calf strap *(select if required)*

XP400 Back bar protector

XR090 Tool kit

ADDITIONAL NOTES

[Grid area for additional notes]	
----------------------------------	--

OFF SPEC REQUEST* *(please specify below the page number(s) and details to which the off spec request applies.*

OFF SPEC REQUEST APPROVED *(for internal RGK office only)*

X
RGK Internal Sign-off

Off spec requests require a feasibility study which may increase order price and lead time. Any dimension/ option/ frame request not listed on the order form will be treated as an off spec request.*