

LECKEY[®]

Everyday Activity Seat

User Instructions





The Everyday Activity Seat is a moderate seating system designed for use in the home and classroom. It comes in 3 sizes with adjustable seat height, depth and width to accommodate users from ages 1 to adult. This manual shows you how you can quickly and easily make use of all of the functions. The instructions on the safety and maintenance of the product will ensure that you will enjoy the use of this product for a long time.



Contents

- 01 Intended Use
- 02 Declaration of Conformity
- 03 Terms of Warranty
- 04 Product History Record
- 05 Product Training
- 06 Safety Information
- 07 How to unpack and assemble
- 08 Fitting the Cushions
- 09 Clinical setup for Postural Management
- 10 Frequent adjustments for daily use
- 11 Cleaning and Care Information
- 12 Daily Product Inspection
- 13 Annual Product Inspection
- 14 Reissuing Leckey Products
- 15 Product Servicing
- 16 Technical Information

1. Intended Use

The Everyday Activity Seat comes in 3 sizes catering for the needs of children with disabilities. As a guide, Size 1 is for kids aged 1-6, Size 2 is for 5-12 years, and Size 3 is for 11-18 years with a maximum user weight of 30kgs (110lbs), 50kgs (132lbs), and 100kgs (220lbs) respectively.

2. Declaration of Conformity

James Leckey Design Ltd. as manufacturer with sole responsibility declares that the Leckey Everyday Activity Seat conforms to the requirements of the 93/42/EEC Guidelines and EN12182 Technical aids for disabled persons, general requirements and test methods. C€

3. Terms of Warranty

The Warranty applies only when the product is used according to the specified conditions and for the intended purposes, following all manufacturer's recommendations (also see general terms of sales, delivery and payment). A three year warranty is provided on all Leckey manufactured products and components.

3a. Additional Warranty Information

For goods provided by Sunrise Medical Pty Ltd in Australia, our goods come with a guarantee by Sunrise that cannot be excluded under the Australian Consumer Law. You are entitled to a replacement or refund for a major failure and for compensation for any other reasonably foreseeable loss or damage. You are also entitled to have the goods repaired or replaced if the goods fail to be of acceptable quality and the failure does not amount to a major failure. The benefits to you given by this warranty are in addition to your other rights and remedies under a law in relation to the goods to which the warranty relates.

4. Product History Record

Your Leckey product is classified as a Class 1 Medical device and as such should only be prescribed, set up or reissued for use by a technically competent person who has been trained in the use of this product. Leckey recommend that a written record is maintained to provide details of all setups, reissue inspections and annual inspections of this product.

5. Product Training Record (Clients & Carers)

Your Leckey product is a prescribed Class 1 Medical Device and as such Leckey recommend that parents, teachers and carers using the equipment should be made aware of the following sections of this user manual by a technically competent person.

Section 6

Safety Information

Section 9

Clinical Setup for postural management

Section 10

Frequent adjustment for daily use

Section 11

Cleaning & Care Information

Section 12

Daily Product Inspection

Leckey recommend that a written record is maintained of all those who have been trained in the correct use of this product.

Name & Stamp of Distributor

6 Safety Information



6.1 Always read instructions fully before use.



6.2 Users should not be left unattended at any time whilst using Leckey equipment.



6.3 Only use Leckey approved components with your product. Never modify the product in any way. Failure to follow instructions may put the user or carer at risk and will invalidate the warranty on the product.



6.4 If in any doubt as to the continued safe use of your product or if any parts should fail, please cease using the product and contact our Customer Care Team or your local dealer as soon as possible.



6.5 Carry out all positional adjustments and ensure that they are securely fastened before you put the user into this product. Some adjustments may require the use of a tool which is provided with each product. Keep all tools out of reach of children.



6.6 When placing the user into the seat, for safety reasons, always secure the pelvic harness first.



6.7 When the product is stationary ensure that all four castors are locked and facing away from the base. This is especially important when the tilt-in-space and back recline facility is in use.



6.8 When the seat is in use please ensure that the height adjustment pedal or bolts and tilt-in-space are locked off and cannot be adjusted accidentally, especially if there are children in the area.



6.9 The Everyday Activity Seat is not a wheelchair and although mobility is an important feature of the seat, we do not recommend that users be moved over uneven surfaces whilst in the equipment. All due care and attention should be taken if transporting the user from one seat to another.



6.10 The Everyday Activity Seat has not been crash tested therefore cannot be used in your transport.



6.11 Never leave the product on a sloping surface greater than 5 degrees. Always remember to lock all the castors.



6.12 Only use the push handle to steer and move the seat from one area to another. Never use the tray for this purpose.



6.13 The product contains components which could present a choking hazard to small children. Always check that locking knobs and bolts within the child's reach are tightened and secure at all times.



6.14 Leckey products comply with fire safety regulations in accordance with EN12182. However the product contains plastic components and therefore should be kept away from all direct sources of heat including naked flames, cigarettes, electric and gas heaters.



6.15 Never place hot items on the Activity Tray as they may damage the plastic.



6.16 Clean the product regularly. Do not use abrasive cleaners. Carry out maintenance checks on a regular basis to ensure your product is in good working condition.



6.17 The product is designed for indoor use and when not in use should be stored in a dry place that is not subjected to extremes of temperature. The safe operating temperature range of the product is +5° to +40° Celsius.

How to unpack and assemble

Check parts

Congratulations on purchasing your Everyday Activity Seat. All of the parts ordered will be contained in polythene bags with each one clearly labelled. Carefully remove them from the boxes and check all of the parts you have ordered.



Keep polythene bags away from children.

Multi Tool

A number of adjustments will require the use of a multi tool, which is supplied with each seat.



7.1 Attaching the sandals/ Attaching the footplate straps (Wooden footplate accessory)

To attach the sandals simply unscrew the knob and washers from the sandal. Place the sandal onto the footplate positioning the screw through the slot and replacing the washers and knob. Repeat this for the other side.

Attaching Footplate Straps (Wooden footplate accessory)

Locate the footplate straps to suit the person's feet, and mark out the strap hole locations. Drill 7mm holes in the wooden footplate in the marked out strap hole positions. Fit the footplate straps to the wooden footplate by securing the socket cap, the washer and the nut. Tighten to secure.

Adjusting Footplate Straps

To remove padded footplate straps, pull Velcro strip away from the strap. To secure the padded foot strap around the user, pull the Velcro strip tightly and secure to the strap.



7.2 Attaching the armrests

Insert the armrest into the receiving bracket and secure at the desired height by tightening the knob (a).



7.3 Attaching the tray

To attach the grey, clear or black tray, insert the tray tubes through the centre of the armrests (a). To insert the wooden tray, insert the single tray tube into the centre of the right or left armrest depending on position required (b). Once the tray is located in position (clear, black, grey or wooden) the knob (c) should be tightened securely.



7.4 Attaching the hip laterals

Unscrew the knob (a) from underneath the seat base. Place the hip lateral bracket onto the screw (b). Replace and tighten the knob (c).

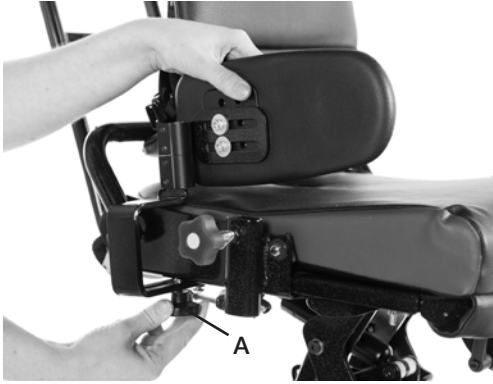

7.5 Attaching the standard and flipaway chest lateral supports

To attach the chest lateral supports, line the bracket up with the slots in the metal backrest. Insert the two allen key bolts through the small oval plate, then the backrest slot, and into the two sliding parts sitting in the bracket and tighten.

To gain extra height with the laterals, take them off, turn them upside down, and reattach the left one on the right hand side of the backrest and vice versa.



7.6 Attaching shoulder protraction pads

To attach the shoulder protraction pads, line the bracket up with the slots in the backrest. Insert the 2 allen key bolts and washers through the backrest slot and tighten into the protraction pad bracket.

7.7 Attaching the pommel

Insert the pommel bracket into the recess, insert the knob (a) and tighten.

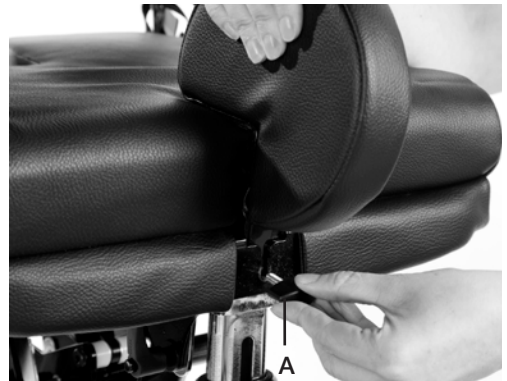

7.8 Attaching the footplate

For Size 1 and 2, slide the footplate over the calf angle tube (a) and tighten bolt (b). For Size 3, slide the footplate tubes over the calf angle support tubes (c) and tighten bolts on each calf support (d).

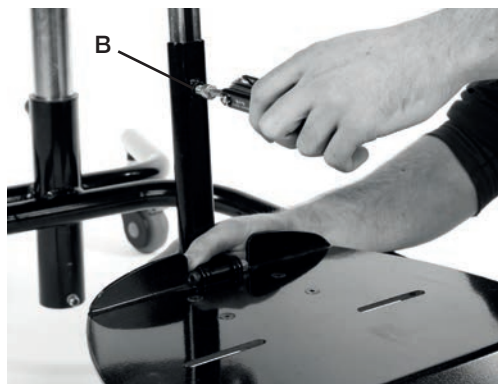

7.9 Attaching the abduction side pads

For size 1 and 2, with the seat in the maximum depth position, unscrew the knob from underneath the seat base. Place the abduction side pad bracket onto the screw (a) then replace and tighten the knob (b).

For size 3, line up the abduction side pad bracket with the slot at the front of the seat base when the seat is at maximum depth. Slide into the required position, insert bolt and tighten securely (c).



7.10 Attaching the pelvic harness

Open each camlock (a). Attach each of the 4 straps through the camlocks and continue to feed through to additional security triglide (b) then snap shut (c).



7.11 Attaching the Mygo headrest attachment bracket

Thread screws through the Mygo Headrest Attachment Bracket and Spacer Block. Align the assembly with the holes in the back plate and push through. Secure each end with bolt - tighten to secure.



7.12 Attaching the calf strap

Wrap the Calf Strap around the 2 Calf Support bars. Align the poppers on the Velcro strip and secure.



Once secured, slide the poppers around the back of the calf support struts to protect the user's legs.



7.13 Attaching the Push Handle

For Size 1, the push handle is attached to the chassis brackets by inserting the two lower stems into the receiving tubes as shown (a). For Size 2 and 3, the push handle is attached to the seat base by inserting the two lower stems into the receiving tubes as shown (b and c).

The push handle has safety poppers which need to be pressed in when inserting the lower stems. Push the stems in until the poppers protrude from the other end of the receiving tubes. For Size 1 and 2, secure the handle in place by tightening the bolt (d). For Size 3, secure the handle by tightening the locking knobs (e).

Check these regularly to make sure the bolt/locking knobs are tight, particularly if you are moving the product unit along corridors that may have uneven or sloping surfaces.



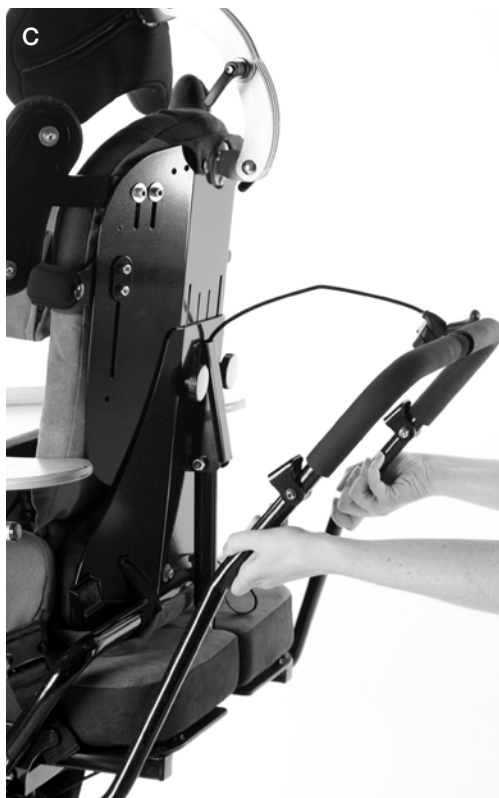

Fitting the Cushions

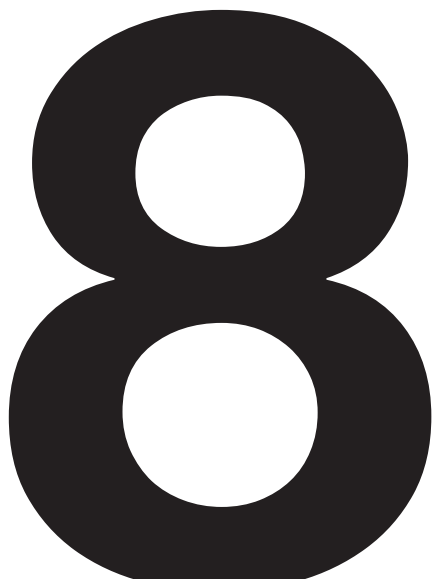

8.1 Backrest cushion

The backrest cushion can be attached by simply setting it onto the backrest, then pressing down to locate the snap fasteners at the top. Secure it to the Velcro on the backrest. Next, loop the appropriate piece of elastic length over the hook- there are 2 elastic lengths to choose from, a smaller length for a lower position and a longer length for a higher position.

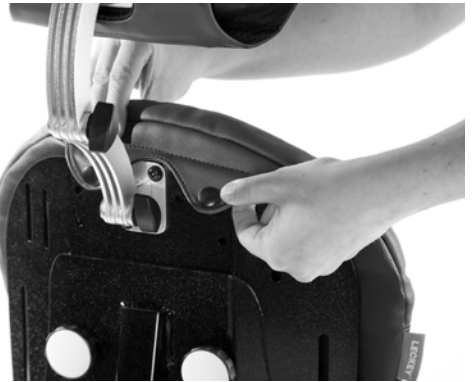

8.2 Seat base cushion

The seat base cushion can be attached by simply setting it in place, then pressing down to locate the snap fasteners (a) at the back of the seat base. Next, fold the cover underneath the front of the seat base and locate the snap fasteners (b). There is a section of material located in the centre of the seat base cushion which can be used to cover the pommel receiver bracket when the pommel is not being used. Pull this section of material down from underneath the seat base cushion and attach using Velcro strips at each side. When the pommel is in use, tuck this section underneath the seat base.

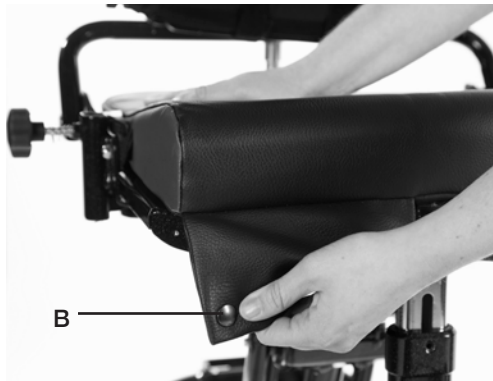

8.3 Chest lateral support covers

To attach the chest lateral support covers, simply slide the covers on the lateral support, with the zips on the outside. Feed the plastic buckle through the slot in the cover (a), then pull the zips located at the rear of the cover together to close (b).



8.4 Hip laterals

Slide the covers over the hip lateral hardware with the zips on the outside (a). Pull the zips located at the rear of the cover together to close (b).



8.5 Hip lateral bracket cover

Slide the cover around the bracket until it covers the angle adjustment mechanism, pull the tab over the top of the angle adjustment and press the snap fastener.



8.6 Contoured Head support cover

Place the cover over the head support and zip closed to secure.



8.7 Chest harness

The chest harness can be attached by clipping the male buckle (a) into the female buckle at either side of the lateral support.



8.8 Attaching the trunk harness

With your trunk harness you will receive two adjustable side straps, two adjustable shoulder straps, four camlock attachment clips (two with webbing straps attached, two without), two countersunk bolts, two button head bolts and four locking nuts. Attach the shoulder straps and side straps at the top (a) and bottom (b) using a spanner and multi tool. Then connect the shoulder straps (c) into the two clips at the top and two at the side.

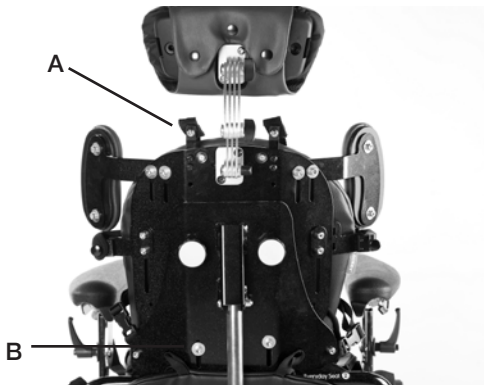

8.9 Abduction side pad cover

Place cover over abduction side pad, close zips at both sides to secure.



Clinical Setup for Postural Management

The clinical setup of the product should be completed by a technically and clinically competent person who has been trained in the use of the product. Leckey recommend that a written record is maintained of all clinical setups for this product.

Set the backrest height, seat depth and footplate height before placing the child in the seat. These can be fine tuned when the child is in the seat.



9.1 Pelvic harness

For side adjustment, open the camlocks and either pull the straps to tighten or feed the straps through to loosen, depending on fit required (a). To adjust in the centre pull the D ring from the Velcro and feed strap through buckle on either strap to loosen the belt or pull D ring away from the buckle to tighten the belt (b).



Ensure strap is fed through the triglide as a safety precaution in case the camlock is opened accidentally.

9.2 Hip laterals

To adjust the width of the hip laterals loosen the knob (a) adjust to the required width and retighten.

To adjust the depth, loosen the two allen bolts (b) with the multi tool provided, adjust to the required depth and retighten the allen bolts.

The angle of the hip laterals can be adjusted by loosening allen bolt (c), adjusting to the required angle and retightening the bolt.



9.3 Backrest height

The overall height of the backrest can be adjusted by loosening the two knobs, then positioning to the shoulder height of the user. Once in position the knobs should be retightened securely. The height can be fine tuned when the user is in the seat. When the height is lowered the cushion must be pulled around the bottom of the backrest and secured to the back of it via the Velcro and elastic tabs.



Use caution when adjusting to minimum setting as fingers could become trapped between moving and static parts.



9.4 Backrest angle

The backrest can be angled by loosening the bolt (a) using a multi tool. Select the position you require then retighten the bolt securely. Always ensure the back angle is secure to maintain the desired posture for the child.

The backrest angle can be adjusted with the child in the seat, but always support the backrest with one hand.



Always make sure the bolt is secure as this could cause injury to the child or carer.

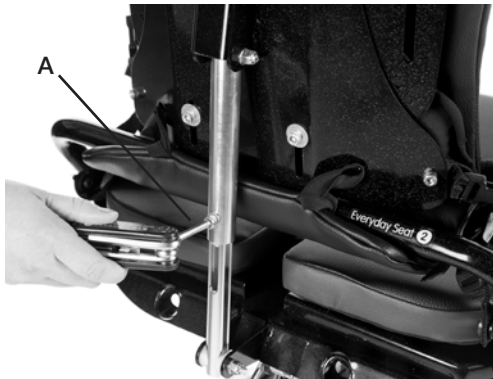

9.5 Seat depth

To adjust the seat depth simply loosen the knobs (a) on the underside of the seat base, pull the seat base towards you until the required seat depth has been achieved and tighten the knobs securely.

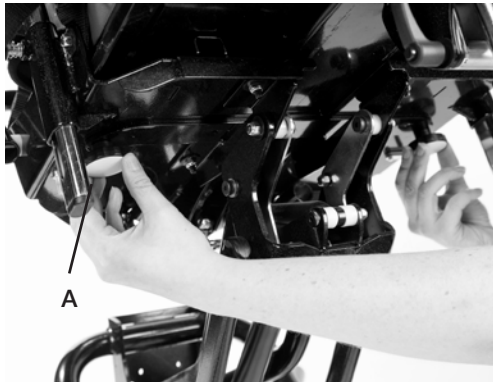

9.6 Footplate height

To set the height of Size 1 and 2 footplate, loosen the bolt (a) on the front of the calf support tube and slide the footplate to the required height and retighten the bolt. For Size 3, loosen the bolts on the sides of each calf support (b). Slide the footplate to the required height and retighten the bolt.



Always check the footplate is secure to prevent the user sliding forward and down in the seat which could pose a choking hazard if a chest or trunk harness is attached.

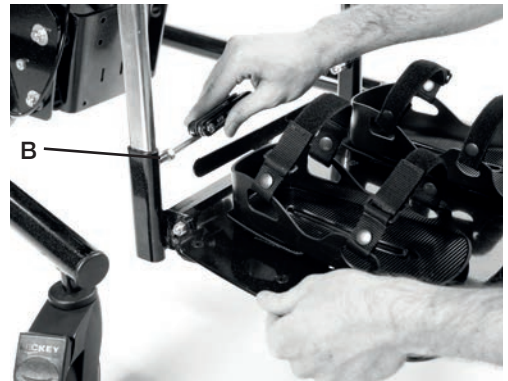
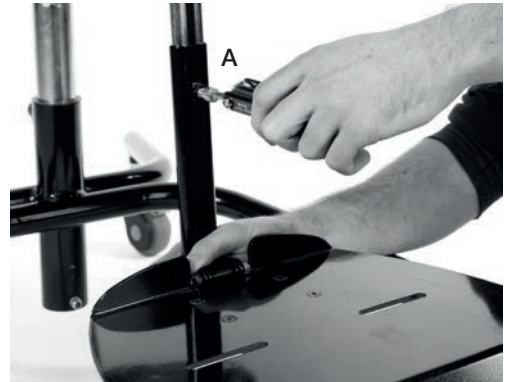

9.7 Footplate angle

To set the angle of the Size 1 and 2 footplate, loosen the ratchet handle (a) set to the required angle and retighten the handle. For Size 3 loosen the bolt (b), set to the required angle and retighten the bolt.



Always use caution to ensure fingers do not become trapped when adjusting the angle.

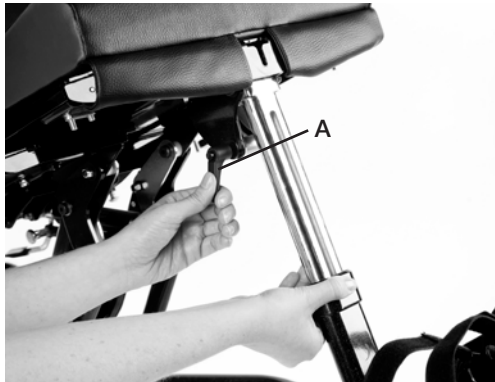

9.8 Sacral support

To adjust the height, loosen the bolts on either side with the multi tool provided. Adjust the support to the correct height and retighten the bolts.



Always use caution to ensure fingers do not become trapped when adjusting the sacral support.



9.9 Chest lateral supports

Loosen the allen bolts (a) to adjust the width, height and angle of the lateral supports and retighten when you have achieved the desired position.

To move the flipaway laterals, use knob (b).

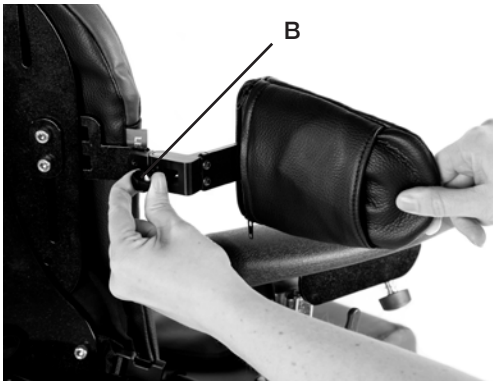

9.10 Chest harness

To change the width of the chest harness, lift the front cover, adjust the Velcro straps to the desired width and replace the cover.



9.11 Trunk Harness

The trunk harness will be open but remain attached by side clip (a). When placing the child in the seating system bring the trunk harness across the front and attach by connecting the clip into the buckle on the other side (b). All of the connecting straps are adjustable.

9.12 Sandals

To position the sandals simply loosen the knob under the footplate, select the position required and refasten the knob. To position the user's feet in the sandals secure the Velcro ankle straps provided.

A



B



9.13 Attaching the ankle huggers

Slide the webbing through the slot in the sandal. Loop the webbing back up and through the bottom of the triglide. Then pass the webbing through the top of the triglide. Finally to lock the webbing in place, pass it through the bottom of the triglide again. Trim strap to required length.



9.14 Shoulder support

To adjust the height of the shoulder support, loosen the allen bolts, move the shoulder support bracket to the required height and retighten the bolts.

9.15 Head support

To adjust the height and depth of the Size 1 and 2 head support, loosen the hand knobs (a) and when set to the required position retighten the knobs. Use the same method for Size 3 only use the ratchet handle instead of knob (b). Do not remove the head support while the user is in the seat.



Never use the head support to force the position of the user's head.



Always use caution to ensure fingers do not become trapped when adjusting the head support.

A



B



9.16 Armrest adjustment

To adjust the height of the armrest, loosen the hand knob (a), set to the desired height and retighten. To adjust the angle, rotate ratchet handle (b) until the desired position has been achieved.



9.17 Tray adjustment

The height and angle of the tray are set by adjusting the armrests as detailed in section 9.16. To remove or adjust the depth of the tray loosen the knobs (a) under the armrest, set to the desired position and retighten securely.



Always use caution to ensure the child's hands or arms do not become trapped when inserting the tray.



Never use the tray to steer or push the chair.



Do not place objects, hotter than 40 degrees Celsius on the tray.



Please note that the tray is for the use of the user only. Do not lean or place objects on the tray, greater than 8kgs (17.6lbs).

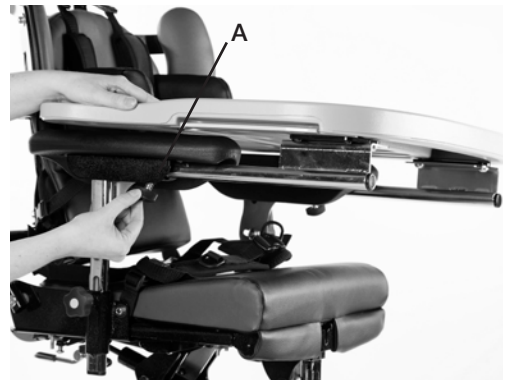

Frequent adjustment for daily use (therapists/ carers/parents)

Parents and carers should be shown how to make frequent adjustments and be made aware of the safety checks in Section 6 by a technically and clinically competent person who has been trained in the use of the product. Leckey recommend that a written record is maintained of all parents and carers who have been trained in the use of this product.

10

10.1 Transferring your child into and out of the seat

Before transferring the child into the seat carry out the daily product inspection as outlined in section 12 of this user manual.

Adjust the seat to a comfortable height to facilitate transfer. Lock all the castors, ensuring that they are facing outwards to maximise product stability. Make sure the safety buckle on the chest harness is released and is out of the way to facilitate transfer.

If the seat has flip-away chest laterals, first move these out of the way. Unclip the pelvic harness in the middle. Lastly if sandals are fitted, open the straps. You are now ready to transfer or hoist the child into the seat.

Once the child is in the seat, firstly fasten the pelvic harness using the middle buckle. Then refasten the sandal straps and any other harnesses, and reposition the chest laterals.



Always secure the pelvic harness or pelvic cradle first before fastening other buckles or harnesses. Adjust the harness so the child cannot slide or creep forward in the seat.

10.2 Adjusting the pelvic harness

For side adjustment, open the camlocks and either pull the straps to tighten or feed the straps through to loosen, depending on fit required (a). To adjust in the centre, pull the D ring from the Velcro and feed strap through buckle on either strap to loosen the belt or pull D ring away from the buckle to tighten the belt (b).



Ensure strap is fed through the triglide as a safety precaution in case the camlock is opened accidentally.

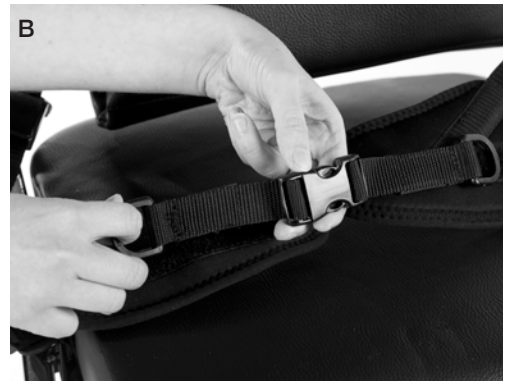

10.3 Chest and trunk harness adjustment

If the child requires chest support as part of their postural support programme the seat will be fitted with rigid laterals or a combination of laterals, chest harness and trunk harness. These may need to be adjusted on a daily basis to accommodate differences in clothing.

Always check with your therapist as to the optimum positioning and tensioning of the straps and support items for the child.

To change the width of the chest harness, lift the front cover, adjust the Velcro straps and set to the desired width. When the correct width has been achieved replace the cover.

Please refer to section 9.11 for specific guidance on adjusting the trunk harness. Always make sure the plastic buckles are fully engaged when using the chest harness.



Check the harness and laterals are secure to ensure the child is safe and cannot slide forward in the seat as this may restrict their breathing.



If the child is active or has extensor spasms check the pelvic harness is secure after each spasm to ensure the child is safe and cannot slide forward in the seat.



Always fasten the centre buckle on the pelvic harness before making any other adjustments.



10.4 Chassis

The Everyday Activity Seat is designed to fit onto several Chassis options. Size 1 fits onto a basic and hi-low gas spring chassis. Size 2 fits onto a basic, hi-low gas spring and hi-low powered chassis. Size 3 fits onto a basic and hi-low hydraulic chassis. This user manual shows the correct and safe use of the seating system with these chassis options. The castors on the chassis include directional locks. To apply the locks push down on the grey pedal. When the directional locks are in use the chair will steer with the back castors.

10.5 Height adjustment – Hi-low chassis

You can carry out this adjustment with the user in the chair. To adjust the height of the hi-low chassis press the foot lever at the rear of the chassis whilst holding the push handle. Once you remove your foot from the pedal the seat will be fixed at the chosen height. For safety the height adjustment pedal on the chassis can be locked by engaging the locking pin (a) on the right hand side of the pedal. To unlock pull the pin out and rotate 90 degrees, the pedal can then be operated. The locking pin (a) should be kept in the locked position when you are not adjusting the chassis.

Before using the foot pedal, pull the pedal out away from the seat.



Always keep the locking pin engaged when you are not adjusting the chassis. This will prevent the foot pedal being operated accidentally.



10.6 Height adjustment – Basic chassis



For children over the weight of 27kg (60lbs), raising the Hi-low chassis is a 2 person lift (UK lifting and handling regulations).



Always use caution as hands could become trapped when height adjusting the base.

The height of the Basic Chassis should be set before putting the child in the seat. To adjust the height loosen the ratchet handle (a) at the rear of the main stem and adjust the seat to the required height. To lower the seat height, apply weight centrally on the seat base above the centre stem. Retighten the ratchet handle to secure.



Check the ratchet handle regularly to ensure the seat height adjustment is secure.



Do not height adjust with the child in the seat.

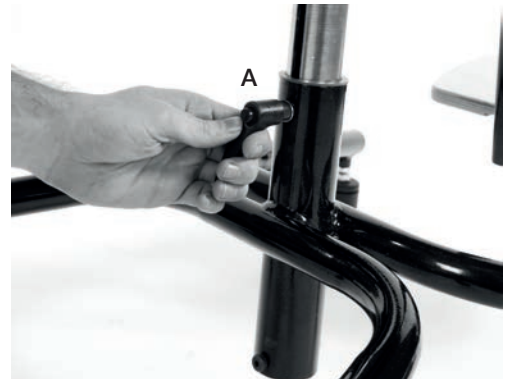
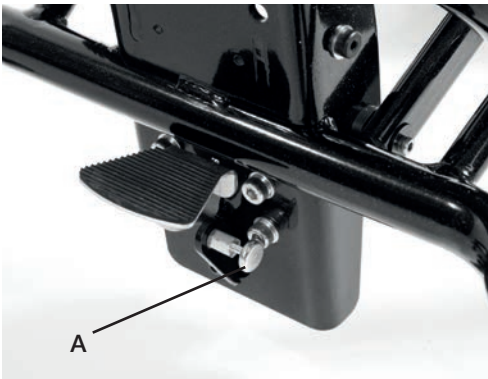

10.7 Height adjustment - Hi-Low Hydraulic Chassis

You can carry out this adjustment with the user in the chair. To adjust the height of the hi-low chassis use a pump action on the foot lever at the rear of the chassis whilst holding the push handle. Once you remove your foot from the pedal the seat will be fixed at the chosen height.

Before using the foot pedal, pull the pedal out away from the seat.

10.8 Height adjustment - Hi-Low Powered Chassis

You can carry out this adjustment with the user in the chair. Press the up or down arrowed button on the handset depending on height required. Hold the button in until required height is achieved. When you release the button the seat will be fixed at the chosen height.



10.9 Tilt-in-space

The tilt-in-space can be angled while the user is in the seat. Before you adjust the tilt-in-space angle of the seat always ensure the pelvic harness is secured preventing the user from sliding forward in the seat.

To adjust the tilt angle press the lever under the seat base. Once you have selected the angle you require, by simply removing your hand from the lever, the chair will be locked in position. The tilt-in-space should be locked off while the user is in the seat. To lock the lever twist the pull pin to the right hand side of the lever and the pin will pop into position. You may have to lift the lever slightly to allow it to lock.

To unlock, pull the pin out and rotate 90 degrees, the lever can then be operated.



Always keep the tilt-in-space lever in the locked position to prevent accidental actuation of the lever which could cause the seat unit to jolt and possibly cause injury to the child.



Please use handle bars when operating tilt in space.



Always check with your therapist that the use of tilt-in-space will not cause any obstructions to the child's airways.



Always keep a tight grip on handle bar with one hand when opening the lever.



10.10 Sandals

To position the user's feet in the sandals secure the Velcro straps provided so the foot is held in place. The straps should be placed over the bridge of the foot and over the toes.



If the child is wearing sandals or light footwear check the straps to make sure the webbing does not irritate the skin.

10.11 Tray adjustment

The tray can be used for a range of functions and its position can be fine tuned to suit the user and the activity whether it is for fun, education or feeding. To attach the grey, clear or black tray, insert the tray tubes through the centre of the armrests. To insert the wooden tray, insert the single tray tube into the centre of the right or left armrest depending on position required. Once the tray is located in position (clear, black, grey or wooden) the knob (a) should be tightened securely.

Adjust the armrests to set the height and angle of the tray.



Always use caution as fingers could become trapped in the slot when adjusting the height.



Always use caution to ensure the child's hands or arms do not become trapped when inserting the tray.



Never use the tray to steer or push the chair.



When the user is in the seat, always hold the single tray tube when removing the tray from the receiver. Ensure to continue to hold onto the tray until it is clear of the user and the seat.



10.12 Armrest adjustment



Do not place hot objects, greater than 40 degrees Celsius on the tray.



Please note that the tray is for the use of the user only. Do not lean or place heavy objects on the tray, not greater than 8kgs (17.6lbs).

To adjust the height of the armrest loosen the hand knob (a) set to the desired height and retighten. To adjust the angle rotate ratchet handle (b) until the desired position has been achieved.

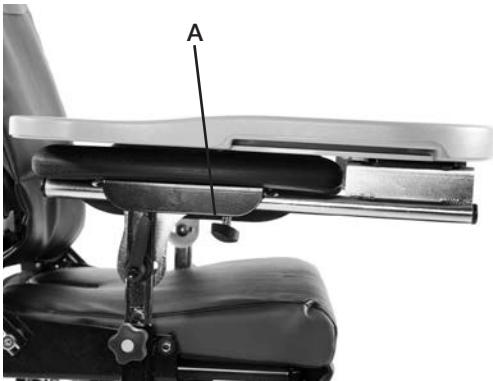

10.13 Using the Flip-Up Footplate

To raise the footplate, lift up from the front (a). When fully upright the pull pin will lock automatically. To lower the footplate pull the pull pin out (b) and push the footplate down. It is possible to keep the footplate unlocked by twisting the pull pin once you have pulled out.

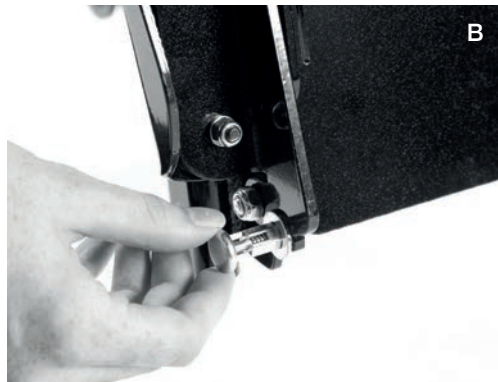

11 Cleaning & Care Information

How to Maintain

When cleaning we recommend that you use only warm water and a non-abrasive detergent. Never use organic solvents or dry cleaning fluids.

Upholstery and fabrics

1. The cushion covers in the soft fabric option can be removed and machine washed at 40°C however they are not suitable for tumble drying. Please remove the foam from the following covers before washing:

Headrest

Backrest cushion

Seat base cushion

All other soft upholstery can be placed into the washing machine intact, after removing bolts and fastenings.

The vinyl cushion covers can be cleaned using water and a cloth.

2. The upholstery and fabrics can also be cleaned by hand whilst in place. When cleaning we recommend that you use only warm water and a non-abrasive detergent.

3. Staining should be removed as quickly as possible with an absorbent cloth, towels or a sponge. Routine soap and warm water sponging is effective for ordinary soiling and minor spills. Be careful not to over wet the fabric as this will cause the staining to spread.

4. Antiseptic cleaning agents can be used on more stubborn stains. These may

require a safe solvent such as Isopropyl Alcohol or Mineral Spirit. A half cup of household bleach to 5 litres of water can also be used as a useful disinfectant.

5. The pelvic and trunk harnesses can be machine washed at 40 °C. Make sure all bolts and fasteners are removed first as they may cause damage to your washing machine. Store these in a safe place and out of reach from children.

6. Always ensure the product is dry before use.

Metal and plastic components

1. Soap and water or antibacterial spray can be used for daily cleaning.

2. For deep cleaning a low pressure steam cleaner can be used.

3. Do not use solvents to clean plastic or metal components.

4. Make sure the product is dry before use.

12 Daily Product Inspection

(Therapists, Parents & Carers)

We recommend that daily visual checks of the equipment are carried out by therapists, carers or parents to ensure the product is safe for use. The recommended daily checks are detailed below.

1. Ensure all adjustment knobs and bolts are in place and secure.
2. Check all upholstery and Velcro for signs of wear and tear.
3. Check all castors are moving freely and lock securely.
4. Ensure the handle and locking pin on the seat interface plate is fully engaged and the seat unit is securely fixed onto the chassis.
5. Ensure the pelvic harness is fully secured around the user and they cannot slide or creep forward in the seat.
6. Ensure the footplate is attached securely.



If in any doubt to the continued safe use of your Leckey product or if any parts should fail, please cease using the product and contact our Customer Care Team or your local dealer as soon as possible.

13 Annual Product Inspection

(Therapist, Technician, VIDA Product Specialist, Dealer)

Leckey recommend that each product should be subject to a detailed inspection at least once a year and every time the product is reissued for use. This inspection should be carried out by a technically competent person who has been trained in the use of the product and should include the following checks as a minimum requirement.

1. Check all ratchet handles, knobs, nuts, bolts and plastic buckles are in place, replacing any missing items. Paying particular attention to the following items:
 - > Head support locking bolts.
 - > Backrest height and angle adjustments bolts.
 - > Seat depth adjustment bolts.
 - > Pelvic harness / hip guide attachment bolts.
 - > Footrest height and angle adjustment.

2. Check the chassis height adjustment mechanism is working properly. If the chassis is foot pedal operated ensure the seat height doesn't change when the pedal is released. Also, check that the locking pin engages securely to prevent accidental height adjustment of the chassis.

3. Adjust the seat to its maximum range of tilt-in-space and ensure that the locking lever locks the seat out securely at varying points in this range.

4. Check that where the seat and chassis join there is no visible wear and tear on the metal components.

5. Lift the base to check each castor individually. Make sure they are moving freely and remove any dirt from the rubber wheels. Check that the brakes lock the wheels securely.

6. Visually check the structure of the product paying attention to weld points on the frame ensuring there are no signs of fatigue or cracking around the welds.

7. Leckey recommend that a written record is maintained of all annual product inspections.

If in any doubt to the continued safe use of your Leckey product or if any parts should fail, please cease using the product and contact our Customer Care Team or your local dealer as soon as possible.

13.1 Identification Label

The identification label is attached to the product and to the user manual. When ordering spare parts or making a claim, the following information is required:

- Serial number
- Date of Manufacture

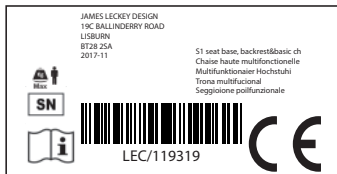

 Product name/item number

 Maximum weight

 CE Mark

 User Instructions

 Date of Manufacture

 Serial Number

14 Reissuing Leckey Products

Most Leckey products are assessed and ordered to meet the needs of an individual user. Before reissuing a product we recommend that the therapist prescribing the product has carried out an equipment compatibility check for the new user and has ensured that the product being reissued contains no modifications or special attachments.

A detailed technical inspection should be carried out on the product prior to reissuing. This should be carried out by a technically competent person who has been trained in the use and inspection of the product. Please refer to section 13 for the required checks to be carried out.

Ensure the product has been cleaned thoroughly in accordance with section 11 of this manual.

Ensure a copy of the user manual is supplied with the product. A copy can be downloaded from our website www.leckey.com

Leckey recommend that a written record is maintained of all product inspections

carried out during the reissue of the product.

If in any doubt to the continued safe use of your Leckey product or if any parts should fail, please cease using the product and contact our Customer Care Team or your local dealer as soon as possible.

15 Product Servicing

Servicing of all Leckey products should only be carried out by technically competent persons who have been trained in the use of the product.

All international service enquiries should be directed to the appropriate Leckey distributor who will be delighted to assist you. For further information on Leckey distributors please visit our website www.leckey.com

16 Technical Information

Size	1		2		3	
	mm/kg	inches/lbs	mm/kg	inches/lbs	mm/kg	inches/lbs
Maximum load	30kgs	66lbs	50kg	110lbs	100kgs	220lbs
Weight - seat and basic chassis	22.5kg	50lbs	27kg	60lbs	35.9kg	79lbs
Weight - seat and hi-low chassis	29.5kg	65lbs	34kg	75lbs	49kg	108lbs
Seat height – basic chassis	450-600	17.7-23.6	450-600	17.7-23.6	450-600	17.7-23.6
Seat height – hi-low chassis	250-600	9.8-23.6	320-600	12.6-23.6	450-600	17.7-23.6
Seat width	160-280	6.3-11	260-380	10.2-15	340-500	13.4-19.7
Seat depth	150-280	5.9-11	230-380	9-15	330-480	13-18.9
Lateral chest distance	150-220	5.9-8.7	170-240	6.7-9.4	240-370	9.4-14.6
Back height	300-400	11.8-15.7	400-520	15.7-20.5	450-630	17.7-24.8
Back angle	30° supine 10° prone		30° supine 10° prone		30° supine 10° prone	
Armrest height	150-250	5.9-9.8	200-300	7.9-11.8	180-325	7-12.7
Lower leg length	150-250	5.9-9.8	250-450	9.8-17.7	250-450	9.8-17.7
Lower leg angle	-10° to +50°		-10° to +50°		-10° to +50°	
Footplate angle	-15° to +10°		-15° to +10°		-15° to +10°	
Tilt-in-space	30° supine 10° prone		30° supine 10° prone		30° supine 10° prone	

All international service enquiries should be directed to the appropriate Leckey distributor who will be delighted to assist you. For further information on Leckey distributors please visit our website.

Accessories

CHASSIS

151-6100	Size 1 seat base, backrest and basic chassis with gas spring and 100mm castors -Black
151-6200	Size 2 seat base, backrest and basic chassis with gas spring and 100mm castors -Black
151-6300	Size 3 seat base, backrest and basic chassis with gas spring and 100mm castors -Black
151-6101	Size 1 seat base, backrest and basic chassis with gas spring 100mm castors -White
151-6201	Size 2 seat base, backrest and basic chassis with gas spring and 100mm castors -White
151-6301	Size 3 seat base, backrest and basic chassis with gas spring and 100mm castors -White
151-6102	Size 1 seat base, backrest and hi-low with gas spring and 100mm castors -Black
151-6202	Size 2 seat base, backrest and hi-low with gas spring and 100mm castors -Black
151-6103	Size 1 seat base, backrest and hi-low with gas spring and 100mm castors-White
151-6203	Size 2 seat base, backrest and hi-low with gas spring and 100mm castors-White
151-6204	Size 2 seat base, backrest and hi-low chassis powered 100mm castors -Black
151-6205	Size 2 seat base, backrest and hi-low chassis powered 100mm castors -White
151-6302	Size 3 seat base, backrest and a hydraulic chassis with 125mm castors -Black
151-6303	Size 3 seat base, backrest and a hydraulic chassis with 125mm castors -White

COVER PACKS

151-6104-01	Size 1 cushions and covers - Green Base (with sacral foam spacer pads)
151-6104-03	Size 1 cushions and covers - Blue Base (with sacral foam spacer pads)
151-6104-04	Size 1 cushions and covers - Raspberry Base (with sacral foam spacer pads)
151-6104-05	Size 1 cushions and covers -Ebony Grey Base (with sacral foam spacer pads)
151-6104-01VIN	Size 1 cushions and covers - Green base (with sacral foam spacer pads)

- 151-6104-03VIN Size 1 cushions and covers - Blue base (with sacral foam spacer pads)
- 151-6104-04VIN Size 1 cushions and covers - Raspberry base (with sacral foam spacer pads)
- 151-6104-07VIN Size 1 cushions and covers - Black base (with sacral foam spacer pads)
- 151-6206-01 Size 2 cushions and covers - Green base (with sacral foam spacer pads)
- 151-6206-03 Size 2 cushions and covers - Blue base (with sacral foam spacer pads)
- 151-6206-04 Size 2 cushions and covers - Raspberry base (with sacral foam spacer pads)
- 151-6206-05 Size 2 cushions and covers - Ebony Grey base (with sacral foam spacer pads)
- 151-6206-01VIN Size 2 cushions and covers - Green base (with sacral foam spacer pads)
- 151-6206-03VIN Size 2 cushions and covers - Blue base (with sacral foam spacer pads)
- 151-6206-04VIN Size 2 cushions and covers - Raspberry base (with sacral foam spacer pads)
- 151-6206-07VIN Size 2 cushions and covers - Black base (with sacral foam spacer pads)
- 151-6304-01 Size 3 cushions and covers - Green base (with sacral foam spacer pads)
- 151-6304-03 Size 3 cushions and covers - Blue base (with sacral foam spacer pads)
- 151-6304-04 Size 3 cushions and covers - Raspberry base (with sacral foam spacer pads)
- 151-6304-05 Size 3 cushions and covers - Ebony Grey base (with sacral foam spacer pads)
- 151-6304-01VIN Size 3 cushions and covers - Green base (with sacral foam spacer pads)
- 151-6304-03VIN Size 3 cushions and covers - Blue base (with sacral foam spacer pads)
- 151-6304-04VIN Size 3 cushions and covers - Raspberry base (with sacral foam spacer pads)
- 151-6304-07VIN Size 3 cushions and covers - Black base (with sacral foam spacer pads)

HEAD SUPPORT ACCESSORIES

- 151-3751-05 S3 Contoured Headrest -(black neoprene)
- 151-6208-05 Size 1/2 flat headrest hardware and cover -Ebony Grey (only available with 01,03 & 04 cushion packs)
- 151-6208-06 Size 1/2 flat headrest hardware and cover -Dove Grey (only available with 05 cushion pack)
- 151-6208-05VIN Size 1/2 flat headrest hardware and cover -Ebony Grey (only available with 01VIN, 07VIN & 04VIN cushion packs)

- 151-6208-07VIN Size 1/2 flat headrest hardware and cover -Black (only available with 03VIN cushion pack)
- 151-6209-05 Flat headrest lateral assembly and cover -Ebony Grey (only available with 01,03,04 cushion packs)
- 151-6209-06 Flat headrest lateral assembly and cover -Dove Grey (only available with 05 cushion packs)
- 151-6209-05VIN Flat headrest lateral assembly and cover -Ebony Grey (only available with 01VIN, 07VIN & 04VIN cushion packs)
- 151-6209-07VIN Flat headrest lateral assembly and cover -Black (only available with 03VIN cushion packs)
- 151-1756 Mygo headrest attachment bracket

CHEST SUPPORT ACCESSORIES

- 151-6106-01 S1 Rigid PU chest laterals pair (Green cover)-Black metalwork
- 151-6106-03 S1 Rigid PU chest laterals pair (Blue cover)-Black metalwork
- 151-6106-04 S1 Rigid PU chest laterals pair (Raspberry cover)-Black metalwork
- 151-6106-05 S1 Rigid PU chest laterals pair (Ebony Grey)-Black metalwork
- 151-6106-01VIN S1 Rigid PU chest laterals pair (Green cover)-Black metalwork
- 151-6106-03VIN S1 Rigid PU chest laterals pair (Blue cover)-Black metalwork
- 151-6106-04VIN S1 Rigid PU chest laterals pair (Raspberry cover)-Black metalwork
- 151-6106-07VIN S1 Rigid PU chest laterals pair (Black cover)-Black metalwork
- 151-6107-01 S1 Rigid PU chest laterals pair (Green cover)-White metalwork
- 151-6107-03 S1 Rigid PU chest laterals pair (Blue cover)-White metalwork
- 151-6107-04 S1 Rigid PU chest laterals pair (Raspberry cover)-White metalwork
- 151-6107-05 S1 Rigid PU chest laterals pair (Ebony Grey cover)-White metalwork
- 151-6107-01VIN S1 Rigid PU chest laterals pair (Green cover)-White metalwork
- 151-6107-03VIN S1 Rigid PU chest laterals pair (Blue cover)-White metalwork
- 151-6107-04VIN S1 Rigid PU chest laterals pair (Raspberry cover)-White metalwork
- 151-6107-07VIN S1 Rigid PU chest laterals pair (Black cover)-White metalwork
- 151-6210-01 S2 Rigid PU chest laterals pair (Green cover)-Black metalwork
- 151-6210-03 S2 Rigid PU chest laterals pair (Blue cover)-Black metalwork
- 151-6210-04 S2 Rigid PU chest laterals pair (Raspberry cover)-Black metalwork
- 151-6210-05 S2 Rigid PU chest laterals pair (Ebony Grey cover)-Black metalwork
- 151-6210-01VIN S2 Rigid PU chest laterals pair (Green cover)-Black metalwork
- 151-6210-03VIN S2 Rigid PU chest laterals pair (Blue cover)-Black metalwork
- 151-6210-04VIN S2 Rigid PU chest laterals pair (Raspberry cover)-Black metalwork
- 151-6210-07VIN S2 Rigid PU chest laterals pair (Black cover)-Black metalwork
- 151-6211-01 S2 Rigid PU chest laterals pair (Green cover)-White metalwork

151-6211-03 S2 Rigid PU chest laterals pair (Blue cover)-White metalwork
 151-6211-04 S2 Rigid PU chest laterals pair (Raspberry cover)-White metalwork
 151-6211-05 S2 Rigid PU chest laterals pair (Ebony Grey cover)-White metalwork

151-6211-01VIN S2 Rigid PU chest laterals pair (Green cover)-White metalwork
 151-6211-03VIN S2 Rigid PU chest laterals pair (Blue cover)-White metalwork
 151-6211-04VIN S2 Rigid PU chest laterals pair (Raspberry cover)-White metalwork
 151-6211-07VIN S2 Rigid PU chest laterals pair (Black cover)-White metalwork

151-6306-01 S3 Rigid PU chest laterals pair (Green cover)-Black metalwork
 151-6306-03 S3 Rigid PU chest laterals pair (Blue cover)-Black metalwork
 151-6306-04 S3 Rigid PU chest laterals pair (Raspberry cover)-Black metalwork
 151-6306-05 S3 Rigid PU chest laterals pair (Ebony Grey cover)-Black metalwork

151-6306-01VIN S3 Rigid PU chest laterals pair (Green cover)-Black metalwork
 151-6306-03VIN S3 Rigid PU chest laterals pair (Blue cover)-Black metalwork
 151-6306-04VIN S3 Rigid PU chest laterals pair (Raspberry cover)-Black metalwork
 151-6306-07VIN S3 Rigid PU chest laterals pair (Black cover)-Black metalwork

151-6307-01 S3 Rigid PU chest laterals pair (Green cover)-White metalwork
 151-6307-03 S3 Rigid PU chest laterals pair (Blue cover)-White metalwork
 151-6307-04 S3 Rigid PU chest laterals pair (Raspberry cover)-White metalwork
 151-6307-05 S3 Rigid PU chest laterals pair (Ebony Grey cover)-White metalwork

151-6307-01VIN S3 Rigid PU chest laterals pair (Green cover)-White metalwork
 151-6307-03VIN S3 Rigid PU chest laterals pair (Blue cover)-White metalwork
 151-6307-04VIN S3 Rigid PU chest laterals pair (Raspberry cover)-White metalwork
 151-6307-07VIN S3 Rigid PU chest laterals pair (Black cover)-White metalwork

151-6108-01 S1 Flip away PU chest laterals pair (Green cover)-Black metalwork
 151-6108-03 S1 Flip away PU chest laterals pair (Blue cover)-Black metalwork
 151-6108-04 S1 Flip away PU chest laterals pair (Raspberry cover)-Black metalwork
 151-6108-05 S1 Flip away PU chest laterals pair (Ebony Grey cover)-Black
 metalwork

151-6108-01VIN S1 Flip away PU chest laterals pair (Green cover)-Black metalwork
 151-6108-03VIN S1 Flip away PU chest laterals pair (Blue cover)-Black metalwork
 151-6108-04VIN S1 Flip away PU chest laterals pair (Raspberry cover)-Black metalwork
 151-6108-07VIN S1 Flip away PU chest laterals pair (Black cover)-Black metalwork

151-6109-01 S1 Flip away PU chest laterals pair (Green cover)-White metalwork
 151-6109-03 S1 Flip away PU chest laterals pair (Blue cover)-White metalwork
 151-6109-04 S1 Flip away PU chest laterals pair (Raspberry cover)-White metalwork
 151-6109-05 S1 Flip away PU chest laterals pair (Ebony Grey cover)-White
 metalwork

151-6109-01VIN S1 Flip away PU chest laterals pair (Green cover)-White metalwork
 151-6109-03VIN S1 Flip away PU chest laterals pair (Blue cover)-White metalwork
 151-6109-04VIN S1 Flip away PU chest laterals pair (Raspberry cover)-White metalwork

151-6109-07VIN S1 Flip away PU chest laterals pair (Black cover)-White metalwork

151-6212-01 S2 Flip away PU chest laterals pair (Green cover)-Black metalwork

151-6212-03 S2 Flip away PU chest laterals pair (Blue cover)-Black metalwork

151-6212-04 S2 Flip away PU chest laterals pair (Raspberry cover)-Black metalwork

151-6212-05 S2 Flip away PU chest laterals pair (Ebony Grey cover)-Black metalwork

151-6212-01VIN S2 Flip away PU chest laterals pair (Green cover)-Black metalwork

151-6212-03VIN S2 Flip away PU chest laterals pair (Blue cover)-Black metalwork

151-6212-04VIN S2 Flip away PU chest laterals pair (Raspberry cover)-Black metalwork

151-6212-07VIN S2 Flip away PU chest laterals pair (Black cover)-Black metalwork

151-6213-01 S2 Flip away PU chest laterals pair (Green cover)-White metalwork

151-6213-03 S2 Flip away PU chest laterals pair (Blue cover)-White metalwork

151-6213-04 S2 Flip away PU chest laterals pair (Raspberry cover)-White metalwork

151-6213-05 S2 Flip away PU chest laterals pair (Ebony Grey cover)-White metalwork

151-6213-01VIN S2 Flip away PU chest laterals pair (Green cover)-White metalwork

151-6213-03VIN S2 Flip away PU chest laterals pair (Blue cover)-White metalwork

151-6213-04VIN S2 Flip away PU chest laterals pair (Raspberry cover)-White metalwork

151-6213-07VIN S2 Flip away PU chest laterals pair (Black cover)-White metalwork

151-6308-01 S3 Flip away PU chest laterals pair (Green cover)-Black metalwork

151-6308-03 S3 Flip away PU chest laterals pair (Blue cover)-Black metalwork

151-6308-04 S3 Flip away PU chest laterals pair (Raspberry cover)-Black metalwork

151-6308-05 S3 Flip away PU chest laterals pair (Ebony Grey cover)-Black metalwork

151-6308-01VIN S3 Flip away PU chest laterals pair (Green cover)-Black metalwork

151-6308-03VIN S3 Flip away PU chest laterals pair (Blue cover)-Black metalwork

151-6308-04VIN S3 Flip away PU chest laterals pair (Raspberry cover)-Black metalwork

151-6308-07VIN S3 Flip away PU chest laterals pair (Black cover)-Black metalwork

151-6309-01 S3 Flip away PU chest laterals pair (Green cover)-White metalwork

151-6309-03 S3 Flip away PU chest laterals pair (Blue cover)-White metalwork

151-6309-04 S3 Flip away PU chest laterals pair (Raspberry cover)-White metalwork

151-6309-05 S3 Flip away PU chest laterals pair (Ebony Grey cover)-White metalwork

151-6309-01VIN S3 Flip away PU chest laterals pair (Green cover)-White metalwork

151-6309-03VIN S3 Flip away PU chest laterals pair (Blue cover)-White metalwork

151-6309-04VIN S3 Flip away PU chest laterals pair (Raspberry cover)-White metalwork

151-6309-07VIN S3 Flip away PU chest laterals pair (Black cover)-White metalwork

151-6214-01 Size 1/2 Chest harness (Green cover included)

151-6214-03	Size 1/2 Chest harness (Blue cover included)
151-6214-04	Size 1/2 Chest harness (Raspberry cover included)
151-6214-05	Size 1/2 Chest harness (Ebony Grey cover included)
151-6214-01VIN	Size 1/2 Chest harness (Green cover included)
151-6214-03VIN	Size 1/2 Chest harness (Blue cover included)
151-6214-04VIN	Size 1/2 Chest harness (Raspberry cover included)
151-6214-07VIN	Size 1/2 Chest harness (Black cover included)
133-625	S3 Chest Harness (black neoprene)
151-1757	Size 1 Complex flipaway laterals pair - Black metalwork
151-2757	Size 2 Complex flipaway laterals pair - Black metalwork
151-3757	Size 3 Complex flipaway laterals pair - Black metalwork
151-6110	Size 1 Complex flipaway laterals pair - White metalwork
151-6215	Size 2 Complex flipaway laterals pair - White metalwork
151-6311	Size 3 Complex flipaway laterals pair - White metalwork
151-6111-01	Size 1 Basic laterals pair (Green cover included)-Black Metalwork
151-6111-03	Size 1 Basic laterals pair (Blue cover included)-Black Metalwork
151-6111-04	Size 1 Basic laterals pair (Raspberry cover included)-Black Metalwork
151-6111-05	Size 1 Basic laterals pair (Ebony Grey cover included)-Black Metalwork
151-6111-01VIN	Size 1 Basic laterals pair (Green cover included)-Black Metalwork
151-6111-03VIN	Size 1 Basic laterals pair (Blue cover included)-Black Metalwork
151-6111-04VIN	Size 1 Basic laterals pair (Raspberry cover included)-Black Metalwork
151-6111-07VIN	Size 1 Basic laterals pair (Black cover included)-Black Metalwork
151-6112-01	Size 1 Basic laterals pair (Green cover included)-White Metalwork
151-6112-03	Size 1 Basic laterals pair (Blue cover included)-White Metalwork
151-6112-04	Size 1 Basic laterals pair (Raspberry cover included)-White Metalwork
151-6112-05	Size 1 Basic laterals pair (Ebony Grey cover included)-White Metalwork
151-6112-01VIN	Size 1 Basic laterals pair (Green cover included)-White Metalwork
151-6112-03VIN	Size 1 Basic laterals pair (Blue cover included)-White Metalwork
151-6112-04VIN	Size 1 Basic laterals pair (Raspberry cover included)-White Metalwork
151-6112-07VIN	Size 1 Basic laterals pair (Black cover included)-White Metalwork
151-6216-01	Size 2 Basic laterals pair (Green cover included)-Black Metalwork
151-6216-03	Size 2 Basic laterals pair (Blue cover included)-Black Metalwork
151-6216-04	Size 2 Basic laterals pair (Raspberry cover included)-Black Metalwork
151-6216-05	Size 2 Basic laterals pair (Ebony Grey cover included)-Black Metalwork
151-6216-01VIN	Size 2 Basic laterals pair (Green cover included)-Black Metalwork
151-6216-03VIN	Size 2 Basic laterals pair (Blue cover included)-Black Metalwork
151-6216-04VIN	Size 2 Basic laterals pair (Raspberry cover included)-Black Metalwork
151-6216-07VIN	Size 2 Basic laterals pair (Black cover included)-Black Metalwork

151-6217-01	Size 2 Basic laterals pair (Green cover included)-White Metalwork
151-6217-03	Size 2 Basic laterals pair (Blue cover included)-White Metalwork
151-6217-04	Size 2 Basic laterals pair (Raspberry cover included)-White Metalwork
151-6217-05	Size 2 Basic laterals pair (Ebony Grey cover included)-White Metalwork
151-6217-01VIN	Size 2 Basic laterals pair (Green cover included)-White Metalwork
151-6217-03VIN	Size 2 Basic laterals pair (Blue cover included)-White Metalwork
151-6217-04VIN	Size 2 Basic laterals pair (Raspberry cover included)-White Metalwork
151-6217-07VIN	Size 2 Basic laterals pair (Black cover included)-White Metalwork
151-6312-01	Size 3 Basic laterals pair (Green cover included)-Black Metalwork
151-6312-03	Size 3 Basic laterals pair (Blue cover included)-Black Metalwork
151-6312-04	Size 3 Basic laterals pair (Raspberry cover included)-Black Metalwork
151-6312-05	Size 3 Basic laterals pair (Ebony Grey cover included)-Black Metalwork
151-6312-01VIN	Size 3 Basic laterals pair (Green cover included)-Black Metalwork
151-6312-03VIN	Size 3 Basic laterals pair (Blue cover included)-Black Metalwork
151-6312-04VIN	Size 3 Basic laterals pair (Raspberry cover included)-Black Metalwork
151-6312-07VIN	Size 3 Basic laterals pair (Black cover included)-Black Metalwork
151-6313-01	Size 3 Basic laterals pair (Green cover included)-White Metalwork
151-6313-03	Size 3 Basic laterals pair (Blue cover included)-White Metalwork
151-6313-04	Size 3 Basic laterals pair (Raspberry cover included)-White Metalwork
151-6313-05	Size 3 Basic laterals pair (Ebony Grey cover included)-White Metalwork
151-6313-01VIN	Size 3 Basic laterals pair (Green cover included)-White Metalwork
151-6313-03VIN	Size 3 Basic laterals pair (Blue cover included)-White Metalwork
151-6313-04VIN	Size 3 Basic laterals pair (Raspberry cover included)-White Metalwork
151-6313-07VIN	Size 3 Basic laterals pair (Black cover included)-White Metalwork
151-6218-05 Metalwork	Size 1/2 Protraction pad pair (Ebony Grey cover included)-Black
151-6218-06	Size 1/2 Protraction pad pair (Dove cover included)-Black Metalwork
151-6218-05VIN Metalwork	Size 1/2 Protraction pad pair (Ebony Grey cover included)-Black
151-6218-07VIN	Size 1/2 Protraction pad pair (Black cover included)-Black Metalwork
151-6219-05 Metalwork	Size 1/2 Protraction pad pair (Ebony Grey cover included)-White
151-6219-06	Size 1/2 Protraction pad pair (Dove Grey cover included)-White Metalwork
151-6219-05VIN Metalwork	Size 1/2 Protraction pad pair (Ebony Grey cover included)-White
151-6219-07VIN	Size 1/2 Protraction pad pair (Black cover included)-White Metalwork
151-6314-05	Size 3 Protraction Pad pair (Ebony Grey cover included)-Black Metalwork
151-6314-06	Size 3 Protraction Pad pair (Dove Grey cover included)-Black Metalwork

151-6314-05VIN Size 3 Protraction Pad pair (Ebony Grey included)-Black Metalwork
 151-6314-07VIN Size 3 Protraction Pad pair (Black cover included)-Black Metalwork

 151-6315-05 Size 3 Protraction Pad pair (Ebony Grey cover included)-White Metalwork
 151-6315-06 Size 3 Protraction Pad pair (Dove Grey cover included)-White Metalwork

 151-6315-05VIN Size 3 Protraction Pad pair (Ebony Grey included)-White Metalwork
 151-6315-07VIN Size 3 Protraction Pad pair (Black cover included)-White Metalwork

 151-1754 Size 1 side pad (Pair-hardware only) -Black metalwork
 151-2754 Size 2 side pad (Pair-hardware only) -Black metalwork
 151-3754 Size 3 side pad (Pair-hardware only) -Black metalwork

 151-6113 Size 1 side pad (Pair-hardware only) -White metalwork
 151-6220 Size 2 side pad (Pair-hardware only) -White metalwork
 151-6316 Size 3 side pad (Pair-hardware only) -White metalwork

 151-6114-01 Size 1 side pads cover pair (Green)
 151-6114-03 Size 1 side pads cover pair (Blue)
 151-6114-04 Size 1 side pads cover pair (Raspberry)
 151-6114-05 Size 1 side pads cover pair (Ebony Grey)

 151-6114-01VIN Size 1 side pads cover pair (Green)
 151-6114-03VIN Size 1 side pads cover pair (Blue)
 151-6114-04VIN Size 1 side pads cover pair (Raspberry)
 151-6114-07VIN Size 1 side pads cover pair (Black)

 151-6221-01 Size 2 side pads cover pair (Green)
 151-6221-03 Size 2 side pads cover pair (Blue)
 151-6221-04 Size 2 side pads cover pair (Raspberry)
 151-6221-05 Size 2 side pads cover pair (Ebony Grey)

 151-6221-01VIN Size 2 side pads cover pair (Green)
 151-6221-03VIN Size 2 side pads cover pair (Blue)
 151-6221-04VIN Size 2 side pads cover pair (Raspberry)
 151-6221-07VIN Size 2 side pads cover pair (Black)

 151-6316-01 Size 3 side pads cover pair (Green)
 151-6316-03 Size 3 side pads cover pair (Blue)
 151-6316-04 Size 3 side pads cover pair (Raspberry)
 151-6316-05 Size 3 side pads cover pair (Ebony Grey)

 151-6316-01VIN Size 3 side pads cover pair (Green)
 151-6316-03VIN Size 3 side pads cover pair (Blue)
 151-6316-04VIN Size 3 side pads cover pair (Raspberry)
 151-6316-07VIN Size 3 side pads cover pair (Black)

 151-6115-01 Size 1 side pads pair (Green cover included)-Black Metalwork
 151-6115-03 Size 1 side pads pair (Blue cover included)-Black Metalwork

151-6115-04 Size 1 side pads pair (Raspberry cover included)-Black Metalwork
 151-6115-05 Size 1 side pads pair (Ebony Grey cover included)-Black Metalwork

 151-6115-01VIN Size 1 side pads pair (Green cover included)-Black Metalwork
 151-6115-03VIN Size 1 side pads pair (Blue cover included)-Black Metalwork
 151-6115-04VIN Size 1 side pads pair (Raspberry cover included)-Black Metalwork
 151-6115-07VIN Size 1 side pads pair (Black cover included)-Black Metalwork

 151-6116-01 Size 1 side pads pair (Green cover included)-White Metalwork
 151-6116-03 Size 1 side pads pair (Blue cover included)-White Metalwork
 151-6116-04 Size 1 side pads pair (Raspberry cover included)-White Metalwork
 151-6116-05 Size 1 side pads pair (Ebony Grey cover included)-White Metalwork

 151-6116-01VIN Size 1 side pads pair (Green cover included)-White Metalwork
 151-6116-03VIN Size 1 side pads pair (Blue cover included)-White Metalwork
 151-6116-04VIN Size 1 side pads pair (Raspberry cover included)-White Metalwork
 151-6116-07VIN Size 1 side pads pair (Black cover included)-White Metalwork

 151-6222-01 Size 2 side pads pair (Green cover included)-Black Metalwork
 151-6222-03 Size 2 side pads pair (Blue cover included)-Black Metalwork
 151-6222-04 Size 2 side pads pair (Raspberry cover included)-Black Metalwork
 151-6222-05 Size 2 side pads pair (Ebony Grey cover included)-Black Metalwork

 151-6222-01VIN Size 2 side pads pair (Green cover included)-Black Metalwork
 151-6222-03VIN Size 2 side pads pair (Blue cover included)-Black Metalwork
 151-6222-04VIN Size 2 side pads pair (Raspberry cover included)-Black Metalwork
 151-6222-07VIN Size 2 side pads pair (Black cover included)-Black Metalwork

 151-6223-01 Size 2 side pads pair (Green cover included)-White Metalwork
 151-6223-03 Size 2 side pads pair (Blue cover included)-White Metalwork
 151-6223-04 Size 2 side pads pair (Raspberry cover included)-White Metalwork
 151-6223-05 Size 2 side pads pair (Ebony Grey cover included)-White Metalwork

 151-6223-01VIN Size 2 side pads pair (Green cover included)-White Metalwork
 151-6223-03VIN Size 2 side pads pair (Blue cover included)-White Metalwork
 151-6223-04VIN Size 2 side pads pair (Raspberry cover included)-White Metalwork
 151-6223-07VIN Size 2 side pads pair (Black cover included)-White Metalwork

 151-6317-01 Size 3 side pads pair (Green cover included)-Black Metalwork
 151-6317-03 Size 3 side pads pair (Blue cover included)-Black Metalwork
 151-6317-04 Size 3 side pads pair (Raspberry cover included)-Black Metalwork
 151-6317-05 Size 3 side pads pair (Ebony Grey cover included)-Black Metalwork

 151-6317-01VIN Size 3 side pads pair (Green cover included)-Black Metalwork
 151-6317-03VIN Size 3 side pads pair (Blue cover included)-Black Metalwork
 151-6317-04VIN Size 3 side pads pair (Raspberry cover included)-Black Metalwork
 151-6317-07VIN Size 3 side pads pair (Black cover included)-Black Metalwork

151-6318-01	Size 3 side pads pair (Green cover included)-White Metalwork
151-6318-03	Size 3 side pads pair (Blue cover included)-White Metalwork
151-6318-04	Size 3 side pads pair (Raspberry cover included)-White Metalwork
151-6318-05	Size 3 side pads pair (Ebony Grey cover included)-White Metalwork
151-6318-01VIN	Size 3 side pads pair (Green cover included)-White Metalwork
151-6318-03VIN	Size 3 side pads pair (Blue cover included)-White Metalwork
151-6318-04VIN	Size 3 side pads pair (Raspberry cover included)-White Metalwork
151-6318-07VIN	Size 3 side pads pair (Black cover included)-White Metalwork
151-6224-01	Size 2 Abduction Side Pad (Green cover included)-Black metalwork
151-6224-03	Size 2 Abduction Side Pad (Blue cover included)-Black Metalwork
151-6224-04	Size 2 Abduction Side Pad (Raspberry cover included)-Black Metalwork
151-6224-05	Size 2 Abduction Side Pad (Ebony Grey cover included)-Black Metalwork
151-6224-01VIN	Size 2 Abduction Side Pad (Green cover included)-Black Metalwork
151-6224-03VIN	Size 2 Abduction Side Pad (Blue cover included)-Black Metalwork
151-6224-04VIN	Size 2 Abduction Side Pad (Raspberry cover included)-Black Metalwork
151-6224-07VIN	Size 2 Abduction Side Pad (Black cover included)-Black Metalwork
151-6225-01	Size 2 Abduction Side Pad (Green cover included)-White metalwork
151-6225-03	Size 2 Abduction Side Pad (Blue cover included)-White Metalwork
151-6225-04	Size 2 Abduction Side Pad (Raspberry cover included)-White Metalwork
151-6225-05	Size 2 Abduction Side Pad (Ebony Grey cover included)-White Metalwork
151-6225-01VIN	Size 2 Abduction Side Pad (Green cover included)-White Metalwork
151-6225-03VIN	Size 2 Abduction Side Pad (Blue cover included)-White Metalwork
151-6225-04VIN	Size 2 Abduction Side Pad (Raspberry cover included)-White Metalwork
151-6225-07VIN	Size 2 Abduction Side Pad (Black cover included)-White Metalwork
151-6320-01	Size 3 Abduction Side Pad (Green cover included)-Black Metalwork
151-6320-03	Size 3 Abduction Side Pad (Blue cover included)-Black Metalwork
151-6320-04	Size 3 Abduction Side Pad (Raspberry cover included)-Black Metalwork
151-6320-05	Size 3 Abduction Side Pad (Ebony Grey cover included)-Black Metalwork
151-6320-01VIN	Size 3 Abduction Side Pad (Green cover included)-Black Metalwork
151-6320-03VIN	Size 3 Abduction Side Pad (Blue cover included)-Black Metalwork
151-6320-04VIN	Size 3 Abduction Side Pad (Raspberry cover included)-Black Metalwork
151-6320-07VIN	Size 3 Abduction Side Pad (Black cover included)-Black Metalwork
151-6321-01	Size 3 Abduction Side Pad (Green cover included)-White Metalwork
151-6321-03	Size 3 Abduction Side Pad (Blue cover included)-White Metalwork
151-6321-04	Size 3 Abduction Side Pad (Raspberry cover included)-White Metalwork
151-6321-05	Size 3 Abduction Side Pad (Ebony Grey cover included)-White Metalwork
151-6321-01VIN	Size 3 Abduction Side Pad (Green cover included)-White Metalwork
151-6321-03VIN	Size 3 Abduction Side Pad (Blue cover included)-White Metalwork
151-6321-04VIN	Size 3 Abduction Side Pad (Raspberry cover included)-White Metalwork

151-6321-07VIN Size 3 Abduction Side Pad (Black cover included)-White Metalwork

155-H001-L600 H-Style Harness Small & Strap Kit (Leckey)
155-H001-L601 H-Style Harness Med & Strap Kit (Leckey)
155-H001-L602 H-Style Harness Large & Strap Kit (Leckey)
155-H001-L603 H-Style Harness Xlarge & Strap Kit (Leckey)
155-N001-L600 Narrow Harness Small & Strap Kit (Leckey)
155-N001-L601 Narrow Harness Med & Strap Kit (Leckey)
155-N001-L602 Narrow Harness Large & Strap Kit (Leckey)
155-N001-L603 Narrow Harness Xlarge & Strap Kit (Leckey)
155-N001-L604 Narrow Harness Xxlarge & Strap Kit (Leckey)

120-799 Small trunk harness (Mygo)

120-757 Medium trunk harness (Mygo)

117-761 Large trunk harness (Mygo)

117-750 Harness extension strap (10cm)

151-6122 S1 Tray Wooden Flipaway

151-6231 S2 Tray Wooden Flipaway

151-6326 S3 Tray Wooden Flipaway

151-1644 S1 Tray plastic

151-2644 S2 Tray plastic

133-2148 Tray assembly (extended armrest clear)

133-2149 Tray assembly (extended armrest black)

151-3766 Tray assembly clear (additional 20mm seat width)

151-3767 Tray assembly black (additional 20mm seat width)

HIP SUPPORT ACCESSORIES

151-1660 S1-4 point pelvic belt

151-2660 S2-4 point pelvic belt

151-3660 S3-4 point pelvic belt

FOOT SUPPORT ACCESSORIES

151-1745 S1 One piece footplate metal - Black

151-2745 S2 One piece footplate metal -Black

151-3745 S3 One piece footplate metal -Black

151-6123 S1 One piece footplate metal - White

151-6223 S2 One piece footplate metal -White

151-6327 S3 One piece footplate metal -White

151-1746 S1 One piece footplate wooden

151-6232 S2 One piece footplate wooden

151-3746 S3 One piece footplate wooden
151-6125 S1 One piece footplate wooden- White
151-6235 S2 One piece footplate wooden- White
151-6329 S3 One piece footplate wooden- White

152-1600 S1 Sandals including straps
152-2600 S2 Sandals including straps
152-3600 S3 Sandals including straps

151-1755 S1 Footplate straps
151-2755 S2 Footplate straps
151-3755 S3 Footplate straps

151-1760 1" SANDAL RAISER (1 OFF) S1&2
151-3760 1" SANDAL RAISER (1 OFF) S3

AH01 Pair of Small Ankle Huggers
AH02 Pair of Medium Ankle Huggers

OTHER ACCESSORIES

151-6117 Size 1 Armrest (Pair)
151-6226 Size 2 Armrest (Pair)
151-3747 Size 3 Armrest (Pair)
151-6124 Size 1 Armrest (Pair) White
151-6234 Size 2 Armrest (Pair) White
151-6328 Size 3 Armrest (Pair) White

151-6118-01 Size 1 Disc Pommel (Green)-Black Metalwork
151-6118-03 Size 1 Disc Pommel (Blue)-Black Metalwork
151-6118-04 Size 1 Disc Pommel (Raspberry)-Black Metalwork
151-6118-05 Size 1 Pommel Disc (Ebony Grey)-Black Metalwork

151-6118-01VIN Size 1 Disc Pommel (Green)-Black Metalwork
151-6118-03VIN Size 1 Disc Pommel (Blue)-Black Metalwork
151-6118-04VIN Size 1 Disc Pommel (Raspberry)-Black Metalwork
151-6118-07VIN Size 1 Pommel Disc (Black)-Black Metalwork

151-6119-01 Size 1 Disc Pommel (Green)-White Metalwork
151-6119-03 Size 1 Disc Pommel (Blue)-White Metalwork
151-6119-04 Size 1 Disc Pommel (Raspberry)-White Metalwork
151-6119-05 Size 1 Pommel Disc (Ebony Grey)-White Metalwork

151-6119-01VIN Size 1 Disc Pommel (Green)-White Metalwork
151-6119-03VIN Size 1 Disc Pommel (Blue)-White Metalwork
151-6119-04VIN Size 1 Disc Pommel (Raspberry)-White Metalwork
151-6119-07VIN Size 1 Pommel Disc (Black)-White Metalwork

151-6227-01	Size 2 Disc Pommel (Green)-Black Metalwork
151-6227-03	Size 2 Disc Pommel (Blue)-Black Metalwork
151-6227-04	Size 2 Disc Pommel (Raspberry)-Black Metalwork
151-6227-05	Size 2 Pommel Disc (Ebony Grey)-Black Metalwork
151-6227-01VIN	Size 2 Disc Pommel (Green)-Black Metalwork
151-6227-03VIN	Size 2 Disc Pommel (Blue)-Black Metalwork
151-6227-04VIN	Size 2 Disc Pommel (Raspberry)-Black Metalwork
151-6227-07VIN	Size 2 Pommel Disc (Black)-Black Metalwork
151-6228-01	Size 2 Disc Pommel (Green)-White Metalwork
151-6228-03	Size 2 Disc Pommel (Blue)-White Metalwork
151-6228-04	Size 2 Disc Pommel (Raspberry)-White Metalwork
151-6228-05	Size 2 Pommel Disc (Ebony Grey)-White Metalwork
151-6228-01VIN	Size 2 Disc Pommel (Green)-White Metalwork
151-6228-03VIN	Size 2 Disc Pommel (Blue)-White Metalwork
151-6228-04VIN	Size 2 Disc Pommel (Raspberry)-White Metalwork
151-6228-07VIN	Size 2 Pommel Disc (Black)-White Metalwork
151-6322-01	Size 3 Disc Pommel (Green)-Black Metalwork
151-6322-03	Size 3 Disc Pommel (Blue)-Black Metalwork
151-6322-04	Size 3 Disc Pommel (Raspberry)-Black Metalwork
151-6322-05	Size 3 Pommel Disc (Ebony Grey)-Black Metalwork
151-6322-01VIN	Size 3 Disc Pommel (Green)-Black Metalwork
151-6322-03VIN	Size 3 Disc Pommel (Blue)-Black Metalwork
151-6322-04VIN	Size 3 Disc Pommel (Raspberry)-Black Metalwork
151-6322-07VIN	Size 3 Pommel Disc (Black)-Black Metalwork
151-6323-01	Size 3 Disc Pommel (Green)-White Metalwork
151-6323-03	Size 3 Disc Pommel (Blue)-White Metalwork
151-6323-04	Size 3 Disc Pommel (Raspberry)-White Metalwork
151-6323-05	Size 3 Pommel Disc (Ebony Grey)-White Metalwork
151-6323-01VIN	Size 3 Disc Pommel (Green)-White Metalwork
151-6323-03VIN	Size 3 Disc Pommel (Blue)-White Metalwork
151-6323-04VIN	Size 3 Disc Pommel (Raspberry)-White Metalwork
151-6323-07VIN	Size 3 Pommel Disc (Black)-White Metalwork
151-6120-01	Wedge shape pommel S1 (Green)-Black Metalwork
151-6120-03	Wedge shape pommel S1 (Blue)-Black Metalwork
151-6120-04	Wedge shape pommel S1 (Raspberry)-Black Metalwork
151-6120-05	Wedge shape pommel S1 (Ebony Grey)-Black Metalwork
151-6120-01VIN	Wedge shape pommel S1 (Green)-Black Metalwork
151-6120-03VIN	Wedge shape pommel S1 (Blue)-Black Metalwork
151-6120-04VIN	Wedge shape pommel S1 (Raspberry)-Black Metalwork
151-6120-07VIN	Wedge shape pommel S1 (Black)-Black Metalwork

151-6121-01 Wedge shape pommel S1 (Green)-White Metalwork
151-6121-03 Wedge shape pommel S1 (Blue)-White Metalwork
151-6121-04 Wedge shape pommel S1 (Raspberry)-White Metalwork
151-6121-05 Wedge shape pommel S1 (Ebony Grey)-White Metalwork

151-6121-01VIN Wedge shape pommel S1 (Green)-White Metalwork
151-6121-03VIN Wedge shape pommel S1 (Blue)-White Metalwork
151-6121-04VIN Wedge shape pommel S1 (Raspberry)-White Metalwork
151-6121-07VIN Wedge shape pommel S1 (Black)-White Metalwork

151-6229-01 Wedge shape pommel S2 (Green)-Black Metalwork
151-6229-03 Wedge shape pommel S2 (Blue)-Black Metalwork
151-6229-04 Wedge shape pommel S2 (Raspberry)-Black Metalwork
151-6229-05 Wedge shape pommel S2 (Ebony Grey)-Black Metalwork

151-6229-01VIN Wedge shape pommel S2 (Green)-Black Metalwork
151-6229-03VIN Wedge shape pommel S2 (Blue)-Black Metalwork
151-6229-04VIN Wedge shape pommel S2 (Raspberry)-Black Metalwork
151-6229-07VIN Wedge shape pommel S2 (Black)-Black Metalwork

151-6230-01 Wedge shape pommel S2 (Green)-White Metalwork
151-6230-03 Wedge shape pommel S2 (Blue)-White Metalwork
151-6230-04 Wedge shape pommel S2 (Raspberry)-White Metalwork
151-6230-05 Wedge shape pommel S2 (Ebony Grey)-White Metalwork
151-6230-01VIN Wedge shape pommel S2 (Green)-White Metalwork
151-6230-03VIN Wedge shape pommel S2 (Blue)-White Metalwork
151-6230-04VIN Wedge shape pommel S2 (Raspberry)-White Metalwork
151-6230-07VIN Wedge shape pommel S2 (Black)-White Metalwork

151-6334-01 Wedge shape pommel S3 (Green)-Black Metalwork
151-6334-03 Wedge shape pommel S3 (Blue)-Black Metalwork
151-6334-04 Wedge shape pommel S3 (Raspberry)-Black Metalwork
151-6334-05 Wedge shape pommel S3 (Ebony Grey)-Black Metalwork

151-6334-01VIN Wedge shape pommel S3 (Green)-Black Metalwork
151-6334-03VIN Wedge shape pommel S3 (Blue)-Black Metalwork
151-6334-04VIN Wedge shape pommel S3 (Raspberry)-Black Metalwork
151-6334-07VIN Wedge shape pommel S3 (Black)-Black Metalwork

151-6335-01 Wedge shape pommel S3 (Green)-White Metalwork
151-6335-03 Wedge shape pommel S3 (Blue)-White Metalwork
151-6335-04 Wedge shape pommel S3 (Raspberry)-White Metalwork
151-6335-05 Wedge shape pommel S3 (Ebony Grey)-White Metalwork

151-6335-01VIN Wedge shape pommel S3 (Green)-White Metalwork
151-6335-03VIN Wedge shape pommel S3 (Blue)-White Metalwork
151-6335-04VIN Wedge shape pommel S3 (Raspberry)-White Metalwork
151-6335-07VIN Wedge shape pommel S3 (Black)-White Metalwork

151-6239 EDS swatch book

Distributed by:



Sunrise Medical Australia Pty. Ltd.

11 Daniel Street

Wetherill Park, NSW 2164

Phone: (02) 9678 6600

Email: enquiries@sunrisemedical.com.au Website:

www.SunriseMedical.com.au

Manufactured by:

LECKEY[®]

Leckey

19C Ballinderry Road, Lisburn, BT28 2SA

Northern Ireland, United Kingdom

Phone: +44 800 318265

Email: info@leckey.com

Website: www.leckey.com

24 hour postural
care for babies, kids
& adults.

Sleeping, Sitting,
Standing, Walking,
Moving, Bathing,
Toileting.



LS333-04