

QS 5x

OPTIONS AND ACCESSORIES CATALOGUE



Errors and omissions excepted - Information in this product brochure may contain unintentional errors or inaccuracies. All weights shown in this catalog are for reference only. They are calculated using Seat Width (SW) 400 mm/Seat Depth (SD) 420 mm dimensions. Please note that in practice the actual weight may vary from the theoretical weight due to variations in manufacturing tolerances and SW/SD dimensions. The information contained herein is based on our present knowledge and experience and is given in good faith. However, variations in weight are not grounds for a refund.

Seat Slings

Seat sling, nylon, 1 utility bag

Item Code: QSC020014

Standard nylon sling with a utility bag underneath - useful for storing belongings and compact tools.

350g



Seat cushion, cover with zipper, black

Foam (medium-soft), cover with zipper, black, 30 mm

Item Code: QSC020101

Simple foam cushion, available in 30 mm height (020101) and 50 mm height (020102).

625g

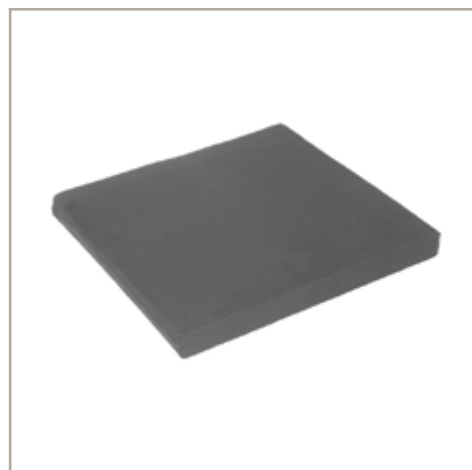

Seat cushion, cover with zipper, black

Foam (medium-soft), cover with zipper, black, 50 mm

Item Code: QSC020102

Simple foam cushion, available in 30 mm height (020101) and 50 mm height (020102).

870g

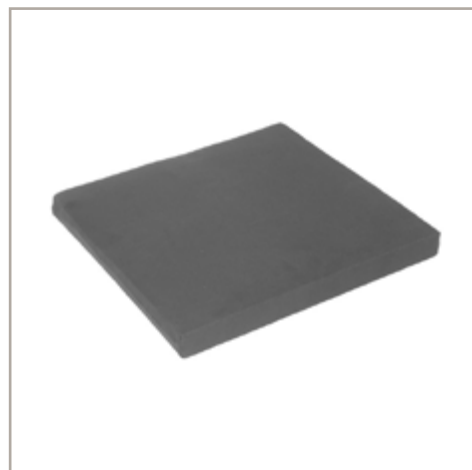

JAY Cushion

JAY Basic

Item Code: JAY020002

Mild contoured foam cushion, curved foam base for use with sling seat.

549,5g



JAY Cushion

JAY Soft Combi P

Item Code: JAY020003

Pre-contoured foam base with lateral and medial thigh support, incontinence resistant coated, easy-clean.

640,5g



JAY Cushion

JAY Easy Visco C

Item Code: JAY020001

Pre-contoured foam base with medial/lateral thigh support and a Visco elastic foam in the seat well for immersion of ischial tuberosities choice of curved or flat base.

985,5g



JAY Cushion

JAY Easy Fluid

Item Code: JAY020007

Pre-contoured foam base, built-in medial and lateral thigh support, choice of curved or flat base, JAY Flow fluid Tripad.

1750g



JAY Cushion

JAY Lite

Item Code: JAY020004

Perforated pre-contoured foam base that is extremely lightweight and breathable, ischial cut-outs and scooped foam in the pelvic loading area

735g



Seat accessories

Lap belt with buckle, metal

Item Code: QSC090018

Pelvic positioning belt, that can prevent sliding and falling out of the wheelchair.

250g



Backrest, fixed (90°)

Item Code: QSC030010

Most rigid backrest option due to fewer moving parts. This option should only be selected if the user is established and unlikely to change their upholstery. This option does not have angle adjustment for fine tuning or changing needs. Backrest tubes are perpendicular to the seat. (Weight is included in the basic chair weight)

0g

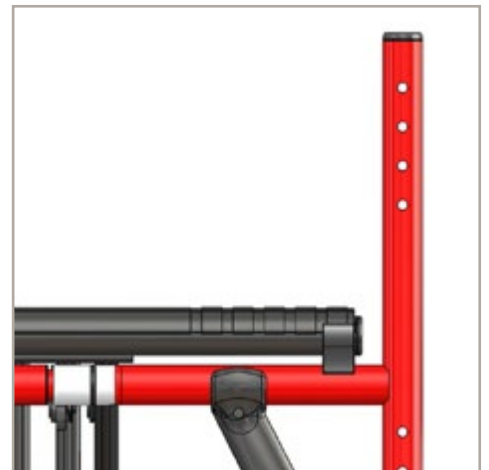

Lumbar curve 5° (to the front)

Item Code: QSC030111

Curve in the wheelchair backrest which supports the seated spinal curves to improve upright posture, functional reach, and wheelchair propulsion skills.

0g



Lumbar curve 5° (to the back)

Item Code: QSC030110

Curve in the wheelchair backrest which supports the seated spinal curves to improve upright posture, functional reach, and wheelchair propulsion skills.

0g



Backrest, half-folding (to the back)

Item Code: QSC030101

The half folding back (to the rear) allows the user or carers to fold down the backrest on a folding chair to reduce the overall package size for stowage. (Pair of weight)

360g



Backrest, fold-down (to the front)

Item Code: QSC030031

Backrests that fold forward are designed to reduce the height of your wheelchair to fit into everyday cars and to reduce the overall package size for stowage. (Pair of weight)

560g



Backrest, angle-adjustable

Item Code: QSC030012

Back angle is adjustable forwards and backwards, (range is dependant on the chair (see order form)) giving the ability to squeeze the client when a deep bucket is used or open the backrest for those with limited hip ROM. (Pair of weight)

650g



Push handles

Push handles, medium

Item Code: QSC030201

Standard handles provide optimal control when an attendant is pushing the chair but still keep the chair's overall length compact. (Pair of weight)

450g



Push handles

Push handles, long

Item Code: QSC030231

Standard handles provide optimal control when an attendant is pushing the chair but still keep the chair's overall length compact. (Pair of weight)

530g



Push handles

Push handles, fold-down

Item Code: QSC030203

The fold-down push handles may be used by pressing the button inside. Although they have less ease of grip than standard push handles, they are lightweight and have a discreet profile that nearly disappears when folded. (Pair of weight)

450g



Push handles

Push handles, height-adjustable

Item Code: QSC030204

Height adjustable push handles allow adjustment to a comfortable height that can be set independent of the backrest height. They can be dropped down and tucked away when not in use or be fully removed if they are no longer needed. (Pair of weight)

920g



Push handles

Push handles, height-adjustable for Jay backs

Item Code: QSC030205

Height adjustable push handles for JAY backrest. Use these if the chair also has a JAY backrest installed. These push handles can be utilized in combination with a low back height or short backrest to achieve desired push handle height for caregivers without interfering with the users propulsion. They can be dropped down and tucked away when not in use or be fully removed if they are no longer needed. (Pair of weight)

930g



Push handles

Without push handles

Item Code: QSC030200
(Pair of weight)

230g



Backrest upholstery

EXO Backrest sling, synthetic fibre, padded, adjustable, 1 accessory bag, black

Item Code: QSC030316

The EXO backrest is designed for both comfort and breathability. The ribbed curves allow for air to flow and the compressed EVA fabric ensures that it is both lightweight and comfortable.

645g



Backrest upholstery

EXO PRO Backrest, synthetic fibre, padded, adj., breathable, spacer fabric, 1 accessory bag, black

Item Code: QSC030317

The EXO PRO combines the features of the EXO upholstery with added 3DX spacer fabric technology providing additional comfort and extreme breathability.

645g



JAY Shape

JAY Shape Back

Item Code: JAY080001

Premium tension adjustable backrest for greater support and comfort. Available in short-height (400 mm) (JAY080001), medium-height (460 mm) (JAY080004), and tall-height (500 mm) (JAY080005).

1060g



JAY Shape

JAY SHAPE Lateral supports 10x12

Item Code: JAY080011

Provide support and accommodate spinal asymmetries, available in two sizes: 230x110 mm (030410) and 200x110 mm (030411) (Pair of weight)

580g



JAY Shape

JAY SHAPE Lateral supports 15x15 (Pair)

Item Code: JAY080010

Provide lateral support and accommodate spinal asymmetries, available in two sizes: 230x110 mm (030410) and 200x110 mm (030411) (Pair of weight)

750g



Backrest accessories

Stabilising bar, automatic folding

Item Code: QSC030402

The stabiliser bar provides extra rigidity to wider wheelchairs with upholstery rather than solid backrests. Folds up automatically when the chair is folded.

260g



Backrest accessories

Headrest, tall height, depth and angle-adjustable, 230 x 110 mm

Item Code: QSC030410

A headrest provides support and stability for the head and neck for individuals who have limited head and neck control. Available in tall height (030410) and medium height (030411)

1390g



Backrest accessories

**Headrest, medium height, depth&angle-adjustable,
200x110 mm**

Item Code: QSC030411

A headrest provides support and stability for the head and neck for individuals who have limited head and neck control. Available in tall height (030410) and medium height (030411)

1350g



JAY J3 Back - Shallow Contour Upper Thoracic - Short 420 mm

Item Code: JAY030012

The image shows option JAY030019 (460 mm).

2400g



JAY J3 Back - Shallow Contour Shoulder Height - Short 530 mm

Item Code: JAY030015

The image shows option JAY030019 (460 mm).

2650g



JAY J3 Back - Shallow Contour Mid Thoracic - Medium 340 mm

Item Code: JAY030010

The image shows option JAY030019 (460 mm).

1670g



JAY J3 Back - Shallow Contour Upper Thoracic - Medium 460 mm

Item Code: JAY030019

The image shows option JAY030019 (460 mm).

2520g



JAY J3 Back - Shallow Contour Shoulder Height - Medium 570 mm

Item Code: JAY030022

The image shows option JAY030019 (460 mm).

2760g



JAY J3 Back - Shallow Contour Mid Thoracic - Tall 380 mm

Item Code: JAY030033

The image shows option JAY030019 (460 mm).

1830g



JAY J3 Back - Shallow Contour Upper Thoracic - Tall 500 mm

Item Code: JAY030025

The image shows option JAY030019 (460 mm).

2620g



JAY J3 Back - Shallow Contour

Shoulder Height - Tall 610 mm

Item Code: JAY030028

The image shows option JAY030019 (460 mm).

2870g



JAY J3 Back - Mid Contour

Upper Thoracic - Short 420 mm

Item Code: JAY030013

The image shows option JAY030026 (500 mm).

2460g



JAY J3 Back - Mid Contour

Shoulder Height - Short 530 mm

Item Code: JAY030016

The image shows option JAY030026 (500 mm).

3420g



JAY J3 Back - Mid Contour

Mid Thoracic - Medium 340 mm

Item Code: JAY030011

The image shows option JAY030026 (500 mm).

2240g



JAY J3 Back - Mid Contour Upper Thoracic - Medium 460 mm

Item Code: JAY030020

The image shows option JAY030026 (500 mm).

2640g



JAY J3 Back - Mid Contour Shoulder Height - Medium 570 mm

Item Code: JAY030023

The image shows option JAY030026 (500 mm).

3560g



JAY J3 Back - Mid Contour Mid Thoracic - Tall 380 mm

Item Code: JAY030018

The image shows option JAY030026 (500 mm).

2340g



JAY J3 Back - Mid Contour Upper Thoracic- Tall 500 mm

Item Code: JAY030026

The image shows option JAY030026 (500 mm).

2680g



JAY J3 Back - Mid Contour

Shoulder Height - Tall 610 mm

Item Code: JAY030029

The image shows option JAY030026 (500 mm).

3710g



JAY J3 Back - Mid Deep Contour

(150 mm contour depth)

Upper Thoracic - Short 420 mm

Item Code: JAY030045

The image shows option JAY030042 (460 mm).

3120g



JAY J3 Back - Mid Deep Contour

(150 mm contour depth)

Shoulder Height - Short 530 mm

Item Code: JAY030043

The image shows option JAY030042 (460 mm).

3760g



JAY J3 Back - Mid Deep Contour

(150 mm contour depth)

Mid Thoracic - Medium 340 mm

Item Code: JAY030044

The image shows option JAY030042 (460 mm).

1650g



**JAY J3 Back - Mid Deep Contour
(150 mm contour depth)
Upper Thoracic - Medium 460 mm**

Item Code: JAY030042

The image shows option JAY030042 (460 mm).

3250g



**JAY J3 Back - Mid Deep Contour
(150 mm contour depth)
Shoulder Height - Medium 570 mm**

Item Code: JAY030047

The image shows option JAY030042 (460 mm).

3920g



**JAY J3 Back - Mid Deep Contour
(150 mm contour depth)
Mid Thoracic - Tall 380 mm**

Item Code: JAY030041

The image shows option JAY030042 (460 mm).

1720g



**JAY J3 Back - Mid Deep Contour
(150 mm contour depth)
Upper Thoracic - Tall 500 mm**

Item Code: JAY030046

The image shows option JAY030042 (460 mm).

3380g



**JAY J3 Back - Mid Deep Contour
(150 mm contour depth)
Shoulder Height - Tall 610 mm**

Item Code: JAY030048

The image shows option JAY030042 (460 mm).

4080g



**JAY J3 Back - Mid Deep Contour
(Extra Deep, 180 mm contour depth)
Upper Thoracic - Medium 570 mm**

Item Code: JAY030050

The image shows option JAY030050 (460 mm).

3970g



**JAY J3 Back - Mid Deep Contour
(Extra Deep, 180 mm contour depth)
Mid Thoracic - Tall 380 mm**

Item Code: JAY030049

The image shows option JAY030050 (460 mm).

2820g



**JAY J3 Back - Deep Contour
Upper Thoracic - Short 420 mm**

Item Code: JAY030014

The image shows option JAY030021 (460 mm).

2880g



JAY J3 Back - Deep Contour Shoulder Height - Short 530 mm

Item Code: JAY030017

The image shows option JAY030021 (460 mm).

3700g



JAY J3 Back - Deep Contour Upper Thoracic - Medium 460 mm

Item Code: JAY030021

The image shows option JAY030021 (460 mm).

3050g



JAY J3 Back - Deep Contour Shoulder Height - Medium 570 mm

Item Code: JAY030024

The image shows option JAY030021 (460 mm).

3860g



JAY J3 Back - Deep Contour Upper Thoracic - Tall 500 mm

Item Code: JAY030027

The image shows option JAY030021 (460 mm).

3140g



JAY J3 Back - Deep Contour

Shoulder Height - Tall 610 mm

Item Code: JAY030030

The image shows option JAY030021 (460 mm).

4020g



Whitmyer Headrest

Item Code: WHT030415

Cobra Xtra Flip Back Hardware - sleek, curved, and modular design with superior positioning capabilities, sizes ranging from early intervention to adult, and flip back function. Plush Pad - provides posterior support with a high degree of comfort and safety. This headrest is ideal for tilt or recline, accepts additional lateral and anterior supports, and is easily adjustable to adapt with clients as their needs change.

1534g



Whitmyer Headrest

Item Code: WHT030416

Axys hardware - durable, compact, one-size option with basic anterior-posterior adjustability at an outstanding value. Plush Pad - provides posterior support with a high degree of comfort and safety. This headrest is ideal for tilt or recline, accepts additional lateral and anterior supports, and is easily adjustable to adapt with clients as their needs change.

1522,5g



Armrest

Single-post sideguard, height-adjustable, removable, armpad (250 mm)

Item Code: QSC040050

Robust armrest solution, height-adjustable for increased comfort due to ideal armposition, choice of short (250 mm) (040050) and long (360 mm) armpads (040051), detachable for easier transport and less weight during transport. (Pair of weight)

1210g



Armrest

Single-post sideguard, height-adjustable, removable, armpad long (360 mm)

Item Code: QSC040051

Robust armrest solution, height-adjustable for increased comfort due to ideal armposition, choice of short (250 mm) (040050) and long (360 mm) armpads (040051), detachable for easier transport and less weight during transport. (Pair of weight)

1360g



Armrest

Single-post sideguard, armpad (330 mm), tool height-, depth-adjustable, removable

Item Code: QSC040052

Our lightest armrest offers the most support and protection with a built-in sideguard. It can be adjusted and moved forward/ backward, as well as being height adjustable. (Pair of weight)

920g



Desk armrest with long and short pad

Armpad for hemiplegic XL (length: 540 mm, width: 135 mm)

Item Code: QSC040144, QSC040145

Wide padded armrest offering particular support. Available in 2 different sizes, can be mounted right (040144) and left (040145).

1175g



Desk armrest with long and short pad

Armpad for hemiplegic (length: 460 mm, width: 105 mm)

Item Code: QSC040146, QSC040147

Wide padded armrest offering particular support. Available in 2 different sizes, can be mounted right (040146) and left (040147).

1440g



Desk armrest with long and short pad

Desk sideguard, flip-up, removable

Item Code: QSC040005

This armrest offers arm support with a built in side guard protection and flips away to allow transfers into the wheelchair. (Pair of weight)

1730g



Desk armrest with long and short pad

Desk sideguard, armpad (250 mm), fixed, flip-up, removable

Item Code: QSC040001

This armrest offers arm support with a built in side guard protection, arm pad lengths of 250 mm, the height of this armpad cannot be altered. (Pair of weight)

600g



Desk armrest with long and short pad

Desk sideguard, armpad (310 mm), fixed, flip-up, removable

Item Code: QSC040003

This armrest offers arm support with a built in side guard protection, arm pad lengths of 310 mm, the height of this armpad cannot be altered. (Pair of weight)

750g



Desk armrest with long and short pad

Desk sideguard, armpad (250 mm), height-adjustable, flip-up, removable

Item Code: QSC040002

This armrest offers arm support with a built in side guard protection, arm pad lengths of 250 mm, the height of this armpad can be altered. (Pair of weight)

700g



Desk sideguard, armpad (310 mm), height-adjustable, flip-up, removable

Item Code: QSC040004

This armrest offers arm support with a built in side guard protection, armpad lengths of 250 mm, the height of this armpad can be altered. (Pair of weight)

850g



Tubular armrest, Alu, swing away (sideways), padded, removable

Item Code: QSC040117

Armrest (composite side guards can be ordered separately). This style is detachable for side transfers and lowering transport weight. (Pair of weight)

1080g



Sideguards

Sideguard, composite, removable, 210 mm high (310 mm long), black

Item Code: QSC040107

Composite sideguards protect against dirt and moisture and keep the cushion in place. This style is detachable for side transfers and lowering transport weight. (Pair of weight)

860g



Sideguards

Sideguard, aluminium, cold weather protection (in frame colour)

Item Code: QSC040102

Aluminium sideguards protect against dirt and moisture and keep the cushion in place. Inner side has narrow foam for padding and cold weather protection. They are non removable. (Pair of weight)

750g



Sideguards

Sideguard, aluminium, cold weather protection, fender (in frame colour)

Item Code: QSC040103

Aluminium sideguards with fender provide the best protection against dirt and moisture and keep the cushion in place. Inner side has narrow foam for padding and cold weather protection. They are non removable. (Pair of weight)

880g



Sideguards

Sideguard, carbon fibre, fender, cold weather protection, black

Item Code: QSC040104

Ultra light weight and strong carbon sideguards protect against dirt and moisture and keep the cushion in place. Inner side has narrow foam for padding and cold weather protection. They are non removable. (Pair of weight)

480g



Slide on tray

Tray, push-fit, SB 380-480 mm

Item Code: QSC090011

Tray attachable to the wheelchairs, providing a firm table for eating, working, reading and other activities. Push fit mechanism.

2320g



Slide on tray

Tray Table, Half-Side, Swing Away

Item Code: QSC090046

The half side tray provides a large surface for upper limb support, particularly where there is upper limb weakness. It also can be used for reading and other activities, although it is not recommended for eating or drinking. It has an integrated swing-away mechanism for ease of transfer.

2660g



Swing away tray

Tray, swing-away (to the side), SW 340 - 600 mm

Item Code: QSC090012, QSC090013

Tray attachable to the wheelchairs, providing a firm table for eating, working, reading and other activities. Swing-away mechanism for easy transfer. Available with left-mount (090012) and right-mount (090013).

4340g



Frame FF 75 ° (integrated footrest) (EU: 105°)

Item Code: QSC010010

When selecting frame angle, lower extremity position is crucial. This depends on the angle of the lower leg support (e.g., hanger or front rigging) to support thighs and lower legs at the desired angle. Frame angle impacts length, turning radius, and the user's ability to approach objects. (Weight included in basic chair weight.)

0g



Frame FF 85 ° (integrated footrest) (EU: 95°)

Item Code: QSC010011

When selecting frame angle, lower extremity position is crucial. This depends on the angle of the lower leg support (e.g., hanger or front rigging) to support thighs and lower legs at the desired angle. Frame angle impacts length, turning radius, and the user's ability to approach objects. (Weight included in basic chair weight.)

0g



Frame FF 95 ° (integrated footrest), inset (20 mm on each side), active (EU95°)

Item Code: QSC010016

When selecting frame angle, lower extremity position is crucial. This depends on the angle of the lower leg support (e.g., hanger or front rigging) to support thighs and lower legs at the desired angle. Frame angle impacts length, turning radius, and the user's ability to approach objects. (Weight included in basic chair weight.)

0g



Frame SA (removable footrest)

Item Code: QSC010015

Swing-away footrests enhance accessibility and ease of use by allowing easy transfer in and out of the wheelchair and moving closer to objects. This is particularly beneficial for people with limited mobility or frequent transfers. Caregivers can also assist with transfers more comfortably. (Pair of weight)

870g



Frame Accessories

With crash test option (according to ISO 7176-19:2008)

Item Code: QSC090102

The crash test option is a feature that ensures that the wheelchair is compliant with ISO 7176-19 und 16840-4 safety standards related to transportation. This is needed for individuals who utilize their wheelchair for transport in a vehicle. (Pair of weight)

260g



Centre of gravity 25 mm, 40mm, 50mm, 60mm, 75mm

Item Code: COG25, COG40, COG50, COG60, COG75

The Center of Gravity (CoG) adjustment allows the user to adjust the balance point of the wheelchair to their specific needs, which can help improve stability, maneuverability, and overall comfort. (Is only an adjustment and therefore no weight)

0g

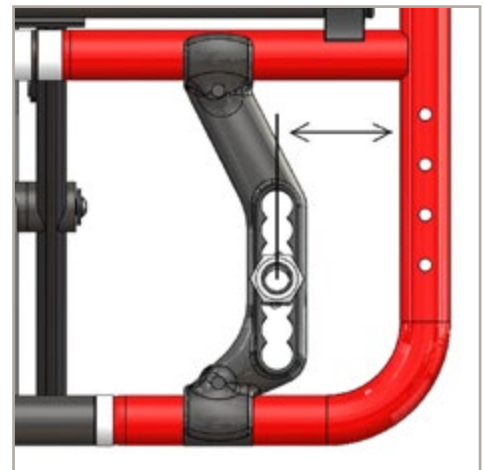

Transit wheels

Item Code: QSC090010

Transit wheels allow removal of rear wheels for short periods of time to access very narrow spaces, such as a very small doorway or aisle. Please note, the weight must be fully off the rear wheels for removal. (Pair of weight)

880g



Tip assist

Item Code: QSC090001, QSC090002, QSC090003

For carers to overcome kerbs easily. Available in left (090001), right (090002) and as pair (090003)

250g



Crutch Holder

Item Code: QSC090009

For carrying walking sticks or crutches.

125g



Anti-tip tubes, swing-away

Anti-tip tubes, swing-away

Item Code: QSC090004, QSC090005, QSC090006

Anti-tip tubes increase wheelchair safety by reducing the risk of rear tipping. Available in left (090004), right (090005) and pair (090006).

560g



Anti-tip tubes, swing-away

Anti-tip tubes, aluminium, lightweight, swing-away (forwards), pair

Item Code: QSC090036

Anti-tip tubes allow optimal driving performance (higher COG without safety risks), option with less weight impact. (Pair of weight)

920g



Twin-LED light

Item Code: QSC110156

Twin-LED light increases visibility and ensures that paths and roads are easier to see even in the dark. Increases visibility at night. (Pair of weight)

90g



Auto folding fixation

Item Code: QSC010056

Loading is a breeze with the automatic folding lock. Simply fold the wheelchair and load it. It stays folded thanks to the folding fixation.

90g



Touch points

Item Code: QSC010057

Frame parts covered with rubber where the chair is held whilst lifting for more grip and thus more ergonomic transportability. (Pair of weight)

130g



Aluminum & Composite hanger

Hanger angle 70°

Item Code: QSC050002

70° hanger angle for a more extended knee position where this is required for comfort or postural needs. (Pair of weight, aluminium hanger on image)

Aluminum = 605g ; Composite = 750g



Aluminum & Composite hanger

Hanger angle 80°

Item Code: QSC050001

80° hanger angle positions feet closer to wheelchair frame for a tighter turning circle and more support directly through the feet. (Pair of weight, aluminium hanger on image)

Aluminum = 595g ; Composite = 780g



Aluminum hanger

Hanger angle 90deg

Item Code: QSC050041

90° hanger angle positions feet closer to wheelchair frame for tightest turning circle and more support directly through the feet. (Pair of weight)

585g



Aluminum hanger

Hanger, aluminium, swing-away

Item Code: QSC050006, QSC050007

High performance aluminum hanger with swing-away mechanism for easier transfer, lightweight. Available in left (050006) and right (050007).

270g



Composite hanger

Hanger, composite, swing-away, left

Item Code: QSC050003

Composite hanger with swing-away mechanism for easier transfer, economic solution, low weight. Available in left (050003) and right (050004).

1050g



Elevating Legrest

Hanger, aluminium, flip-up (0° - 90°), swing-away

Item Code: QSC050009, QSC050010

Flip-up aluminum hanger with rigid aluminum housing. Easy operation, swing-away mechanism for easier transfer and durability (minimised wear & tear). Available with left-mount (050009) and right-mount (050010).

1179g



Amputee Support Pad

Amputee support

Item Code: QSC050012, QSC050013, QSC050014

This pad supports the amputated leg, this can be ordered as left (050014), right (050013) or pair (050012).

714g



Footplate

Footboard, divided, composite, flip-up (sideways), heel loop, black

Item Code: QSC050104

These footplates can be flipped-up to create space at the front of the wheelchair to transfer and have angle adjustment to accommodate the user. The depth can be adjusted slightly by swapping the footplates over. (Pair of weight)

540g



Footplate

Footboard, divided, composite, angle-adjustable, flip-up (sideways), heel loop, black

Item Code: QSC050020

Divided composite footboard, that is both angle and depth adjustable, and flips up sideways for easy transfer. Includes heel loop that can be utilized to assist with lower extremity positioning. (Pair of weight)

710g



Footplate

Footboard, divided, aluminum, angle-adjustable, flip-up (sideways), heel loop, black

Item Code: QSC050050

Divided footboard, made of aluminum, angle and depth adjustable, flip up sideways for easy transfer. (Pair of weight)

1820g



Footplate

Footboard, platform, aluminum, angle-adjustable, flip-up (sideways), heel loop, black

Item Code: QSC050102

Aluminum platform footboard, angle-adjustable for better positioning, flip-up (sideways) for easier transport, heel loop keeps foot in place.

840g



Footplate

Swing-away mechanism for platform footboard

Item Code: QSC050126

Swing-away mechanism for platform footboard.

50g



Footplate

Locking system, platform footplate, aluminium

Item Code: QSC050062

Locking mechanism in the middle for increased stability and to prevent unintended opening of the footboard. Unlocks for folding.

25g



Platform footrest, angle adjustable

Footboard, platform, lightweight, plastic, angle & depth-adj. flip up (sideways), calf strap, black

Item Code: QSC050131

Composite fibre footboard with angle and depth adjustment for full foot support.

740g



Platform footrest, angle adjustable

Footboard, platform, lightweight, carbon fibre, angle & depth-adj. flip up (sideways), calf strap, black

Item Code: QSC050132

Composite fibre footboard that flips up sideways with angle and depth adjustment for full foot support.

660g



Platform footrest, angle adjustable

Adjustable side protection, to create a side-stop on the footboard

Item Code: QSC050127

Lateral protection reduces risk of feet sliding sideways from the foot support.

40g



Autofolding

Footboard, platform, lightweight, carbon fibre, auto-folding, angle & depth-adj., calf strap, black

Item Code: QSC050027

Composite fibre footboard with angle and depth adjustment for full foot support. Auto-folds for easy folding.

715g



Autofolding

Footboard, platform, lightweight, plastic, auto-folding, angle & depth-adjustable, calf strap, black

Item Code: QSC050028

Composite fibre footboard with angle and depth adjustment for full foot support. Auto-folds for easy folding and provides rigidity compared to flip-back style.

765g



Castor fork, Aluminium, black (anodized)

Item Code: QSC080029

Castor fork, aluminium, black (anodized) (Pair of weight)

340g



Colour Cast. Fork Silver (anodized)

Item Code: QSC080042

Colour Cast. Fork Silver (anodized) (Pair of weight)

360g



Castor fork, Alumimium, Powder coated

Item Code: QSC080064

Castor fork aluminium powder coated (Pair of weight)

460g



Castor fork, Aluminium, One-arm

Item Code: QSC080008

Single arm forks decrease the front frame footprint slightly and adds an element of style to the front of the chair. (Pair of weight)

300g



**Fork
Expansion kit, designed for ultra-low seat heights**

Item Code: QSC080101

This kit allows ultra-low seat heights, which may be helpful for clients who need a low overall wheelchair height, foot propel or have hemiplegia. (Pair of weight)

600g



Castor, solid (hard), rim: composite, black

Item Code: QSC080301

Firm castor wheels have lower rolling resistance indoors. (Pair of weight)

4" = 502g ; 6" = 660g ; 7" = 1204g



Castor, solid (soft), rim: composite, black

Item Code: QSC080302

Width and softer material of these castor wheels provides better grip and rolling over pavements and other everyday outdoor surfaces but slightly more rolling resistance on smooth, flat surfaces. (Pair of weight)

5" = 823g ; 6" = 1138g



Castor, pneumatic, rim: composite, black**Item Code:** QSC080305

Pneumatic tires compensate for uneven ground better and offer a more cushioned ride. (Pair of weight)

5" = 582g ; 6" = 577g ; 7" = 868g

**Castor, solid (hard), rim: aluminium****Item Code:** QSC080304

Lower rolling resistance compared to soft solid casters, may be less comfortable on uneven terrain than soft solid casters. (Pair of weight)

4" = 343g ; 5" = 442g

**Castor, solid (soft), rim: aluminium, silver****Item Code:** QSC080306

Width and softer Poly-Urethan (PU) of these castor wheels provides better grip and rolling over pavements and other everyday outdoor surfaces but slightly more rolling resistance on smooth, flat surfaces. (Pair of weight)

4" = 428g ; 5" = 602g

**Rear wheel, Universal, 36 spokes (silver), cross-wise spokes****Item Code:** QSC070001

Robust, low-maintenance standard wheels suitable for heavy use and a variety of environments. (Pair of weight, weight specification for 24 inch)

1670g



Rear wheel, Design, 36 spokes (silver), straight spokes

Item Code: QSC070002

Appealing design with stylish, highly polished aluminium, radial spokes and low-profile wheel-hub. (Pair of weight, weight specification for 24 inch)

1586g



Rear wheel, Lightweight, 24 spokes (silver), straight spokes

Item Code: QSC070003

Appealing design with a reduced number of spokes for a discreet appearance. (Pair of weight, weight specification for 24 inch)

1222g



Rear wheel, Proton, 24 spokes (black), straight spokes

Item Code: QSC070004

These are our lightest wheels and feature a sleek look with black wheels and hub and proton branding. Due to their featherweight construction they have a lower user weight rating than other options (100kg weight-limit). (Pair of weight, weight specification for 24 inch)

1150g



Rear wheel, Spinergy, 18 spokes (black), straight spokes; hub: silver

Item Code: QSC070005

Made with a double-walled custom design aluminium rim for strength. Very little maintenance required. Available with 18 spokes (070005) or 12 spokes (070007). (Pair of weight, weight specification for 24 inch)

1390g



Rear wheel, Spinergy, 12 spokes (black), straight spokes, hub: black

Item Code: QSC070007

Made with a double-walled custom design aluminium rim for strength. Very little maintenance required. Available with 18 spokes (070005) or 12 spokes (070007). (Pair of weight, weight specification for 24 inch)

1320g



Rear wheel, drum brakes, 36 spokes (silver), cross-wise spokes

Item Code: QSC070008

This wheel option is compatible with our drum brake accessory. (Pair of weight, weight specification for 24 inch)

2020g



Rear wheel, Mountainbike, 36 spokes (silver), straight spokes

Item Code: QSC070009

This wheel comes complete with a mountain bike tyre ready for off road use. (Pair of weight, weight specification for 24 inch)

2420g



One-hand operation

Rear wheel, one-hand operation, 36 spokes, cross-spoked, left actuation

Item Code: QSC070401, QSC070402

Allows wheelchair to be pushed with one hand available with left (070401) or right actuation (070402). (Weight specification for 24 inch)

7250g



Tyre, pneumatic, fine profile, Schwalbe Right Run

Item Code: QSC070101

Classic fully pneumatic tyre for a cushioned ride and minimal rolling resistance. (Pair of weight, weight specification for 24 inch)

800g

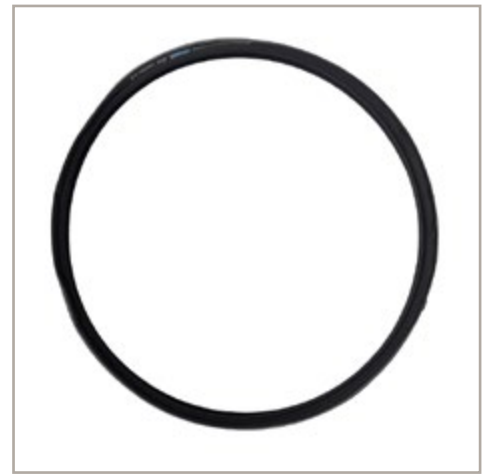

Tyre, puncture proof, tread

Item Code: QSC070102

The free solid tyre option provides the ultimate maintenance-free durability over the life of the tyre. Although these tyres won't go flat, they offer less cushioning and performance compared to pneumatic options. (Pair of weight, weight specification for 24 inch)

1150g



Tyre, pneumatic, slick, Schwalbe One

Item Code: QSC070107

This tyre features slick tread for manoevrability and lightweight pneumatic construction with a Kevlar liner to resist punctures. (Pair of weight, weight specification for 24 inch)

600g



Tyre, pneumatic, puncture proof, tread, Schwalbe Marathon Plus Evolution

Item Code: QSC070104

The extremely popular Marathon Plus Evolution provides a practical compromise between the flat prevention of a solid and the light, cushioned performance of a pneumatic tyre. It features a thick solid foam liner with an inner pneumatic section. (Pair of weight, weight specification for 24 inch)

1240g



Handrims, stainless steel, silver

Item Code: QSC070204

Durable stainless steel option that resists the appearance of scratches but is heavier than other handrim options. (Pair of weight, weight specification for 24 inch)

1370g



Handrims, aluminium, anodised, silver

Item Code: QSC070202

Classic lightweight aluminium handrim slides easily under the users hands and resists the appearance of scratches. (Pair of weight, weight specification for 24 inch)

610g



Handrims, aluminium, powder-coated, clear

Item Code: QSC070201

Classic lightweight aluminium handrim. Powder coating adds grip especially for users with impaired dexterity or hand function. (Pair of weight, weight specification for 24 inch)

690g



Handrims, aluminium, powder-coated, coloured

Item Code: QSC070203

Classic lightweight aluminium handrim with the option to colour match to your favourite colour. (Pair of weight, weight specification for 24 inch)

690g



Handrims, Supergrip ®

Item Code: QSC070207

This handrim has a rubberised grip that may be helpful for people with upper limb weakness or limited hand function, since it does not slide as easily as other handrim options when a user is slowing the wheelchair. (Pair of weight, weight specification for 24 inch)

1090g

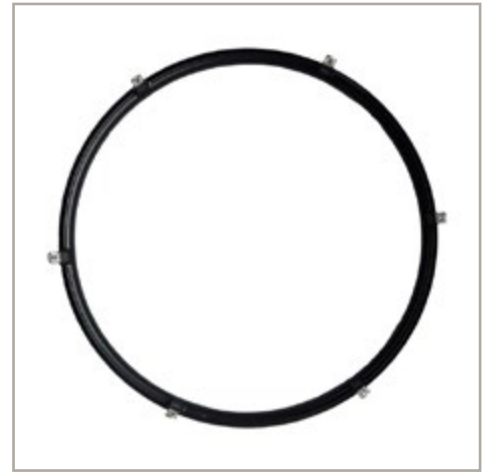

Handrims, Maxgrepp ®

Item Code: QSC070208

This option fills the gap between the handrim and wheel with a soft rubber making it easier to propel for those with less hand function. (Pair of weight, weight specification for 24 inch)

2440g



Handrims, Ellipse 3R, black

Item Code: QSC070212

Ellipse 3R handrims ensures pushing the wheelchair is easier. With its ergonomic curved shape and design, the Ellipse 3R mirrors the hand's natural shape for enhanced propelling. (Pair of weight, weight specification for 24 inch)

1270g



Handrim Mounting

Handrim mount, super narrow (7 mm), Handrim mount, narrow (17 mm), Handrim mount, wide (27 mm)

Item Code: QSC070307, QSC070317, QSC070327

17 mm (070317) is the standard setting that most users will be used to. It is also possible to have the handrim mounted closer at 7 mm (070307) and spaced out at 27 mm (070327). (Is only an adjustment and therefore no weight)

0g



Handrim cover, Silicon

Item Code: QSC070251

A rubber cover that is fitted over the handrim which can also be removed.
(Pair of weight, weight specification for 24 inch)

934g

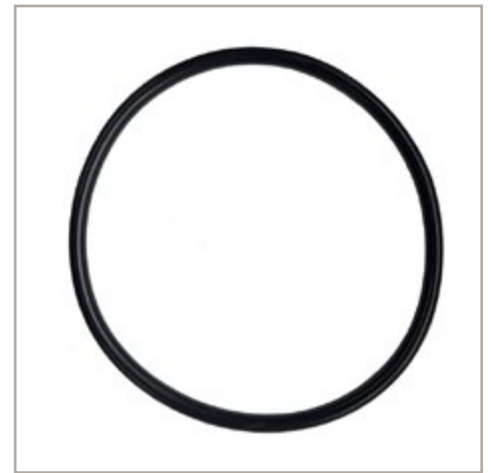

Camber 0°

Item Code: QSC070600

Camber is the angle of rear wheels in relation to the ground, typically at 90° (0 camber). Negative camber (e.g., in sports wheelchairs) angles the wheels inward, reducing force needed to maneuver and improving lateral stability due to increased wheel spacing. However, it may be harder to navigate narrow spaces. (Weight included in basic chair weight.)

0g



Camber 2°

Item Code: QSC070602

Camber is the angle of rear wheels in relation to the ground, typically at 90° (0 camber). Negative camber (e.g., in sports wheelchairs) angles the wheels inward, reducing force needed to maneuver and improving lateral stability due to increased wheel spacing. However, it may be harder to navigate narrow spaces. (Weight included in basic chair weight.)

0g



Camber 4°

Item Code: QSC070604

Camber is the angle of rear wheels in relation to the ground, typically at 90° (0 camber). Negative camber (e.g., in sports wheelchairs) angles the wheels inward, reducing force needed to maneuver and improving lateral stability due to increased wheel spacing. However, it may be harder to navigate narrow spaces. (Weight included in basic chair weight.)

0g



Basketball

Item Code: QSC070802

Spokeguards cover the rear wheel and thus protect against pinching fingers when accidentally coming into contact with the spokes of the wheels. The spokeguards come in large variety of designs. (Pair of weight)

780g



Basketball 2

Item Code: QSC070803

Spokeguards cover the rear wheel and thus protect against pinching fingers when accidentally coming into contact with the spokes of the wheels. The spokeguards come in large variety of designs. (Pair of weight)

780g



Chrome

Item Code: QSC070806

Spokeguards cover the rear wheel and thus protect against pinching fingers when accidentally coming into contact with the spokes of the wheels. The spokeguards come in large variety of designs. (Pair of weight)

780g



Feather

Item Code: QSC070811

Spokeguards cover the rear wheel and thus protect against pinching fingers when accidentally coming into contact with the spokes of the wheels. The spokeguards come in large variety of designs. (Pair of weight)

780g



Flying Water

Item Code: QSC070812

Spokeguards cover the rear wheel and thus protect against pinching fingers when accidentally coming into contact with the spokes of the wheels. The spokeguards come in large variety of designs. (Pair of weight)

780g

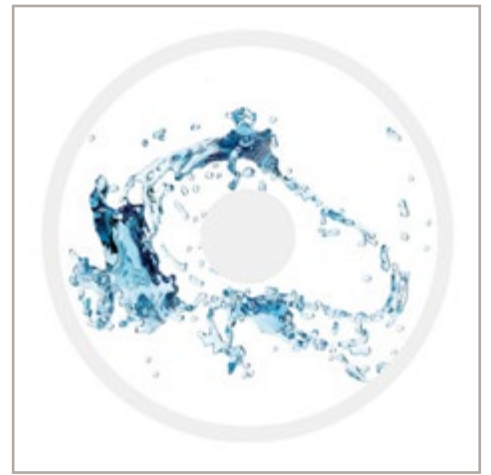

Graffiti

Item Code: QSC070814

Spokeguards cover the rear wheel and thus protect against pinching fingers when accidentally coming into contact with the spokes of the wheels. The spokeguards come in large variety of designs. (Pair of weight)

780g



Hot Wheels

Item Code: QSC070817

Spokeguards cover the rear wheel and thus protect against pinching fingers when accidentally coming into contact with the spokes of the wheels. The spokeguards come in large variety of designs. (Pair of weight)

780g



Oriental

Item Code: QSC070820

Spokeguards cover the rear wheel and thus protect against pinching fingers when accidentally coming into contact with the spokes of the wheels. The spokeguards come in large variety of designs. (Pair of weight)

780g



Pool

Item Code: QSC070822

Spokeguards cover the rear wheel and thus protect against pinching fingers when accidentally coming into contact with the spokes of the wheels. The spokeguards come in large variety of designs. (Pair of weight)

780g

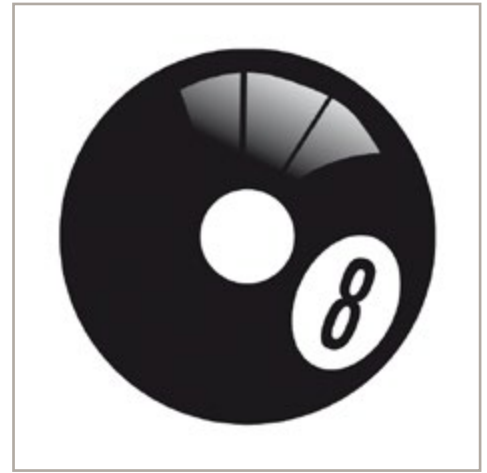

Silk

Item Code: QSC070827

Spokeguards cover the rear wheel and thus protect against pinching fingers when accidentally coming into contact with the spokes of the wheels. The spokeguards come in large variety of designs. (Pair of weight)

780g



Space

Item Code: QSC070828

Spokeguards cover the rear wheel and thus protect against pinching fingers when accidentally coming into contact with the spokes of the wheels. The spokeguards come in large variety of designs. (Pair of weight)

780g

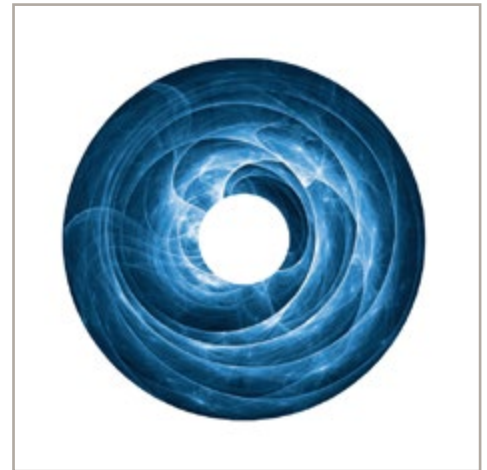

Transparent

Item Code: QSC070831

Spokeguards cover the rear wheel and thus protect against pinching fingers when accidentally coming into contact with the spokes of the wheels. The spokeguards come in large variety of designs. (Pair of weight)

780g

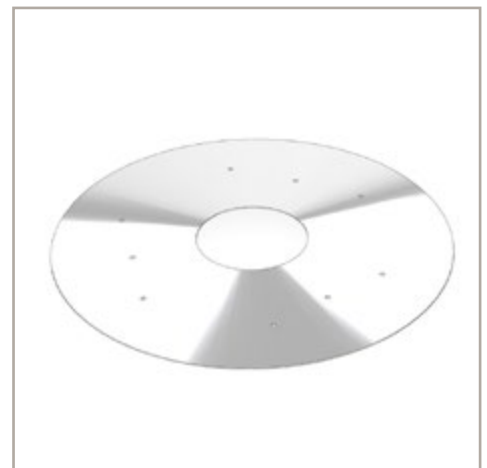

Standard brake

Item Code: QSC060001

Push to lock, spring loaded for ease of use, when engaged the lever lies out of the way making side transfers easy. (Pair of weight)

490g



Knee-lever brake

Item Code: QSC060002

Push to lock, lower forces to engage the brake, flip-down lever to prevent unintended opening by swing-away hangers and make room for transfers. (Pair of weight)

550g



Brake lever extension, knee-lever brake, fold-down

Item Code: QSC060010

This extension handle makes operating the knee lever wheel lock easier for users with restricted movement. (Pair of weight)

100g



Compact brake EVO

Item Code: QSC060023

This wheel lock is lightweight and low profile. It's out of the way for transfers but requires hand-function for engaging/ disengaging. (Pair of weight)

230g



Push to lock brake, one-arm

Item Code: QSC060015, QSC060016

Engaging one wheel lock also locks the opposite side via cable. This brake is suitable for those with difficulty in upper limb use on one side. Available for left (060015) and right (060016).

460g



Tool kit

Item Code: QSC090000

Contains the tools required for the adjustments available on the chair.

218,5g



Air pump

Item Code: QSC090025

A simple hand pump that can keep the tyre inflated to a reasonable pressure but is very difficult to reach the true pressure for the chair. Useful for the user to keep with them to keep punctures inflated while out and about until they can be repaired.

84g



High pressure pump (0 - 11 bar)

Item Code: QSC090024

Most of our pneumatic tyres are high pressure cycling tyres and can be pressurised up to 140 psi (please refer to the recommended amount on the tyre). The high pressure pump can fill the tyre to this level although some users may require assistance to do so.

1148g



Back pack

Item Code: QSC090030

Designed with special hoops to hang from the push handles or backposts of a wheelchair. Please keep your belongings secure.

541g



Mobile phone pocket

Item Code: QSC090026

Holds the mobile at the front of the chair.

52g





Sunrise Medical GmbH

Kahlbachring 2-4
69254 Malsch/HD
Tel.: +49 (0) 72 53 / 9 80-0
Fax: +49 (0) 72 53 / 9 80-222
E-Mail: international@sunrisemedical.de

For further information on the full specification, options, and accessories, please refer to the order form. All information is subject to change without notification. Please consult Sunrise Medical with any queries you may have.



If you are visually impaired, this document can be viewed in PDF format at www.SunriseMedical.eu.