

ASSEMBLY INSTRUCTION

# Stabilator Plug Gemino Carbon

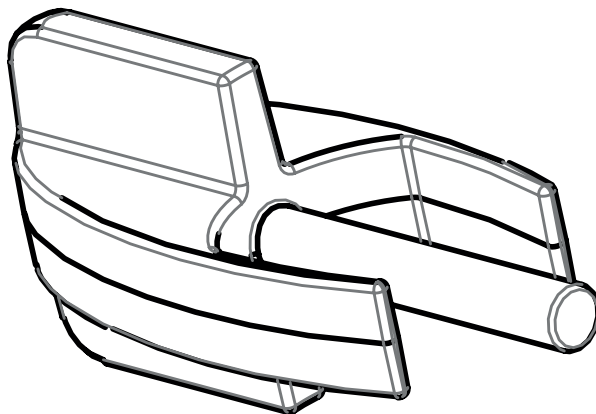

**Description**

Stabilator Plug Push Handle Gemino Carbon

**Article number**

71001700-ET

# GEMINO

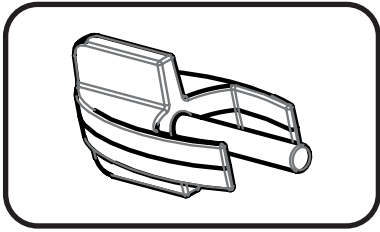
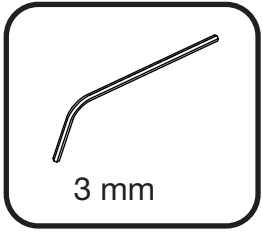

1

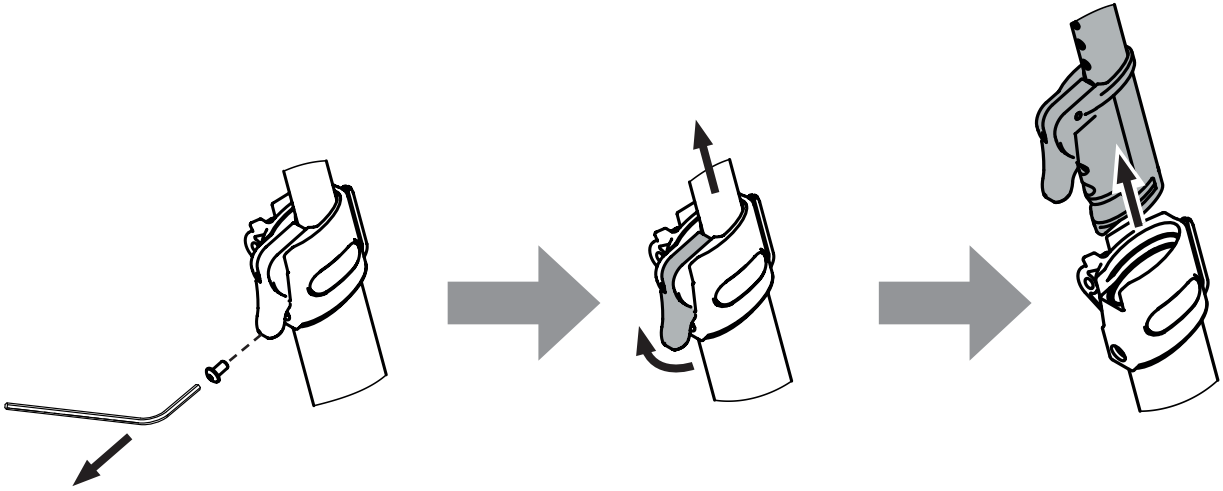

2

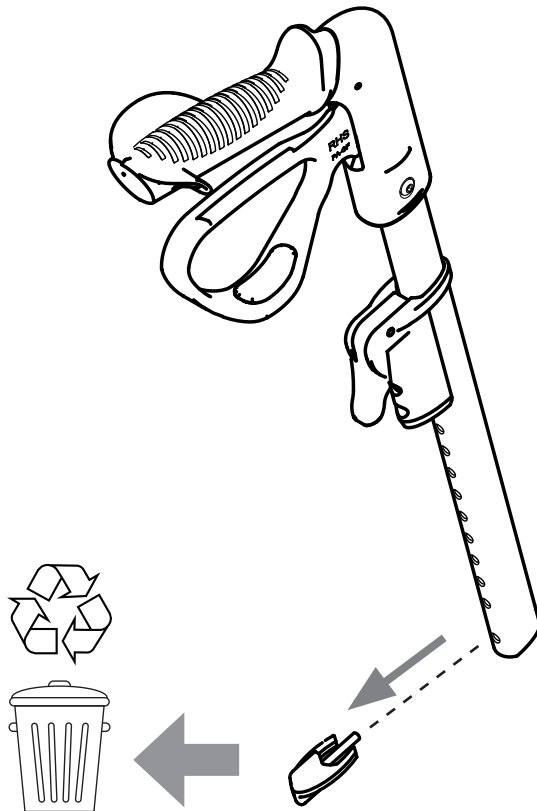

3

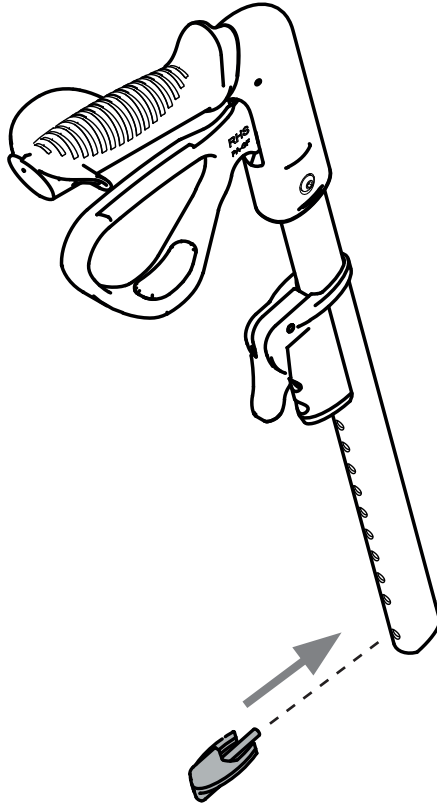

4

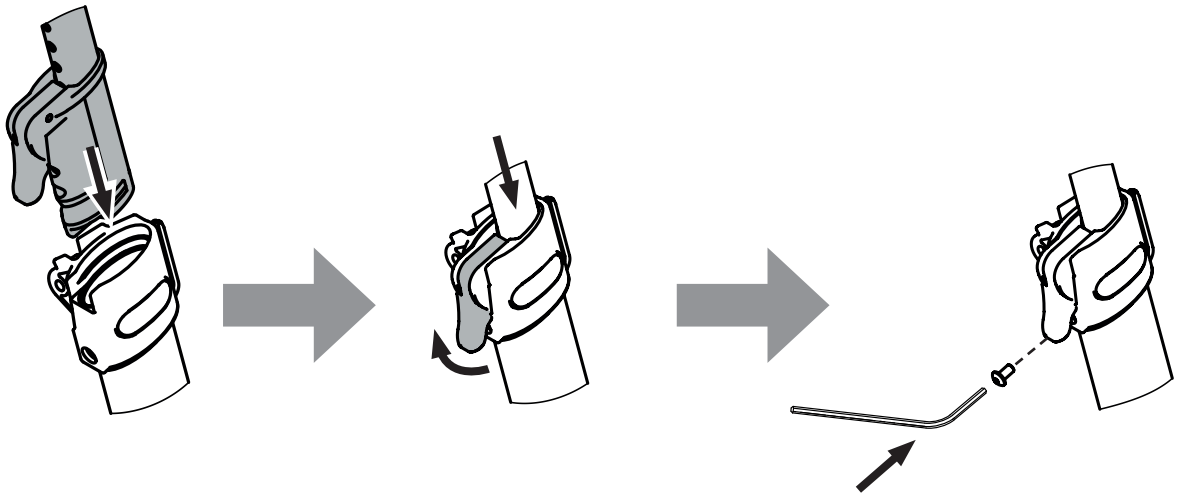

Sunrise Medical S.r.l.  
Via Riva, 20 – Montale  
29122 Piacenza  
Italia  
Tel.: +39 0523 573111  
Fax: +39 0523 570060  
www.SunriseMedical.it

Sunrise Medical AG  
Erlenauweg 17  
CH-3110 Münsingen  
Schweiz/Suisse/Svizzera  
Fon +41 (0)31 958 3838  
Fax +41 (0)31 958 3848  
www.SunriseMedical.ch

Sunrise Medical AS  
Delitoppen 3  
1540 Vestby  
Norge  
Telefon: +47 66 96 38 00  
post@sunrisemedical.no  
www.SunriseMedical.no

Sunrise Medical AB  
Neogatan 5  
431 53 Mölndal  
Sweden  
Tel.: +46 (0)31 748 37 00  
post@sunrisemedical.se  
www.SunriseMedical.se

MEDICCO s.r.o.  
H – Park, Heršpická 1013/11d,  
639 00 Brno  
Czech Republic  
Tel.: (+420) 547 250 955  
Fax: (+420) 547 250 956  
www.medicco.cz  
info@medicco.cz  
Bezplatná linka 800 900 809

Sunrise Medical Aps  
Mårkærvej 5-9  
2630 Taastrup  
Denmark  
+45 70 22 43 49  
info@sunrisemedical.dk  
Sunrisemedical.dk

Sunrise Medical Australia  
11 Daniel Street  
Wetherill Park NSW 2164  
Australia  
Ph: +61 2 9678 6600  
E: enquiries@sunrisemedical.com.au  
www.SunriseMedical.com.au

Sunrise Medical  
North American Headquarters  
2842 Business Park Avenue  
Fresno, CA, 93727, USA  
(800) 333-4000  
(800) 300-7502  
www.SunriseMedical.com



Sunrise Medical GmbH  
Kahlbachring 2-4  
69254 Malsch/Heidelberg  
Deutschland  
Tel.: +49 (0) 7253/980-0  
Fax: +49 (0) 7253/980-222  
www.SunriseMedical.de

Sunrise Medical  
Thorns Road  
Brierley Hill  
West Midlands  
DY5 2LD  
England  
Phone: 0845 605 66 88  
Fax: 0845 605 66 89  
www.SunriseMedical.co.uk

Sunrise Medical S.L.  
Polígono Bakiola, 41  
48498 Arrankudiaga – Vizcaya  
España  
Tel.: +34 (0) 902142434  
Fax: +34 (0) 946481575  
www.SunriseMedical.es

Sunrise Medical Poland  
Sp. z o.o.  
ul. Elektronowa 6,  
94-103 Łódź  
Polska  
Telefon: + 48 42 275 83 38  
Fax: + 48 42 209 35 23  
E-mail: pl@sunrisemedical.de  
www.Sunrise-Medical.pl

Sunrise Medical B.V.  
Groningenhaven 18-20  
3433 PE NIEUWEGEIN  
The Netherlands  
T: +31 (0)30 – 60 82 100  
F: +31 (0)30 – 60 55 880  
E: info@sunrisemedical.nl  
www.SunriseMedical.nl

Sunrise Medical HCM B.V.  
Vossenbeemd 104  
5705 CL Helmond  
The Netherlands  
T: +31 (0)492 593 888  
E: customerservice@sunrisemedical.nl  
www.SunriseMedical.nl  
www.SunriseMedical.eu  
(International)

Sunrise Medical SAS  
ZAC de la Vrillonnerie  
17 Rue Michaël Faraday  
37170 Chambray-Lès-Tours  
Tel : +33 (0) 2 47 55 44 00  
Email: info@sunrisemedical.fr  
www.sunrisemedical.fr

