



**Customer Contact Details**

Customer Name: \_\_\_\_\_

Advisor: \_\_\_\_\_

Address: \_\_\_\_\_  
 \_\_\_\_\_  
 \_\_\_\_\_

Phone: \_\_\_\_\_

Email: \_\_\_\_\_

Ship to Customer Address:

Shipping Name: \_\_\_\_\_

Shipping Address: \_\_\_\_\_  
 \_\_\_\_\_  
 \_\_\_\_\_

Phone: \_\_\_\_\_

Email: \_\_\_\_\_

**Additional Information**

Notes: \_\_\_\_\_  
 \_\_\_\_\_  
 \_\_\_\_\_

Current Wheelchair: \_\_\_\_\_

Customer Weight: \_\_\_\_\_

Customer Height: \_\_\_\_\_

Customer Disability: \_\_\_\_\_

**Other**

VAT Exemption Declaration (UK Only):  
 I declare that I am chronically sick or disabled by reason of:  
 \_\_\_\_\_  
 and that I am receiving from RGK Wheelchairs Ltd, the wheelchair specified herein and I claim relief from Value Added Tax under group 12 of schedule 8 to Value Added Tax Act 1994.  
 Signature: \_\_\_\_\_ Date: \_\_\_\_\_

RGK Contact Authorisation:  
 From time to time, RGK would like to send you exclusive information, news and offers on everything RGK, by email or post. We will not pass any of your details to any third party.  
 I would like to be contacted by RGK:   
 Signature: \_\_\_\_\_ Date: \_\_\_\_\_

SERIAL NO: \_\_\_\_\_

Guide:

- Base product
- Required option
- Optional Extra
- Critical Information
- Information Needed
- Non certified Sub4 weight option

**PRODUCT STYLE**

SBCXZ010 VEYPR SUB4

XA070 Open design

Max User Weight 110kg (242lbs)

PLEASE NOTE: ALL RGK CHAIRS ARE HAND BUILT AND HAVE A MANUFACTURING MEASUREMENT TOLERANCE OF +/- 5MM

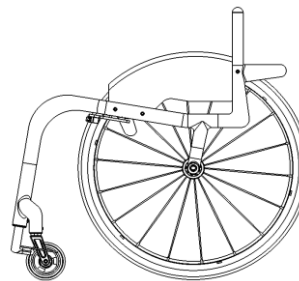

**CAD APPROVAL**

XW009 QUOTE ONLY (NO CAD FOR APPROVAL)

XW011 ORDER (NO CAD FOR APPROVAL)

XW012 QUOTE CAD drawing for approval (2 customer amendments ONLY)

XW010 ORDER CAD drawing for approval (2 customer amendments ONLY)

**KEY MEASUREMENTS**

XY010 Seat width (Inside of sideguards)

 mm

(Max - 440mm)  
(Min - 250mm)

XY020 Seat length

 mm

(Max - 440mm)  
(Min - 250mm)

XY030 Extra seat length (Provides additional leg support & hand grip)

 mm

(Max - 440mm total seat)

XY050 Front frame height

 mm

(Max - 520mm)  
(Min - 380mm)

XY060 Rear frame height

 mm

(Max - 500mm)  
(Min - 380mm)

XY070 Frame length

 mm

(Min = XY020 + XY030 + 140mm)  
(Max - 625mm)

XY072 Castor position

 mm

Optimise measurements

XA020 Ergonomic seat

Specify length

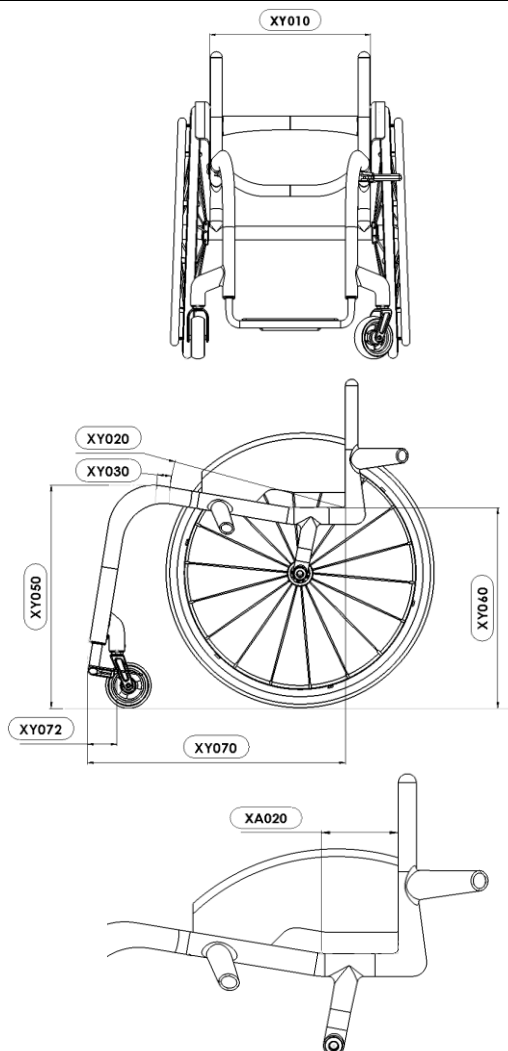
 mm

### FRONT FRAME AND FOOTREST

Front Frame Options

XY080 Seat taper design

**i** Specify width  mm

*(When combined with XY091, dimension is inbetween the centre of the main bends)*

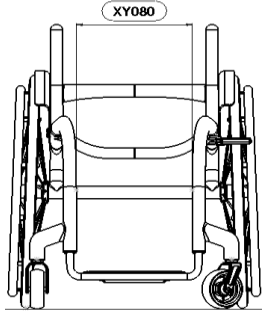

XY091 Parallel taper design

**i** Specify width  mm

*(When combined with XY080, dimensions must be smaller by 20mm)*

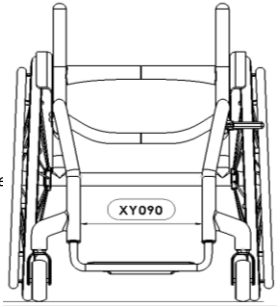

---

Footrest Design (Choose one)

XY100 Round design

Castor Wheel Size	Max Height Achievable
4"	130

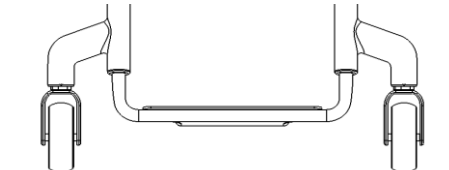

---

Footrest Measurements

XY115 Front footrest height

**!**  mm

XY120 Rear footrest height

**i**  mm *Std = 20 lower than front height*

XY125 Footrest length

**i**  mm *Maximum length 120mm (Certified weight)*

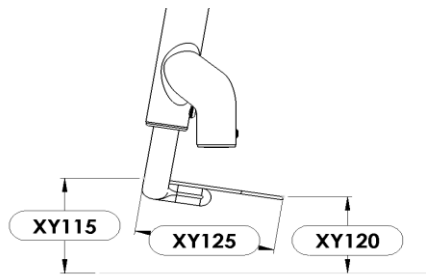

---

Footrest Style

SBCXB400 Carbon Fibre Footrest with Carbon Plate

*(Height adjustable +/-10mm)*

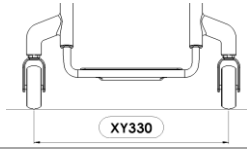
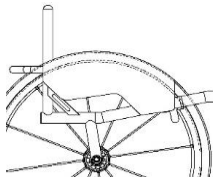
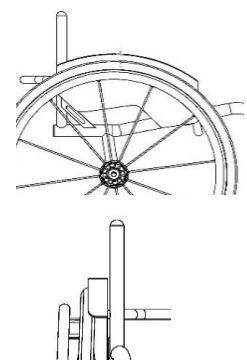
CASTOR WHEELS, FORKS & WHEEL LOCKS							
Castor Wheels							
<input type="checkbox"/> XC135	Aluminium centre 4"x1.25" <i>Choose colour below:</i>						
<b>i</b>	<table style="width: 100%; border: none;"> <tr> <td style="width: 50%;"><input type="checkbox"/> Silver hub &amp; black tyre (Std)</td> <td style="width: 50%;"><input type="checkbox"/> Green hub &amp; black tyre</td> </tr> <tr> <td><input type="checkbox"/> Black hub &amp; black tyre</td> <td><input type="checkbox"/> Red hub &amp; black tyre</td> </tr> <tr> <td><input type="checkbox"/> Purple hub &amp; black tyre</td> <td><input type="checkbox"/> Blue hub &amp; black tyre</td> </tr> </table>	<input type="checkbox"/> Silver hub & black tyre (Std)	<input type="checkbox"/> Green hub & black tyre	<input type="checkbox"/> Black hub & black tyre	<input type="checkbox"/> Red hub & black tyre	<input type="checkbox"/> Purple hub & black tyre	<input type="checkbox"/> Blue hub & black tyre
<input type="checkbox"/> Silver hub & black tyre (Std)	<input type="checkbox"/> Green hub & black tyre						
<input type="checkbox"/> Black hub & black tyre	<input type="checkbox"/> Red hub & black tyre						
<input type="checkbox"/> Purple hub & black tyre	<input type="checkbox"/> Blue hub & black tyre						
<input checked="" type="checkbox"/> SBCXC155	Forged carbon centre 4"x1.4" <b>(Non certified Sub4 option)</b>						
<input checked="" type="checkbox"/> XC140	Aluminium centre 5"x1.4" <b>(Non certified Sub4 option)</b> <i>(Silver hub and black tyre only)</i>						
<input checked="" type="checkbox"/> XC145	Aluminium centre 6"x1.4" <b>(Non certified Sub4 option)</b> <i>(Silver hub and black tyre only)</i>						
Castor Forks							
<input type="checkbox"/> XC190	Performance castor fork <b>(Std)</b> <i>Choose colour</i>						
<input type="checkbox"/> XC192	High trail castor fork <i>Choose colour</i>						
<i>Note: Greater distance between contact patch and steering axis reduces flutter at higher speeds.</i>							
<table style="width: 100%; border: none;"> <tr> <td style="width: 33%;"><input type="checkbox"/> Black</td> <td style="width: 33%;"><input type="checkbox"/> Red</td> <td style="width: 33%;"><input type="checkbox"/> Silver</td> </tr> <tr> <td><input type="checkbox"/> Blue</td> <td><input type="checkbox"/> Purple</td> <td></td> </tr> </table>		<input type="checkbox"/> Black	<input type="checkbox"/> Red	<input type="checkbox"/> Silver	<input type="checkbox"/> Blue	<input type="checkbox"/> Purple	
<input type="checkbox"/> Black	<input type="checkbox"/> Red	<input type="checkbox"/> Silver					
<input type="checkbox"/> Blue	<input type="checkbox"/> Purple						
Castor Pin Width							
<input checked="" type="checkbox"/> XY330	Castor pin width						
<input checked="" type="checkbox"/>	Optimise measurements <i>(Minimum width for clear castor rotation and maximum wheelbase length)</i>						
							
Wheel Lock Options							
<input type="checkbox"/> SBCXD036	Compact scissor with lightweight fixing						
<input type="checkbox"/> XD010	Omit wheel locks						
SIDEGUARDS							
Sideguard without Fender	Sideguard with Fender						
<input type="checkbox"/> XE055	Screw on lightweight carbon fibre						
<input type="checkbox"/> XE065	Screw on lightweight carbon fibre w/fender						
Sideguard Measurements	Sideguard Measurements						
<input type="checkbox"/>	Individual above tyre <i>(Follow tyre - max. 25mm)</i>						
<b>i</b>	<input style="width: 100px;" type="text"/> mm						
<input type="checkbox"/>	Level with tyre <i>(Follow tyre)</i>						
							
<input type="checkbox"/>	10mm above tyre <i>(Standard)</i>						
<input type="checkbox"/>	Individual above tyre <i>(Min = 10mm)</i>						
<b>i</b>	<input style="width: 100px;" type="text"/> mm						
<input checked="" type="checkbox"/>	Centre of tyre						
							

BACKREST	
Backrest Height - Fixed	
<input checked="" type="checkbox"/> XY230    Backrest height Specify height (400mm max) ⓘ <input style="width: 100px;" type="text"/> mm 	<input checked="" type="checkbox"/> XG010    Fixed Backrest (non-folding)
Ergonomic Options	
<input type="checkbox"/> XY360    Backrest angle ⓘ <input type="checkbox"/> -5 <input type="checkbox"/> -3 <input type="checkbox"/> 0 <input type="checkbox"/> +3 <input type="checkbox"/> +5 Individual <input style="width: 100px;" type="text"/> Deg (Max -10/+20 Deg) 	<input type="checkbox"/> XG100    Ergonomic backrest ⓘ Vertical height <input style="width: 100px;" type="text"/> mm ⓘ Rearward position <input style="width: 100px;" type="text"/> mm 
<input type="checkbox"/> XG110    Inward taper (inside of backrest posts) ⓘ Specify width or per side <input style="width: 100px;" type="text"/> mm 	<input type="checkbox"/> XG120    Outward flare (inside of backrest posts) ⓘ Specify width or per side <input style="width: 100px;" type="text"/> mm 
CAMBER BAR	
Camber Angle <input checked="" type="checkbox"/> XY390    Camber angle ⓘ <input type="checkbox"/> 1 <input type="checkbox"/> 2 <input type="checkbox"/> 3	Centre of Gravity <input checked="" type="checkbox"/> SBCXH100    Single post fixed centre of gravity (25-125mm) ⓘ Specify length <input style="width: 100px;" type="text"/> mm 
PUSH HANDLES	
<input checked="" type="checkbox"/> XG080    Flip down push handles (Non Certified Sub4 option)	
ANTI-TIP	
<input checked="" type="checkbox"/> XJ100    Single sport anti tip (Non Certified Sub4 option)	

FRAME FINISH OPTIONS			
Frame and Footrest			
<input type="checkbox"/> SBCXN300 Carbon Fibre Matte finish	<input type="checkbox"/> SBCXN305 Carbon Fibre Gloss finish		
Accent Colour (Choose One)			
<i><b>Note:</b> Accent colour includes decals only</i>			
<b>i</b>	<input type="checkbox"/> Black	<input type="checkbox"/> White	<input type="checkbox"/> Purple
	<input type="checkbox"/> Red	<input type="checkbox"/> Blue	<input type="checkbox"/> Orange
	<input type="checkbox"/> Pink	<input type="checkbox"/> Green	<input type="checkbox"/> None
	<input type="checkbox"/> SBCXN250 Individual Accent Colour _____		
UPHOLSTERY			
Seat Upholstery			
<input type="checkbox"/> XP045 Sub4 Seat sling strap adjustable	<input checked="" type="checkbox"/> XR050 Carbon fibre seat plate <b>(Non certified Sub4 option)</b>		
Backrest Upholstery			
<input type="checkbox"/> XP035 Airtech Sub4 backrest strap adjustable	<input checked="" type="checkbox"/> XP050 Airtech backrest strap adjustable <b>(Non certified Sub4 option)</b>		
	<input checked="" type="checkbox"/> XP070 Backrest upgrade to leather corners (Black) <b>(only with Airtech upholstery XP050)</b> <b>(Non certified Sub4 option)</b>		
	<input checked="" type="checkbox"/> XP110 Backrest with zip pocket <b>(only with Airtech upholstery XP050)</b> <b>(Non certified Sub4 option)</b>		
	<input checked="" type="checkbox"/> XP170 Individual backrest embroidery <b>(only with Airtech upholstery XP050)</b> <i>Please complete page 9</i>		
Backrest Upholstery Stitching Options			
<input type="checkbox"/> Silver (Std)	<input type="checkbox"/> Black	<input type="checkbox"/> Blue	<input type="checkbox"/> Individual: _____
<input type="checkbox"/> Red	<input type="checkbox"/> Purple	<input type="checkbox"/> Orange	_____
Backrest Upholstery Logo Colour			
<input type="checkbox"/> White (Std)	<input type="checkbox"/> Black	<input type="checkbox"/> Blue	<input type="checkbox"/> Individual: _____
<input type="checkbox"/> Red	<input type="checkbox"/> Purple	<input type="checkbox"/> Orange	_____

4 REAR WHEELS (* non certified weight options)	
Rear Wheel Size	
<input type="checkbox"/> XY420 24" Wheels	<input type="checkbox"/> XY430 25" Wheels
Rear Wheel Gap	
<input checked="" type="checkbox"/> XY460 Rear wheel gap 15 <input type="checkbox"/> 20 <input type="checkbox"/> 25	XY460 
Rear Wheel Options	
<input type="checkbox"/> XK075 Spinergy <b>BLXL</b> 18 blade spoke <i>N/A IN SILVER HUB</i>	<input type="checkbox"/> SBCXK150 Spinergy <b>CLX</b> 18 carbon blade spoke <i>N/A IN SILVER HUB</i>
<input checked="" type="checkbox"/> XK226 Titanium 100mm quick release axle pins	
<b>Spinergy Colour Options:</b>	
<input type="checkbox"/> Black spokes <input type="checkbox"/> White spokes <input type="checkbox"/> Yellow spokes <input type="checkbox"/> Red spokes <input type="checkbox"/> Blue spokes <input type="checkbox"/> Pink spokes <input type="checkbox"/> Purple spokes <input type="checkbox"/> Orange spokes <input type="checkbox"/> Green spokes	<input type="checkbox"/> XK180 Individual spoke design <i>(Specify colour)</i> Inside: _____ Outside: _____
<b>Spinergy Anodise Options</b>	
<input type="checkbox"/> XK190 Black hub <i>(std option)</i>	<input type="checkbox"/> XK201 Red hub/rims <i>(LX, XLX &amp; BLXL only)</i>
<input type="checkbox"/> XK202 Purple hub/rims <i>(LX, XLX &amp; BLXL only)</i>	<input type="checkbox"/> XK203 Blue hub/rims <i>(LX, XLX &amp; BLXL only)</i>
<input type="checkbox"/> XK204 Gold hub/rims <i>(LX, XLX &amp; BLXL only)</i>	<input type="checkbox"/> XK205 Individual hub/rims Select colour: _____
Supply Without Wheels	
<input type="checkbox"/> SBCXK040 Supply without Wheels	Wheel Type: <input style="width: 150px;" type="text"/> Tyre Type: <input style="width: 150px;" type="text"/>
Handrim Position / Options	
<input type="checkbox"/> XY480 Narrow set handrim	<input type="checkbox"/> XY485 Wide set handrim
<input type="checkbox"/> XL090 Remove excess mounting tabs <i>(recommended for small wheel gaps)</i>	
Handrim Styles	
<input type="checkbox"/> XL010 Aluminium hard anodised 6 tab	<input type="checkbox"/> XL040 Titanium 6 tab
<input type="checkbox"/> XL160 Elipse 6 tab <i>(replacement for Surge)</i>	<input type="checkbox"/> XL035 Natural Fit LT
<input type="checkbox"/> XL020 Tetra grip 6 tab	<input type="checkbox"/> XL150 Carbolife Gekko <input type="checkbox"/> Black <input type="checkbox"/> Silver
<input type="checkbox"/> XL100 Para grip 6 tab	<input type="checkbox"/> XL170 Carbolife Curve L <i>(Black)</i>
Tyre Options	
<input type="checkbox"/> XM060 Schwalbe One (Lightest option)	<input type="checkbox"/> XM130 Kenda black
<input type="checkbox"/> XM010 Kenda <input type="checkbox"/> Grey <input type="checkbox"/> Blue <input type="checkbox"/> Red	<input type="checkbox"/> XM050 Kenda K885 mountain bike tyre <i>(24", 25" only)</i>
<input type="checkbox"/> XM020 Schwalbe Marathon Plus	
<input type="checkbox"/> XM040 Shox solid airless	
Inner Tube Valve Options	
<input type="checkbox"/> XY500 Schraeder inner tube valve <i>(Standard if no option selected)</i>	<input type="checkbox"/> XY490 Presta inner tube valve

\* Indicates items that are not part of the certified weight of the Tiga Sub4

<span style="border: 1px solid black; border-radius: 50%; padding: 2px;">4</span> <b>CUSHION (** non certified weight options)</b>	
Cushion foam options	
<input type="checkbox"/> XP080	Cushion foam <i>(select density and size below)</i>
<input type="checkbox"/> Soft (CMS040)	<input type="checkbox"/> Medium (CMS050)
<input type="checkbox"/> 50mm	<input type="checkbox"/> 75mm <input type="checkbox"/> 100mm
Cushion cover upgrades	
<input type="checkbox"/> XP085	Nylon cushion cover <i>(Black)</i>
<input type="checkbox"/> XP090	Airlite cushion cover <i>(Black)</i>
<input type="checkbox"/> XP100	Leather cushion cover <i>(Black)</i>
Jay Products	
<input type="checkbox"/> JAY Cushion <i>(Price dependant on size / option)</i>	<input style="width: 100%;" type="text" value="Refer to Jay Order Form"/>
<input type="checkbox"/> JAY Backrest <i>(Price dependant on size / option)</i>	<input style="width: 100%;" type="text" value="Refer to Jay Order Form"/>
<span style="border: 1px solid black; border-radius: 50%; padding: 2px;">4</span> <b>ACCESSORIES (** non certified weight options)</b>	
<input type="checkbox"/> XP120	Frame protectors Neoprene zip fasten (Black)
<input type="checkbox"/> XP420	Frame protectors Nylon velcro fasten (Black)
<input type="checkbox"/> XR010	Seat pouch velcro attach <i>(Black)</i>
<input type="checkbox"/> XR200	Rucksack with RGK logo (Black)
<input checked="" type="checkbox"/> XR090	Tool kit
<input checked="" type="checkbox"/> XS065	Sub4 Calf Strap
** indicates options that, when chosen, will not enable RGK to guarantee a Sub4kg product weight	



**ADDITIONAL NOTES**

**INDIVIDUAL BACKREST EMBROIDERY**

PLEASE PROVIDE JPEG IMAGE AT TIME OF ORDER AND NOTE POSITION BELOW



**BRACE BAR**

**SPEC NOTES:**

**OFF SPEC REQUEST\*** *(please specify below the page number(s) and details to which the off spec request applies.*

**OFF SPEC REQUEST APPROVED** *(for internal RGK office only)*

X  
*RGK Internal Sign-off*

Off spec requests require a feasibility study which may increase order price and lead time. Any dimension/ option/ frame request not listed on the order form will be treated as an off spec request.\*