



Kunde/HMS:  
Kont.person  
E-post:  
Tlf:  
Best.dato:  
Notater:

Lever til:  
Bruker-ref:  
E-post:  
Tlf:  
Sunrise ordrenr:  
Merkes:

- Bestilling  
 Prisoverslag  
 Individuell tilpasning



- = Standard      □ = Tilbehør/prisendring  
○ = valgmulighet

**OBS!** Vi gjør oppmerksom på at informasjon som legges inn i dette skjemaet vil bli lagret hos leverandør i inntil 3 år.

**Art nr: 82000001**

**Maks brukervekt: 125 kg**  
**Brukervekt:**  kg  
Nødvendig for å sikre riktig konfigurasjon

**Brukers mål (Alle mål er uten setetepute)**

**SETEBREDDE** - Målt mellom utside rammerør til utside rammerør

<input type="radio"/>	Base str 1	(setebredde 30 cm; setedybde justerbar fra 37,5 cm-45 cm)	ZRS010104
<input type="radio"/>	Base str 2	(setebredde 35 cm; setedybde justerbar fra 37,5 cm-45 cm)	ZRS010105
<input type="radio"/>	Base str 3	(setebredde 40 cm; setedybde justerbar fra 37,5 cm-45 cm)	ZRS010106

**SETEDYBDE VALG** - Forhåndsvalgt innstilling fra fabrikk; alle setedybder er justerbare fra 37,5 cm-45 cm.

<input type="radio"/>	37,5 cm	SD375
<input checked="" type="radio"/>	40,0 cm	SD400
<input type="radio"/>	42,5 cm	SD425
<input type="radio"/>	45,0 cm	SD450

**SETEHØYDE VALG** - Avhengig av svinghjul og plassering av drivhjulsbrakett

Svinghjul	Drivhjul	Drivhjuls-plassering	Setehøyde i centimeter													
			43	44	45	46	47	48	49	50	51	52				
6"	16"	Aktiv	<input type="radio"/>	<input type="radio"/>	<input type="radio"/>	<input type="radio"/>	<input type="radio"/>	<input type="radio"/>	<input type="radio"/>	<input type="radio"/>	<input type="radio"/>	<input type="radio"/>	<input type="radio"/>	<input type="radio"/>	<input type="radio"/>	<input type="radio"/>
	22"		<input type="radio"/>	<input type="radio"/>	<input type="radio"/>	<input type="radio"/>	<input type="radio"/>	<input type="radio"/>	<input type="radio"/>	<input type="radio"/>	<input type="radio"/>	<input type="radio"/>	<input type="radio"/>	<input type="radio"/>	<input type="radio"/>	<input type="radio"/>
	24"		<input type="radio"/>	<input type="radio"/>	<input type="radio"/>	<input type="radio"/>	<input type="radio"/>	<input type="radio"/>	<input type="radio"/>	<input type="radio"/>	<input type="radio"/>	<input type="radio"/>	<input type="radio"/>	<input type="radio"/>	<input type="radio"/>	<input type="radio"/>
6"	16"	Passiv	<input type="radio"/>	<input type="radio"/>	<input type="radio"/>	<input type="radio"/>	<input type="radio"/>	<input type="radio"/>	<input type="radio"/>	<input type="radio"/>	<input type="radio"/>	<input type="radio"/>	<input type="radio"/>	<input type="radio"/>	<input type="radio"/>	
	22"		<input type="radio"/>	<input type="radio"/>	<input type="radio"/>	<input type="radio"/>	<input type="radio"/>	<input type="radio"/>	<input type="radio"/>	<input type="radio"/>	<input type="radio"/>	<input type="radio"/>	<input type="radio"/>	<input type="radio"/>	<input type="radio"/>	
	24"		<input type="radio"/>	<input type="radio"/>	<input type="radio"/>	<input type="radio"/>	<input type="radio"/>	<input type="radio"/>	<input type="radio"/>	<input type="radio"/>	<input type="radio"/>	<input type="radio"/>	<input type="radio"/>	<input type="radio"/>	<input type="radio"/>	
7"	16"	Aktiv	<input type="radio"/>	<input type="radio"/>	<input type="radio"/>	<input type="radio"/>	<input type="radio"/>	<input type="radio"/>	<input type="radio"/>	<input type="radio"/>	<input type="radio"/>	<input type="radio"/>	<input type="radio"/>	<input type="radio"/>	<input type="radio"/>	
	22"		<input type="radio"/>	<input type="radio"/>	<input type="radio"/>	<input type="radio"/>	<input type="radio"/>	<input type="radio"/>	<input type="radio"/>	<input type="radio"/>	<input type="radio"/>	<input type="radio"/>	<input type="radio"/>	<input type="radio"/>	<input type="radio"/>	
	24"		<input type="radio"/>	<input type="radio"/>	<input type="radio"/>	<input type="radio"/>	<input type="radio"/>	<input type="radio"/>	<input type="radio"/>	<input type="radio"/>	<input type="radio"/>	<input type="radio"/>	<input type="radio"/>	<input type="radio"/>	<input type="radio"/>	
7"	16"	Passiv	<input type="radio"/>	<input type="radio"/>	<input type="radio"/>	<input type="radio"/>	<input type="radio"/>	<input type="radio"/>	<input type="radio"/>	<input type="radio"/>	<input type="radio"/>	<input type="radio"/>	<input type="radio"/>	<input type="radio"/>	<input type="radio"/>	
	22"		<input type="radio"/>	<input type="radio"/>	<input type="radio"/>	<input type="radio"/>	<input type="radio"/>	<input type="radio"/>	<input type="radio"/>	<input type="radio"/>	<input type="radio"/>	<input type="radio"/>	<input type="radio"/>	<input type="radio"/>	<input type="radio"/>	
	24"		<input type="radio"/>	<input type="radio"/>	<input type="radio"/>	<input type="radio"/>	<input type="radio"/>	<input type="radio"/>	<input type="radio"/>	<input type="radio"/>	<input type="radio"/>	<input type="radio"/>	<input type="radio"/>	<input type="radio"/>	<input type="radio"/>	
8"	16"	Aktiv	<input type="radio"/>	<input type="radio"/>	<input type="radio"/>	<input type="radio"/>	<input type="radio"/>	<input type="radio"/>	<input type="radio"/>	<input type="radio"/>	<input type="radio"/>	<input type="radio"/>	<input type="radio"/>	<input type="radio"/>	<input type="radio"/>	
	22"		<input type="radio"/>	<input type="radio"/>	<input type="radio"/>	<input type="radio"/>	<input type="radio"/>	<input type="radio"/>	<input type="radio"/>	<input type="radio"/>	<input type="radio"/>	<input type="radio"/>	<input type="radio"/>	<input type="radio"/>	<input type="radio"/>	
	24"		<input type="radio"/>	<input type="radio"/>	<input type="radio"/>	<input type="radio"/>	<input type="radio"/>	<input type="radio"/>	<input type="radio"/>	<input type="radio"/>	<input type="radio"/>	<input type="radio"/>	<input type="radio"/>	<input type="radio"/>	<input type="radio"/>	
8"	16"	Passiv	<input type="radio"/>	<input type="radio"/>	<input type="radio"/>	<input type="radio"/>	<input type="radio"/>	<input type="radio"/>	<input type="radio"/>	<input type="radio"/>	<input type="radio"/>	<input type="radio"/>	<input type="radio"/>	<input type="radio"/>	<input type="radio"/>	
	22"		<input type="radio"/>	<input type="radio"/>	<input type="radio"/>	<input type="radio"/>	<input type="radio"/>	<input type="radio"/>	<input type="radio"/>	<input type="radio"/>	<input type="radio"/>	<input type="radio"/>	<input type="radio"/>	<input type="radio"/>	<input type="radio"/>	
	24"		<input type="radio"/>	<input type="radio"/>	<input type="radio"/>	<input type="radio"/>	<input type="radio"/>	<input type="radio"/>	<input type="radio"/>	<input type="radio"/>	<input type="radio"/>	<input type="radio"/>	<input type="radio"/>	<input type="radio"/>	<input type="radio"/>	

Drivhjuls plassering (tyngdepunkt)

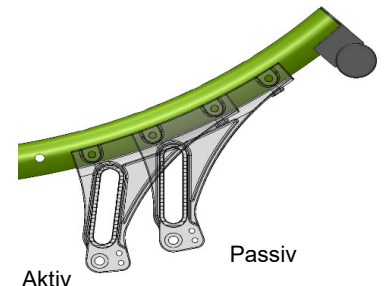

Viktig for sikkerheten i forhold til tyngdepunktet. Passiv=tung på tippen

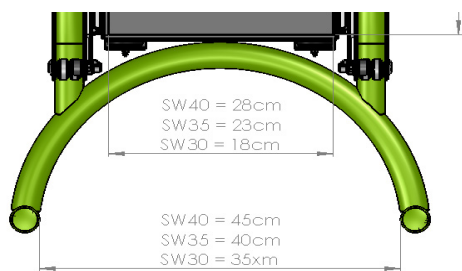

Stol dimensjoner

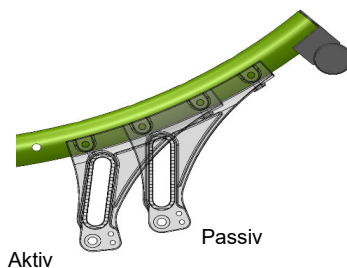

stolkarakter

**Aktiv:**

- enkel å skyve og tippe
- Kort hjulavstand

**Passiv:**

- tung å tippe
- lengre hjulavstand

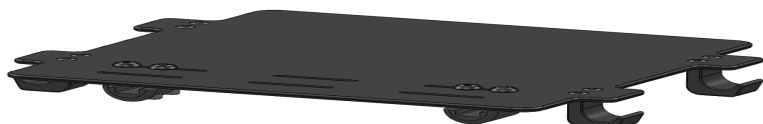

Seteplate

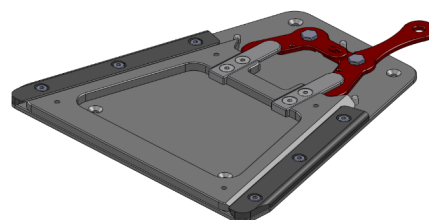

Trapesadapter komplett

dekk



Right Run



Marathon Plus



Kompakt

Drivringer



Aluminium søveloksert



Farget aluminium



Maxgrepp

**Tekniske Data:**

**Maks totale høyde:** 80 - 145 cm  
**Maks totale lengde:** 90 - 145 cm  
**Maks totale bredde:** 53 - 63 cm

**Maks svingradius:** 750 mm  
**Maks sikre helling:** 10°  
**Stolvekt:** fra 18 kg  
**Vekt uten drivhjul:** 14 - 22 kg  
**Vekt tyngste del:** 2,1 kg

Produktet er **crash testet** i henhold til ISO 7176-19 og derfor godkjent som sete i bil.  
 For transport uten bruker må stolen stropes forsvarlig

Alle endringer i konfigurasjonen kan endre setehøyden.  
 produksjonstoleranser +/- 1 cm

# Zippie RS

● = Standard    ○ =Uten tillegg i prisen    □ = Tillegg i prisen

SETE		Artikkelnummer
ZRS020109	● Seteplate	82002044-001,-2,-3
ZRS020151	□ Trapes adapter komplett, alu. (Lengde: 30cm; bredde (front): 28cm; bredde (bak): 14cm) (ikke montert)	82002203
ZRS090018	□ Hoftebelte (ikke montert)	063969
ikke i Calico	□ Kinetic Balance hoftebelte. Angi art nr: <input type="text"/>	

## JAY puter -: [\(se Jaykatalog for komplett sortiment\)](#)

JAY020002	□ JAY Basic	Art nr: <input type="text"/>	(Ikke med Trapes (ZRS020151))
JAY020003	□ JAY Soft Combi P	Art nr: <input type="text"/>	(Ikke med Trapes (ZRS020151))
JAY020001	□ JAY Easy Visco	Art nr: <input type="text"/>	(Ikke med Trapes (ZRS020151))
ikke i Calico	□ JAY GS	Art nr: <input type="text"/>	(Ikke med Trapes (ZRS020151))

Svinghjul		Artikkelnummer
ZRS080301	○ Kompakt	6": 000858043, 7": 000858150 8": 757858164
ZRS080302	○ Soft solid	(bare 6") 760858364
ZRS080305	○ Luft	7": 000858151 8": 757858055

Dekk til drivhjul		Artikkelnummer
ZRS070102	○ Kompakt	22": 00283028 24": 000283015.01
ZRS070101	○ Right Run (luft) (bare 22"/24")	22": 00283016.01 24": 000283014.01
ZRS070104	□ Marathon plus evolution (bare 24")	000283036

Drivringer		Artikkelnummer
ZRS070202	○ Aluminium sølv eloksert (bare 22"/24")	22": 000854017 24": 000854026.28
ZRS070201	○ Aluminium klarlakkert (bare 22"/24")	22": 000854017.01 24": 000854026.30
ZRS070203	□ Aluminium lakkert farget (bare 22"/24")	22": 000854035.22 24": 000854035.24
ZRS070208	□ Maxgrepp (bare 22"/24")	22": 062542 24": 062544
ZRS070317	● Drivring montert nær 17mm (bare 22"/24")	

Bremser		Artikkelnummer
ZRS070008	● Drivhjul med trommelbrens	
ZRS060008	□ Brems høy kompositt med bremsepakforlenger (I tillegg til ledagerbrens. Kun 22" / 24")	

## Eikebeskyttere [Se brosjyre for Eikebeskyttere](#) (bare 22" / 24")

ZRS070831	□ Transparent	
ZRS070823	□ Princess	ZRS070813 □ Galactica
ZRS070816	□ Happy Lions	ZRS070821 □ Pirates
ZRS070819	□ Monkeys	ZRS070814 □ Graffiti
ZRS070820	□ Oriental	ZRS070802 □ Basketball
ZRS070829	□ Superhero	ZRS070812 □ Flying Water
ZRS070817	□ Hot Wheels	ZRS070833 □ Zebra
ZRS070822	□ Pool	
ZRS070827	□ Silk	
ZRS070830	□ Tiger	



For mere informasjon  
besøk vår hjemmeside  
[www.SunriseMedical.no](http://www.SunriseMedical.no)  
© Sunrise Medical 2022



Klesbeskytter med kant



Vinkel og høyderegulerbar kjørebøyle



Feste for rygg

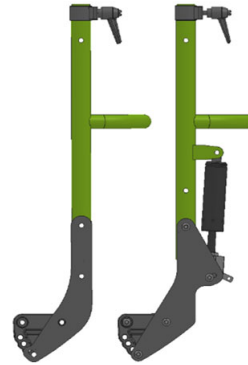

Vinkeljusterbar rygg

Vinkelregulerbar rygg



Hodestøtte

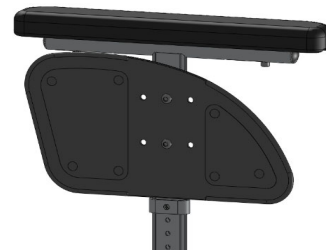

Høyde og dybdejusterbart armlen (33cm)

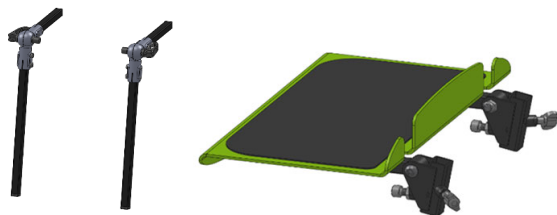

Hel oppfellbar og vinkeljusterbar fotplate med hælstopper



Utsvingbare delte fotplater(hengere i rammens farge)

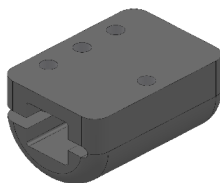

Feste for spesial benstøtter til 15x15 mm firkantrør

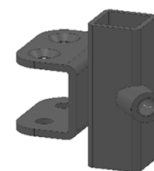

Feste for spesial armlener til 15x15 mm firkantrør



Vinkelregulerbare beinstøtter

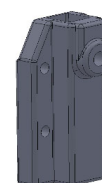

Feste for spesial hodestøtter til 15x15 mm firkantrør

# Zippie RS

● = Standard    ○ =Uten tillegg i prisen    □ = Tillegg i prisen

Artikkelnummer

## KLESBESKYTTERE/ARMLLEN

ZRS040000	●	Uten klesbeskyttere/armlen				
ZRS040109	□	Klesbeskytter med skjerm	(Ikke i kombinasjon med armlener, armlensfester eller 16" drivhjul. Ve & Hø)	82004007-001, -2		
ZRS040052	□	Høyde og dybdejusterbart armlen (33cm)	(Ikke i kombinasjon med klesbeskyttere eller spesial armlensfester. Ve & Hø)	067870-001, -2		
	□	Fester for høyde/dybdejust armlene (ZRS040052). Trenger 2stk.		82004008		
		Feste for spesial armlener til 15x15 mm firkantrør	(15 x 15 mm; sort)	82004202-000		
ZRS040124	□	Montert	ZRS040125	□	Ikke montert	(Art nr i par)

## KJØREHÅNDTAK

ZRS030206	●	Vinkel og høyderegulerbart kjørebøyle		
-----------	---	---------------------------------------	--	--

## Rygg

ZRS030012	●	Vinkel justerbar rygggramme	(90° - 120°; SD45 bare 90°-110°)								
<b>Justert til</b>											
ZRS030526	●	90°	ZRS030527	○	95°	ZRS030528	○	100°			
ZRS030529	○	105°	ZRS030531	○	110°	ZRS030532	○	115°	ZRS030533	○	120°
ZRS030014	□	Vinkelregulerbar rygggramme	(90° - 120° ; eller 85° - 115°)								
ZRS030105	□	Feste for rygg	(ikke i kombinasjon med Jay J3 eller ryggplate)								
ZRS030305	□	Ryggplate	(ikke i kombinasjon med Jay J3)								
ZRS030418	□	Hodestøtte	(inkl feste; ikke montert og ikke i kombinasjon med Jay J3 rygg)								
ZRS030420	□	Feste for spesial hodestøtter	(for 15 x 15 mm firkantrør, ikke montert)								

## JAY RYGGER OG TILBEHØR - for komplett oversikt, se Jay brosjyre og bestillingsskjema

### Jay J3 Rygg - Mid Contour (MC)

Mid Thoracic (MT):	□	JAY030011	Medium - 34 cm	□	JAY030018	Høy - 38 cm			
Upper Thoracic (UT):	□	JAY030013	Lav - 42 cm	□	JAY030020	Medium - 46 cm (1)	□	JAY030026	Høy - 50 cm (1)
Shoulder Height (SH):	□	JAY030016	Lav - 53 cm (1)	□	JAY030023	Medium - 57 cm (2)			

### Jay J3 Rygg - Deep Contour (DC)

Upper Thoracic (UT):	□	JAY030014	Lav - 42 cm (1)	□	JAY030021	Medium - 46 cm (1)	□	JAY030027	Høy - 50 cm (1)
Shoulder Height (SH):	□	JAY030017	Lav - 53 cm (1)	□	JAY030024	Medium - 57 cm (2)			

### Jay J3 Rygg - Posterior Deep Contour (PDC)

Upper Thoracic (UT):	□	JAY030031	Medium - 46 cm	
Shoulder Height (SH):	□	JAY030032	Lav - 53 cm (2)	<a href="#">Jay katalog</a> <a href="#">katalog for riktige art nr</a>

### JAY FIT RYGG

Setebredde:	□	30 cm	□	35 cm	□	40 cm				
Rygg høyde:	□	30 cm	□	35 cm	□	40 cm	□	45 cm	□	50cm
	□	Jay Fit fester	(Inngår i std Jay Fit rygg)							474302

### Jay J3 Hodestøtter

JAY030004	□	Jay flip back headrest (J3EUHDFH & J3EUHDLSP)	(bare med Jay J3 backs)
JAY030006	□	Jay standard headrest (J3EUHDXH & J3EUHDLSP)	(bare med Jay J3 backs)

### Withmyer Hodestøtter

Art nr:	<input type="text"/>	<a href="#">(Se katalog for art nr)</a>
---------	----------------------	-----------------------------------------

## Benstøtter og fotplater

ZRS050000	●	Uten benstøtter					
Benstøtter vinkelregulerbare							
ZRS050009	□	Venstre	ZRS050010	□	Høyre	(Andre siden med aluminium benstøtter inkl 7 cm abduksjon)	82005040-001, -2
ZRS050011	□	Par				(7 cm abduksjon begge sider)	82005040-000 (par)
Aluminium benstøtter 80°							
ZRS050006	□	Venstre	ZRS050007	□	Høyre	(Stk. Hø = Ve)	82005036
ZRS050008	□	Par				(7 cm abduksjon begge sider)	

### Fotplater

ZRS050022	□	Delte aluminium fotplater( farge som ramme)	(Vinkel og dybdejusterbar, Par, sb 30,35 & 40)	82005211-010, -020, -030
ZRS050045	□	Hel oppfellbar og vinkeljusterbart fotplate med hælstopper ( <b>kompl. hel benstøtte</b> )	(Setebredde 35 & 40)	82005202-001
		(Farge som ramme,; Rørdiameter: 15 x 15mm)	(Setebredde 45)	82005202-002

### Feste for benstøtter

ZRS050046	□	Montert	(Bare i kombinasjon med seteplate)	ZRS050047	□	Ikke montert	(15x15 mm firkantrør)	82005001-001, -2, -3
-----------	---	---------	------------------------------------	-----------	---	--------------	-----------------------	----------------------

(1) Bare SB 35 & 40 cm  
(2) Bare SB 40 cm

For mer informasjon  
besøk vår hjemmeside  
[www.SunriseMedical.no](http://www.SunriseMedical.no)  
© Sunrise Medical 2022

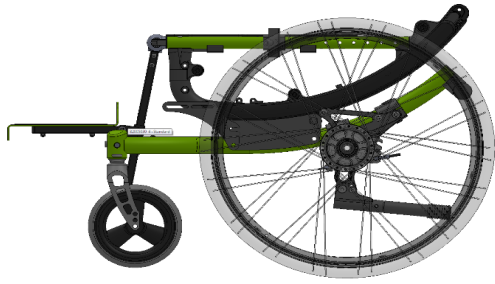

Vippestuss

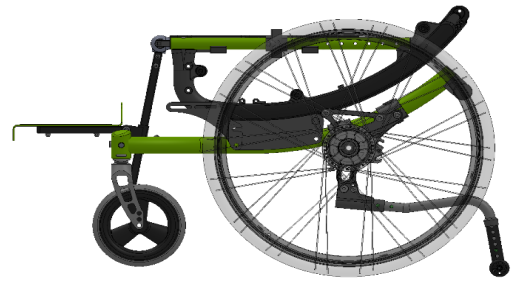

Tippesikring, oppfellbare

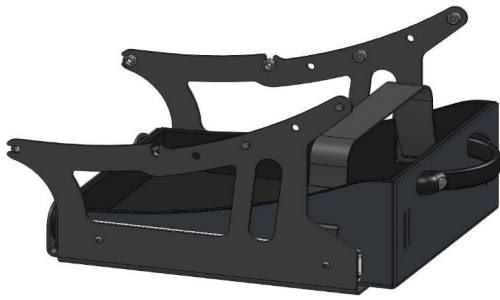

Oppebevaringsboks

### Dimensjoner på oppbevaringsboks

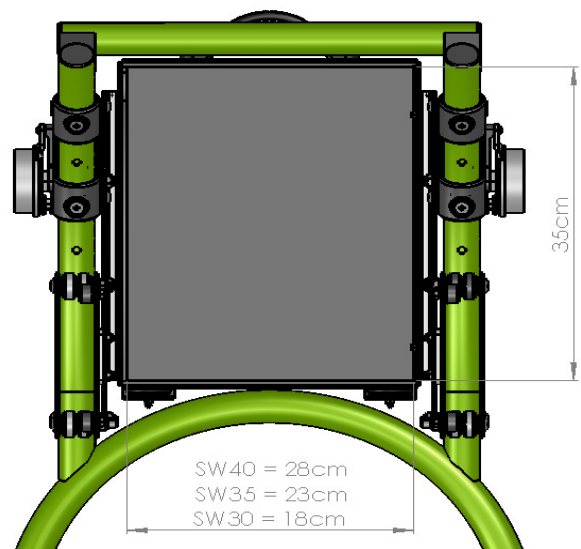
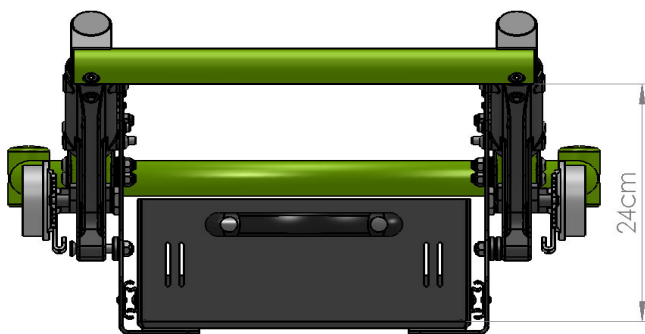

Zippie RS

● = Standard

○ =Uten tillegg i prisen

□ = Tillegg i prisen

Artikkelnummer

**Tilbehør**

ZRS090000	<input checked="" type="checkbox"/> Verktøysett		
	<input type="checkbox"/> Vippestuss (tippesikring og vippestuss kan ikke velges til samme side)		
ZRS090001	<input type="checkbox"/> Venstre	ZRS90002	<input type="checkbox"/> Høyre
ZRS090003	<input type="checkbox"/> Par		(ikke i kombinasjon med tippesikringer)
	<input type="checkbox"/> Tippesikring (tippesikring og vippestuss kan ikke velges til samme side)		
ZRS090042	<input type="checkbox"/> Venstre	ZRS090043	<input type="checkbox"/> Høyre
ZRS090044	<input type="checkbox"/> Par		(ikke i kombinasjon med vippestuss)
ZRS090070	<input type="checkbox"/> Oppbevaringsboks		(Bare i kombinasjon med tippesikringer, maks last 13 kg)
ZRS090011	<input type="checkbox"/> Bord "Slide-on"		(Kun sb40. Bare i kombinasjon med armlener)
			82009201 (hø/ve)
			82003202-001 (ve)
			82003202-002 (hø)
			82009204-001,-2,-3
			760848050.01

**Farger**

	Ramme	Drivring		Ramme	Drivring
02 Brilliant Silver	<input type="checkbox"/>	<input type="checkbox"/>	29 Black	<input type="checkbox"/>	<input type="checkbox"/>
03 Silver Matt	<input type="checkbox"/>	<input type="checkbox"/>	31 Matt Black	<input type="checkbox"/>	<input type="checkbox"/>
06 Sun Yellow	<input type="checkbox"/>	<input type="checkbox"/>	32 Signal White	<input type="checkbox"/>	<input type="checkbox"/>
14 Blue	<input type="checkbox"/>	<input type="checkbox"/>	33 Pink	<input type="checkbox"/>	<input type="checkbox"/>
15 Brilliant Marine	<input type="checkbox"/>	<input type="checkbox"/>	34 Dark Chocolate Metallic	<input type="checkbox"/>	<input type="checkbox"/>
16 Matt Marine	<input type="checkbox"/>	<input type="checkbox"/>	35 Skyblue	<input type="checkbox"/>	<input type="checkbox"/>
19 Brilliant Purple	<input type="checkbox"/>	<input type="checkbox"/>	36 Cyan-Metallic	<input type="checkbox"/>	<input type="checkbox"/>
21 Red Ruby	<input type="checkbox"/>	<input type="checkbox"/>	37 Marsred (Orange)	<input type="checkbox"/>	<input type="checkbox"/>
22 Brilliant Red	<input type="checkbox"/>	<input type="checkbox"/>	40 Kiwi	<input type="checkbox"/>	<input type="checkbox"/>
23 Matt Red	<input type="checkbox"/>	<input type="checkbox"/>	41 Flamingo-Glitter	<input type="checkbox"/>	<input type="checkbox"/>
24 Tutti Frutti Orange	<input type="checkbox"/>	<input type="checkbox"/>	42 Matt-Anthracite	<input type="checkbox"/>	<input type="checkbox"/>
27 Graphitemetallic	<input type="checkbox"/>	<input type="checkbox"/>	46 Mamba Green (new)	<input type="checkbox"/>	<input type="checkbox"/>

**Kommentarer for individuelle tilpasninger**

Sunrise Medical AS v/Kundeservice  
 Adresse: Delitoppen 3, 1540 Vestby  
 T. 66963800

E-mail: [mailordre@sunrisemedical.no](mailto:mailordre@sunrisemedical.no)

Website: [www.sunrisemedical.no](http://www.sunrisemedical.no)



[www.SunriseMedical.no](http://www.SunriseMedical.no)

© Sunrise Medical 2022