



Deliver to:  
 Name: \_\_\_\_\_  
 Street: \_\_\_\_\_  
 Town: \_\_\_\_\_ Postal code: \_\_\_\_\_  
 E-Mail: \_\_\_\_\_  
 Tel: \_\_\_\_\_ Fax: \_\_\_\_\_

Deliver to:  
 Name: \_\_\_\_\_  
 Street: \_\_\_\_\_  
 Town: \_\_\_\_\_ Postal code: \_\_\_\_\_  
 E-Mail: \_\_\_\_\_  
 Tel: \_\_\_\_\_ Fax: \_\_\_\_\_

Order date: \_\_\_\_\_  
 Purchase order: \_\_\_\_\_  
 Number required: \_\_\_\_\_



Marked for:  
 Sunrise order no: \_\_\_\_\_

- Order
- Calculation
- Built 4 me

- = Standard      □ = Cost option
- L = Extended delivery time      ○ = No cost option

Reimbursement code:

Art. no.: 843900001-000

**Customer service fax number**

**Max. user weight: 85 kg**

**USER WEIGHT**  kg

Mandatory information to ensure correct configuration

Please consult our colour catalogue, to review your colour choice at the end of the order form

**Basic price €**

**CLIENT MEASUREMENT**

		Seat width in mm									
		220	240	260	280	300	320	340	360	380	400
Seat depth in mm	240	○	○	○	○	○	○	○	○	○	○
	260	○	○	○	○	○	○	○	○	○	○
	280	○	○	○	○	○	○	○	○	○	○
	300	○	○	○	○	○	○	○	○	○	○
	300	○	○	○	○	○	○	○	○	○	○
	320	○	○	○	○	○	○	○	○	○	○
	340	○	○	○	○	○	○	○	○	○	○
	360	○	○	○	○	○	○	○	○	○	○
	380	○	○	○	○	○	○	○	○	○	○
	400	○	○	○	○	○	○	○	○	○	○

+40cm      Straight frame starting at 260 mm

Your rear seat height can only be between 0 mm and 120 mm below your front seat height:  
 i.e. rear seat height CANNOT be above front seat height  
 i.e. rear seat height CANNOT be more than 120 mm below front seat height  
 - More info, see first back page  
 4" & 5" solid, 4" & 5" soft roll and 5" & 6" soft solid are only available with 45 mm fork

		Front seat height in mm												
		fork (length x width)												
		370	380	390	400	410	420	430	440	450	460	470	480	500
Front Castor	4"	111 mm x 45 mm		○	○	○	○							
		115 mm x 45 mm (3)			○	○	○	○						
		111 mm x 32 mm	○	○	○	○	○							
		131 mm x 45 mm (1) (3)					○	○	○	○				
		166 mm x 45 mm (1) (2) (3)							○	○		○	○	
	5"	111 mm x 45 mm				○	○	○						
		115 mm x 45 mm (3)					○	○	○					
		111 mm x 32 mm				○	○	○						
		131 mm x 45 mm (1) (3)						○	○	○	○			
		166 mm x 45 mm (1) (2) (3)								○	○	○	○	○
	6"	111 mm x 45 mm						○	○					
		115 mm x 45 mm (3)						○	○	○				
131 mm x 45 mm (1) (3)							○	○	○	○				
166 mm x 45 mm (1) (2) (3)									○	○	○	○	○	

		Rear seat height in mm														
		320	330	340	350	360	370	380	400	410	420	430	440	450	460	470
Rear wheels	20" (4)			○	○											
	22"					○	○	○	○	○		○	○	○		
	24"								○	○	○	○	○	○		○

**Lightweight Package**      YNG090600  
*incl. Proton wheel and lightweight sideguard*  
 regular price 447,- -> saving to regular ordering is 60,-

**Safari Package**      YNG090601  
*incl. Aluminium sideguard with fender (YNG040212) and Safari wheel lock (YNG060105)*  
 regular price 367,- -> saving to regular ordering is 61,-

- Please note the procedure of the measurement is from the back  
 - All measurements are in mm and without a cushion

- (1) only aluminium fork available
- (2) only grey available
- (3) fork compatible with additional drive
- (4) only Proton wheels/Right Run tyres

**Please follow measuring method:**

The following method is recommended on the basis of extensive practical experience. Deviations are possible in individual instances

**Seat width:**

**a) For the user:**

Allow space of sideguard to pass vertically between hip and sideguard on each side (approx. 10 - 20 mm altogether)

**b) On the wheelchair:**

From outside frame tube to outside frame tube

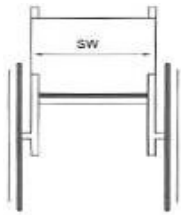

**Seat depth:**

**a) For the user:**

When sitting upright: leave space for 2-3 fingers between front edge of seat upholstery and back of knee (approx. 30 - 60 mm). Care must be taken with adjustable upholstery

**b) On the wheelchair:**

From back tube to front of seat upholstery



**Back height:**

**a) For the user:**

Measured from the seat, including cushion, to **no more** than one finger (10 - 20 mm) below the lower shoulderblade.

**Important!** The back height depends on the degree of disability

**b) On the wheelchair:**

From seat tube to upper edge of backrest upholstery.

**Note:** The user's ability to sit upright has a major influence on the back height and it can therefore differ considerably



**Lower leg length:**

**a) For the user:**

With legs angled at right angles, from back of knee to bottom of shoe sole

**b) On the wheelchair:**

From front of seat to top of footrest.

**Remember:** to include the cushion height

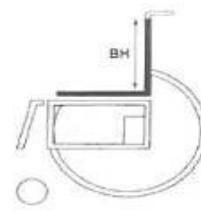

**Overall width:**

Max. Width 700 mm  
Max. Height 920 mm  
Max. Length 930 mm

**Weights:**

Minimum weight: from 8.5 kg

**Folded size:**

Minimum width: ca. 310 mm

**NOTES:**

Max. seat height difference rear to front is 120 mm  
No negative seat angle is possible  
Manufacturing tolerances of +/- 10 mm

Product is crash tested according to ISO 7176-19 and therefore approved for transportation in a vehicle.  
For transport without a user the chair must be safe clamped in the vehicle.

# Zippie Youngster 3

● = Standard    ○ = No cost option    □ = Cost option

R. Nr.    €

## SEAT UPHOLSTERY

### Seat sling

YNG020101	<input type="radio"/>	1 Utility bag		
YNG020102	<input type="checkbox"/>	With two utility bags	<i>(only from SW 340 mm)</i>	
YNG020103	<input type="checkbox"/>	One utility bag and one catheter bag	<i>(only from SW 340 mm)</i>	
YNG020104	<input type="radio"/>	Without seat sling		
<b>For JAY Seating, see Jay order form</b>				

### Seat cushion with cover, black

a) Foam composite	Thickness: YNG020201	<input type="checkbox"/>	30mm YNG020203	<input type="checkbox"/>	50mm	<i>(medium)</i>		
-------------------	----------------------	--------------------------	----------------	--------------------------	------	-----------------	--	--

### Seat accessories

YNG020301	<input type="checkbox"/>	Positioning belt with lock		
YNG020303	<input type="checkbox"/>	JAY Fit belt 90° attachment	<i>(attached to the seat rail)</i>	<i>(starts with SW 260; use with cushion only)</i>
YNG020304	<input type="checkbox"/>	JAY Fit belt 45° attachment	<i>(attached to the seat rail)</i>	<i>(starts with SW 260; use with cushion only)</i>
YNG020305	<input type="checkbox"/>	Seat plate (for mounting of seat shell adapters, build in growth)		<i>(only from SW 240 mm)</i>

Backrest (range)	225 - 275	275 - 325	325 - 375	375 - 425
Back height set at (cm)	<input type="radio"/> 225	<input type="radio"/> 275	<input type="radio"/> 325	<input type="radio"/> 375
	<input type="radio"/> 250	<input type="radio"/> 300	<input type="radio"/> 350	<input type="radio"/> 400
	<input type="radio"/> 275	<input type="radio"/> 325	<input type="radio"/> 375	<input type="radio"/> 425

## BACKREST

### Backrest frame

YNG030101	<input type="radio"/>	Standard: Non angle adjustable (90°), non folding backrest		
YNG030102	<input type="checkbox"/>	Angle adjustable	<i>(Only in combination with sideguard YNG040202)</i>	
		<input type="checkbox"/> 87° <input type="checkbox"/> 90° <input type="checkbox"/> 95° <input type="checkbox"/> 100° <input type="checkbox"/> 105°		
<b>Build for me on!</b>	<input type="checkbox"/>	Build for me Option: Reclining back		
<b>Additional lead time 10 days</b>		Infinite back recline from -3° to +20°	<b>(1)</b>	<i>(only in combination with sideguard YNG040202)</i>

### Pushhandles

YNG030201	<input type="radio"/>	Without pushhandles		
YNG030203	<input type="radio"/>	long		
YNG030204	<input type="checkbox"/>	Fold-down pushhandles	<i>(only up from BH 350 mm)</i>	
YNG030205	<input type="checkbox"/>	Height-adjustable pushhandles	<i>(only up from BH 250 mm)</i>	
YNG030206	<input type="checkbox"/>	Height-adjustable pushhandles side angled	<i>(not in combination with drumbrakes)</i>	
YNG030207	<input type="checkbox"/>	JAY Hardware with height adj. pushhandles	<i>(only up from BH 300 mm)</i>	
YNG030208	<input type="checkbox"/>	JAY Hardware with height adj. PH side angled		

### Backrest upholstery

	<input type="radio"/>	Standard backrest upholstery		
YNG030316	<input type="radio"/>	EXO Backrest sling, padded, adjustable, 1 accessory bag, black <b>(EXO Evo version)</b>		
		Colour, binding tape: <input type="radio"/> Black <input type="radio"/> Orange <input type="radio"/> Silver <input type="radio"/> Red <input type="radio"/> Blue		
YNG030317	<input type="checkbox"/>	EXO PRO Backrest, padded, adj., breathable spacer fabric, 1 accessory bag, black <b>(EXO Evo version)</b>		
		Colour, binding tape: <input type="radio"/> Black <input type="radio"/> Orange <input type="radio"/> Silver <input type="radio"/> Red <input type="radio"/> Blue		
YNG030305	<input type="checkbox"/>	Without back upholstery		

### Headrest

YNG030401	<input type="checkbox"/>	medium YNG030402	<input type="checkbox"/>	large		
YNG030403	<input type="checkbox"/>	Stabiliser bar				

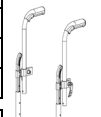

YNG030205

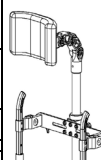

YNG030401

**(1): not in combination with Safari wheel lock; Seat depth enlargement (50 mm); Standard backrest upholstery**

For more information  
[www.sunrisemedical.eu](http://www.sunrisemedical.eu)  
 © Sunrise Medical 2025

### YOUNGSTER 3 Seat heights and lower leg length

#### Seat height matrix - front seat height (in mm)

	Fork Position	Caster size		
		4"	5"	6"
		Fork (32/111 mm)	2	400
	1	410	420	X
Fork (45/111 mm)	3	390	X	X
	2	400	410	X
	1	410	420	430
Fork (45/115 mm)	3	400	410 <sup>1</sup>	X
	2	410	420	430
	1	420	440	450
Fork (45/131 mm)	3	420	430	430
	2	430	440	450
	1	440	450	460
Fork (45/166 mm)	4	X	450	460
	3	440	460	470
	2	460	470	480
	1	470	480	500

**Details:**

- \* SH-details with 10 mm spacer between fork and frame - spacer could be mounted underneath the fork => reduced SH - 10 mm
- \* without cushion
- \* without seat angle (0°)
- \* X = No Go
- <sup>1</sup> Not available with 5" soft rolls

#### Seat height back (in mm) with rear wheels 20", 22" and 24"

	Axle plate position	rear wheel size		
		20"	22"	24"
8	8	320	355	X
7	7	330	37	X
6	6	350	380	410
5	5	X	400	425
4	4	X	415	435
3	3	X	430	445
2	2	X	440	455
1	1	X	455	470

**Details**

- \* measurements made with 1". \* without seat angle (0°)
- \* without cushion
- \* X = No Go
- \* without camber (0°)

#### Distance between seat and handrim (outside tube)

	Axle plate position	rear wheel size		
		20"	22"	24"
8	8	125	140	X
7	7	110	130	X
6	6	100	115	145
5	5	X	100	130
4	4	X	90	120
3	3	X	80	105
2	2	X	65	95
1	1	X	50	80

**Details**

- \* without cushion
- \* X = No Go
- \* without camber (0°)

#### Y3-LLL matrix; platform footrest, angle adjustable

	Fork position	4"-Caster		5"-Caster		6"-Caster	
		min. LLL	max. LLL	min. LLL	max. LLL	min. LLL	max. LLL
Fork 111 mm	3	300	340	X	X	X	X
	2	300	350	X	X	X	X
	1	300	360	X	X	X	X
Fork 115 mm	3	300	350	X	X	X	X
	2	300	360	X	X	X	X
	1	300	380	300	390	X	X
Fork 131 mm	3	300	360	X	X	X	X
	2	300	380	300	390	X	X
	1	300	390	300	400	X	X
Fork 166 mm	4	X	X	300	400	X	X
	3	300	400	300	410	300	340
	2	300	410	300	430	300	430
	1	300	420	300	440	300	450

Zippie Youngster 3		R. Nr.	€
● = Standard    ○ = No cost option    □ = Cost option			
<b>ARMREST AND SIDEGUARDS</b>			
<b>Armrest</b>			
YNG040101	<input type="checkbox"/> Armrest height adjustable, short, screw-on	<i>(only with YNG040201, YNG040202 and YNG040211)</i>	
<b>Sideguards</b>			
YNG040201	<input type="checkbox"/> Straight sideguard aluminium with cloth protection		
YNG040202	<input type="checkbox"/> Aluminium sideguard for angle adjustable back at fixed angles with cloth protection		
YNG040204	<input type="checkbox"/> Fender, composite, screw-on, black	<i>(only with YNG040201 and YNG040202)</i>	
YNG040210	<input type="checkbox"/> Mud guard (fender - covers the complete wheel)	<i>(only with YNG040201 and YNG040202)</i>	
YNG040203	<input type="checkbox"/> Lightweight carbonfibre look sideguard with integrated clothing guard	<b>(1)</b>	
YNG040211	<input type="checkbox"/> Straight sideguard aluminium with fender (Pair) - Tool height adj armrest possible		
YNG040212	<input type="checkbox"/> Straight sideguard aluminium with fender (Pair) for Safari wheel lock		
YNG040205	<input type="checkbox"/> Plastic sideguards detachable (Quickie style)		
<b>Sideguards options and accessories</b>			
YNG040206	<input type="checkbox"/> Height adjustable tray table, slide-on for SW 220 - 360 mm not SW 380 & 400 mm		
Therapy table flip-down for SW 260 - 400 mm			
Attachment: YNG040207 <input type="checkbox"/> right-hand    YNG040208 <input type="checkbox"/> left-hand			
<b>LEGREST &amp; FOOTPLATES</b>			
Platform footrest, angle adjustable (only in footplate position 3 - back page 2)			
YNG050102	<input type="checkbox"/> Composite board	<i>(Abdu frame SW 260 - 400; Std 300 - 400)</i>	
YNG050103	<input type="checkbox"/> Carbon board	<i>(Abdu frame SW 280 - 400, Std 320 - 400)</i>	
YNG050115	<input type="checkbox"/> Foot positioning plate		
YNG050106	<input type="checkbox"/> Platform footrest "Youngster 3"	<i>(SW 380 &amp; 400 with abduction is supplied w aluminium board)</i>	
YNG050107	<input type="checkbox"/> Locking system for spasticity for platform footrest		
YNG050108	<input type="checkbox"/> Swing Away mechanism	<i>(not with Platform footrest, angle adjustable)</i>	
YNG050111	<input type="checkbox"/> Divided footplate "Youngster 3" - composite	<i>(not in SW 220 mm)</i>	
Locking system for spasticity for divided footrest			
YNG050112	<input type="checkbox"/> Right attachement		
YNG050113	<input type="checkbox"/> Left attachement		
YNG050114	<input type="checkbox"/> Lock for divided footrest (Right and left)		
YNG050101	<input type="checkbox"/> Divided footplate Alu "Youngster3"	<i>(starts w abdu frame SW 260, Std SW 300 mm)</i>	
Clamp for platform footrest "Youngster3"		<input type="checkbox"/> Short (90 mm) <input type="checkbox"/> Long (121 mm)	
	YNG050116	YNG050117	
<b>Lower leg length (LLL) (in mm)</b>			
○ 110    ○ 120    ○ 130    ○ 140    ○ 150    ○ 160    ○ 170    ○ 180			
○ 190    ○ 200    ○ 210    ○ 220    ○ 230    ○ 240    ○ 250    ○ 260			
○# 280    ○ 290    ○ 300    ○ 310    ○ 320    ○ 330    ○ 340    ○ 350			
○# 370    ○ 380    ○ 390    ○ 400    ○ 410    ○ 420    ○ 430    ○ 440			
<b>FRAME (with smart and nice folding fixation and frame protection for the rear frame end and the axle plate)</b>			
YNG010101	<input type="radio"/> Standard folding frame (straight)	<i>(from SW 260 - 400 mm)</i>	
YNG010102	<input type="radio"/> Abduction folding frame	<i>(from SW 220 - 400 mm)</i>	
<b>Seat depth enlargement (50 mm)</b> <i>(from SD 300 mm)</i>			
YNG010201	<input type="checkbox"/> Seat depth enlargement (50 mm) <b>(2) (3) (4)</b>		
Increases seat depth by 50 mm allowing better COG adjustment when used in combination with seat shells		<i>(only in combination with adjustable upholstery)</i>	
<b>(1): not with combination cloth protection, armrest &amp; plastic sideguard</b>		For more information visit our webpage <a href="http://www.sunrisemedical.eu">www.sunrisemedical.eu</a> © Sunrise Medical 2025	
<b>(2): not with Safari wheel-lock</b>			
<b>(3): only with YNG040201 &amp; YNG040202</b>			
<b>(4): not with mud guard</b>			

**Y3-Platform footrest "Youngster 3" style**

Footplate position 1	Fork position	4"-Castor				5"-Castor				6"-Castor			
		Clamp short		Clamp long		Clamp short		Clamp long		Clamp short		Clamp long	
		min. LLL	max. LLL	min. LLL	max. LLL	min. LLL	max. LLL	min. LLL	max. LLL	min. LLL	max. LLL	min. LLL	max. LLL
Fork 111 mm	3	150	260	120	290	X	X	X	X	X	X	X	X
	2	150	260	120	290	150	260	120	29	X	X	X	X
	1	150	260	120	290	150	260	120	29	150	260	120	290
Fork 115 mm	3	150	260	120	290	150	260	120	29	150	260	X	X
	2	150	260	120	290	150	260	120	29	150	260	120	290
	1	150	260	120	290	150	260	120	29	150	260	120	290
Fork 131 mm	3	150	260	120	290	150	260	120	29	150	260	120	290
	2	150	260	120	290	150	260	120	29	150	260	120	290
	1	150	260	120	290	150	260	120	29	150	260	120	290
Fork 174 mm	4	150	X	X	X	150	260	120	29	150	260	120	290
	3	150	260	120	290	150	260	120	29	150	260	120	290
	2	150	260	120	290	150	260	120	29	150	260	120	290
	1	150	26	120	290	15	260	120	29	150	260	120	290

Footplate position 2	Fork position	4"-Castor				5"-Castor				6"-Castor			
		Clamp short		Clamp long		Clamp short		Clamp long		Clamp short		Clamp long	
		min. LLL	max. LLL	min. LLL	max. LLL	min. LLL	max. LLL	min. LLL	max. LLL	min. LLL	max. LLL	min. LLL	max. LLL
Fork 111 mm	3	140	240	110	260	X	X	X	X	X	X	X	X
	2	140	240	110	260	140	240	110	260	X	X	X	X
	1	140	240	110	260	140	240	110	260	140	240	110	260
Fork 115 mm	3	140	240	110	260	140	240	110	260	140	240	X	X
	2	140	240	110	260	140	240	110	260	140	240	110	260
	1	140	240	110	260	140	240	110	260	140	240	110	260
Fork 131 mm	3	140	240	110	260	140	240	110	260	140	240	110	260
	2	140	240	110	260	140	240	110	260	140	240	110	260
	1	140	240	110	260	140	240	110	260	140	240	110	260
Fork 174 mm	4	140	X	X	X	140	240	110	260	140	240	110	260
	3	140	240	110	260	140	240	110	260	140	240	110	260
	2	140	240	110	260	140	240	110	260	140	240	110	260
	1	140	240	110	260	140	240	110	260	140	240	110	260

Footplate position 3	Fork position	4"-Castor				5"-Castor				6"-Castor			
		Clamp short		Clamp long		Clamp short		Clamp long		Clamp short		Clamp long	
		min. LLL	max. LLL	min. LLL	max. LLL	min. LLL	max. LLL	min. LLL	max. LLL	min. LLL	max. LLL	min. LLL	max. LLL
Fork 111 mm	3	250	360	220	360	X	X	X	X	X	X	X	X
	2	250	370	220	370	250	350	220	380	X	X	X	X
	1	250	380	220	380	250	370	220	390	X	X	X	X
Fork 115 mm	3	250	370	220	350	250	350	220	380	X	X	X	X
	2	250	380	220	360	250	370	220	400	250	350	220	380
	1	250	390	220	390	250	410	220	410	250	360	220	400
Fork 131 mm	3	250	360	220	390	250	360	220	400	250	350	220	380
	2	250	400	220	400	250	400	220	410	250	370	220	400
	1	250	410	220	420	250	410	220	420	250	390	220	420
Fork 174 mm	4	X	X	X	X	250	420	220	420	250	380	220	420
	3	250	420	220	420	250	430	220	430	250	410	220	440
	2	250	430	220	430	250	440	220	440	250	450	220	450
	1	250	440	220	440	250	460	220	460	250	470	220	470

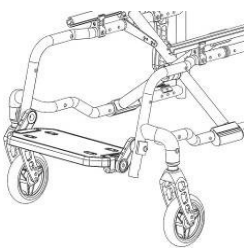

Footplate position 1

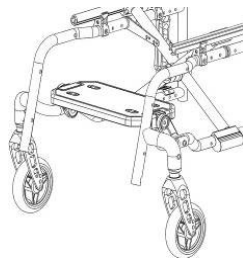

Footplate position 2

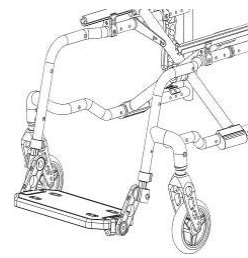

Footplate position 3

# Zippie Youngster 3

● = Standard    ○ = No cost option    □ = Cost option

R. Nr.

€

## FRAME ACCESSORIES

(choose either tip assist or anti-tip tubes, not both)

### Tip assist (step tube)

YNG010301  Left  YNG010302 Right

YNG010305  Pair

YNG010303  Crutch holder with Velcro (only in combination with tip assist)

### Anti-tip tubes, swing-away

Anti-tip tubes, swing-away

YNG010306 Left YNG010307  Right

YNG010308 Pair

YNG010309  Transit wheel (not with anti-tip and tip assist)

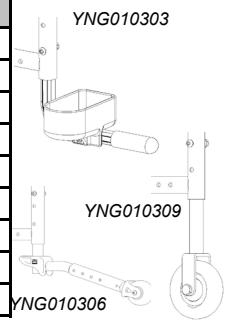

## PREPARATION FOR ATTITUDE ADD-ON BIKE (4)

YNG090911  Preparation for ATTITUDE, without ATTITUDE order (4) (docking pins assembled)

YNG090912  Preparation for ATTITUDE, with ATTITUDE order (4) (docking pins assembled; separate ATTITUDE order)

## EMPULSE M90 BUNDLING

EMO000501  With M90 order, not mounted to the wheelchair (Please use separate OF to order the M90, Only with 24" wheel, Only with 0° Camber, Not compatible with Drum Brake Option)

EMO000502  With M90 order, mounted to the wheelchair (Please use separate OF to order the M90, Only with 24" wheel, Only with 0° Camber, Not compatible with Drum Brake Option)

## FORK

(compare with your choice on the first page)

Fork Carbotecture® (only 111 mm)

Fork Aluminum

## STANDARD CASTOR

(compare with your choice on the first page)

YNG080201  Solid (for 45 mm fork version only) (only for 4" & 5")

YNG080202  Soft solid (for 45 mm fork version only) (only for 5" & 6")

### Light ups

YNG080203  Solid (not available for 6")

### Castor with aluminium rim

YNG080204  Solid (only for 4" & 5")

YNG080205  Soft roll (for 45 mm fork version only) (only for 4" & 5")

## REAR WHEELS

YNG070110  without rear wheels

YNG070101  Straight spoked (only 22")

YNG070102  Universal cross spoked (pair) (only 22" & 24")

YNG070103  Design wheel (pair) (only 24")

YNG070104  Light weight wheel (2) (pair) (only 22" & 24")

YNG070105  Proton wheel (2) (pair)

YNG070111  Drumbrake (for care person, quick-release axle) (only 22" & 24")

YNG070106  Mountain Bike wheel (only with 24", mountainbike tyres & aluminium rim, black coated)

YNG070107  Additional mountainbike wheel (only with 24" & mountainbike tyres)

One arm drive with quick-release axle, one-arm brake not included (3)

YNG070108  Left YNG070109  Right

## TYRES

(choose only one tyre type)

YNG070201  Right Run

YNG070202  Solid tyres (1) (only 22" & 24")

YNG070112  Schwalbe One (only 24")

YNG070205  Marathon plus evolution (puncture proof) (only 24")

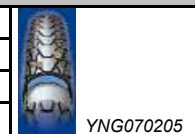

YNG090163  Spares-kit: 1 extra tyre (same as on the chair) and 1 extra inner tube (not with solid tyres)

# Zippie Youngster 3

● = Standard    ○ = No cost option    □ = Cost option

R. Nr.

€

## HANDRIM

YNG070301	<input type="radio"/> Aluminium silver anodized	(2)		
YNG070302	<input type="radio"/> Aluminium silver powdercoated	(2)		
YNG070303	<input type="checkbox"/> Coloured aluminium powder coated. colour code: .....			
YNG070304	<input type="radio"/> Stainless steel	(only 22" & 24")		
YNG070305	<input type="checkbox"/> Titanium	(only 22" & 24")		
YNG070306	<input type="checkbox"/> Titanium clear powdercoated	(only 22" & 24")		
YNG070307	<input type="checkbox"/> Supergrip	(only 22" & 24")		
YNG070308	<input type="checkbox"/> Maxgrepp	(only 22" & 24")		
Hand rim mounting YNG070401 Standard = 17 mm				
(Not with Maxgrepp)				
YNG070403 <input type="checkbox"/> Close = 7 mm				
less steel; not in combination with Spinergy, Proton and Lightweight Wheels and stainless steel Handrim, Not with Maxgrepp)				
YNG070402 <input type="radio"/> Wide = 27 mm				
YNG070309	<input type="checkbox"/> Handrim cover	(only 22" & 24")		

## WHEEL CAMBER

(choose only one option)

YNG070501	<input type="radio"/> 0°			
YNG070502	<input type="radio"/> 1°			
YNG070503	<input type="radio"/> 2°			
YNG070504	<input type="radio"/> 3°			
YNG070505	<input type="radio"/> 4°			

## QUICK RELEASE AXLE

YNG070506	<input type="radio"/> Std			
YNG070507	<input type="checkbox"/> Quad			

## SPOKE GUARDS

(available in 22" & 24")

YNG070601	<input type="checkbox"/> Transparent	(available in 20", 22" and 24")		
YNG070614	<input type="checkbox"/> Galactica	YNG070630	<input type="checkbox"/> Chrome wheel	
YNG070604	<input type="checkbox"/> Princess	YNG070626	<input type="checkbox"/> Jungle Fever	
YNG070605	<input type="checkbox"/> Happy Lions	YNG070617	<input type="checkbox"/> Pirates	
YNG070606	<input type="checkbox"/> Monkeys	YNG070628	<input type="checkbox"/> Feather	
YNG070607	<input type="checkbox"/> Oriental	YNG070619	<input type="checkbox"/> Graffiti	
YNG070608	<input type="checkbox"/> Superhero	YNG070620	<input type="checkbox"/> Basketball	
YNG070609	<input type="checkbox"/> Hot wheels	YNG070631	<input type="checkbox"/> Basketball 2	
YNG070610	<input type="checkbox"/> Pool	YNG070621	<input type="checkbox"/> Flying water	
YNG070611	<input type="checkbox"/> Silk	YNG070632	<input type="checkbox"/> Space	
YNG070612	<input type="checkbox"/> Tiger	YNG070623	<input type="checkbox"/> Zebra	

(see spokeguard brochure)

## WHEEL LOCKS

(choose only one option)

YNG060101	<input type="radio"/> Standard wheel lock			
Knee lever wheel lock				
YNG060104	<input type="checkbox"/> inwards	YNG060102	<input type="checkbox"/> outwards	
YNG060105	<input type="checkbox"/> Safari wheel lock (wheel lock integrated into sideguard)			
YNG060106	<input type="checkbox"/> Attendant wheel lock with Safari wheel lock (only with YNG060105)			
YNG060107	<input type="checkbox"/> Drumbrake (for care person, quick-release axle) (only 22" & 24")			
<b>Wheel lock accessories</b>				
YNG060201	<input type="checkbox"/> Extension for knee lever wheel lock, slip-on, swing-away (only on kneelever whl)			

(1): not with Lightweight and Proton

(2): not with handrim mounting wide for Lightweight and Proton wheels

(3): no colour coat, no camber adjustment, no drum brakes. Only with cross-spoked rear wheel available min. SW = 279

(4): not with short frame in combination with 24" wheels, not with knee-lever wheel-lock

For more information

[www.sunrisemedical.eu](http://www.sunrisemedical.eu)

© Sunrise Medical 2025

**ARMREST AND SIDEGUARDS**

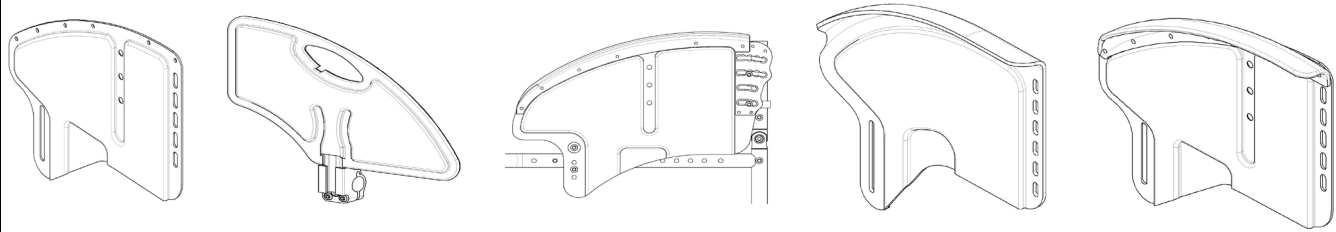

YNG040201

YNG040205

YNG040202

YNG040203

YNG040204

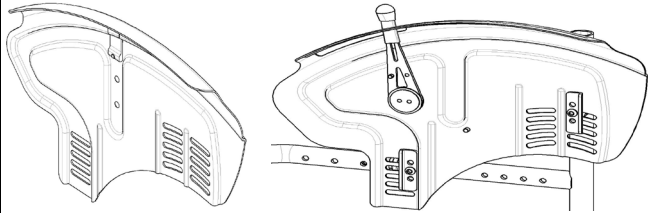

YNG040211

YNG040212

**LEGREST & FOOTPLATES**

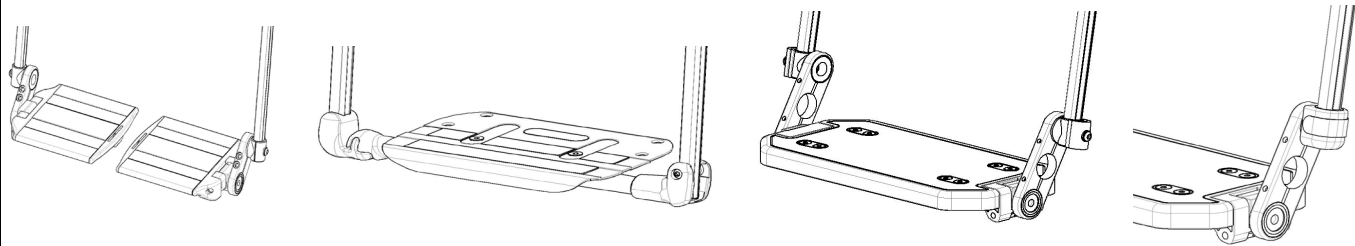

YNG050101

YNG050102 / YNG050103

YNG050106

YNG050108

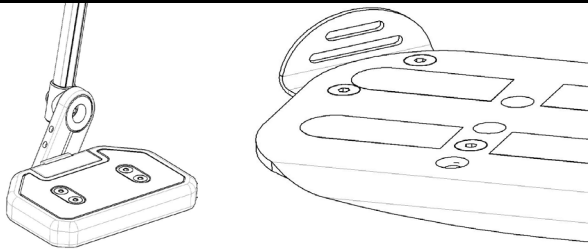

YNG050111

YNG050115

**WHEEL LOCKS**

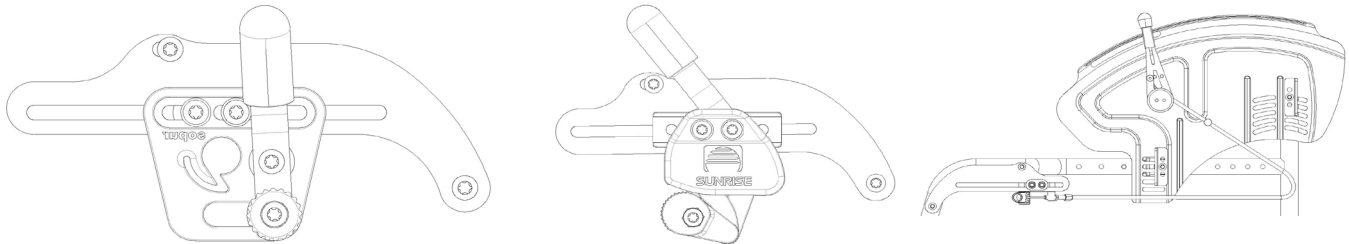

YNG06010

YNG060102

YNG060105

**FRAME**

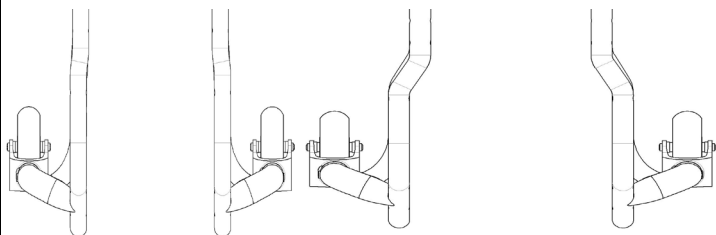

YNG010101

YNG010102

**BACKREST**

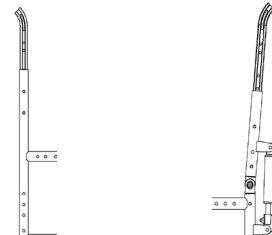

YNG030101

R4me

**SEAT DEPTH GROWTH**

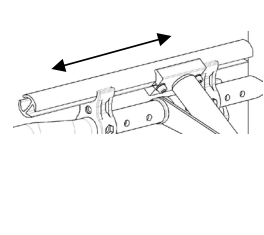

YNG010201

## Zippie Youngster 3

● = Standard    ○ = No cost option    □ = Cost option

R. Nr.	€
--------	---

### ACCESSORIES

<input type="radio"/> Tool kit				 YNG090106
YNG090101 <input type="checkbox"/> High pressure pump				
YNG090102 <input type="checkbox"/> Air pump				
YNG090103 <input type="checkbox"/> Back pack				
YNG090107 <input type="checkbox"/> Mobile phone bag				

### COLOURS

	Frame	Handrim	Hub/rim		Frame	Handrim	Hub/rim
01 Matte Black	<input type="radio"/>	<input type="checkbox"/>	<input type="checkbox"/>	12 Royal Blue	<input type="radio"/>	<input type="checkbox"/>	<input type="checkbox"/>
02 Gloss Black	<input type="radio"/>	<input type="checkbox"/>	<input type="checkbox"/>	13 Brilliant Ocean	<input type="radio"/>	<input type="checkbox"/>	
03 Metallic Shadow	<input type="radio"/>	<input type="checkbox"/>		14 Scarlet Noir	<input type="radio"/>	<input type="checkbox"/>	
04 Starlight White	<input type="radio"/>	<input type="checkbox"/>		15 Red Pepper	<input type="radio"/>	<input type="checkbox"/>	<input type="checkbox"/>
05 Silver Ore	<input type="radio"/>	<input type="checkbox"/>		16 Cherry Lustre	<input type="radio"/>	<input type="checkbox"/>	<input type="checkbox"/>
06 Storm Gray	<input type="radio"/>	<input type="checkbox"/>		17 Turbo Green	<input type="radio"/>	<input type="checkbox"/>	
07 Desert Tan	<input type="radio"/>	<input type="checkbox"/>		18 Pink Power	<input type="radio"/>	<input type="checkbox"/>	
08 Desert Sage	<input type="radio"/>	<input type="checkbox"/>		19 Satin Rose	<input type="radio"/>	<input type="checkbox"/>	
09 Salute Green	<input type="radio"/>	<input type="checkbox"/>		20 Mystic Purple	<input type="radio"/>	<input type="checkbox"/>	
10 Velvet Sapphire	<input type="radio"/>	<input type="checkbox"/>		21 Solar Orange	<input type="radio"/>	<input type="checkbox"/>	
11 Midnight Blue	<input type="radio"/>	<input type="checkbox"/>		22 Velocity Yellow	<input type="radio"/>	<input type="checkbox"/>	

### Anodized colour package for fork and axle plate

YNG090507	Silver Matt	<input type="checkbox"/>	
YNG090509	Black	<input type="radio"/>	

### FRAME STICKER

YNG100550	Black	<input type="radio"/>	-
YNG100551	Silver	<input type="checkbox"/>	€

**Comments for special build** - please apply for a quote; lead time conditions may change.



### Zippie Youngster 3 - Basic Price

Option price	€
Share of Packaging	€
Exclusive VAT	
VAT	
<b>Total Price</b>	€

Sunrise Medical Customer service

Address:	E-mail:	
Tel.	E-commerce:	
Fax.	Website:	

© Sunrise Medical 2025