

MONTERINGSANVISNING

Anatomiskt grepp

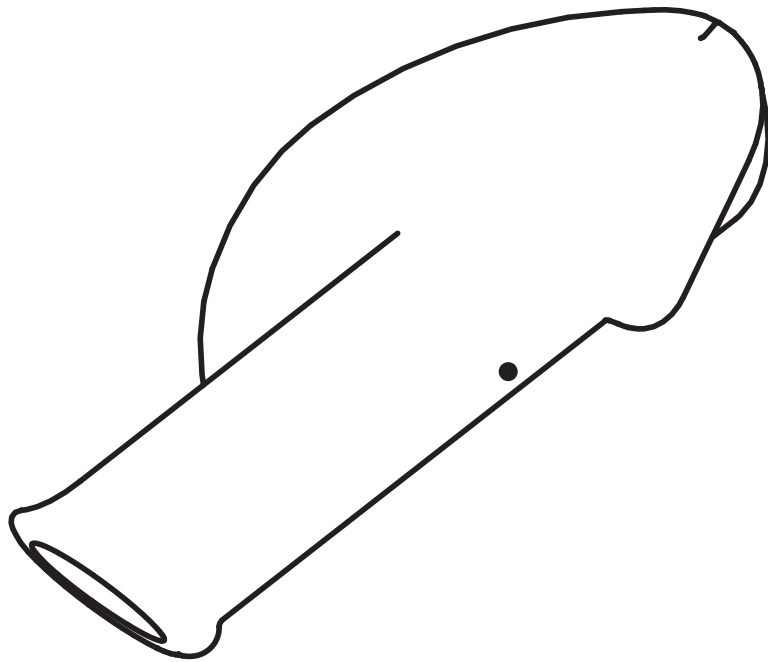

Benämning

Artikelnummer

Anatomiskt grepp till körhandtag, alla Gemino modeller, höger



9012011

Anatomiskt grepp till körhandtag, alla Gemino modeller, vänster



9012012

GEMINO

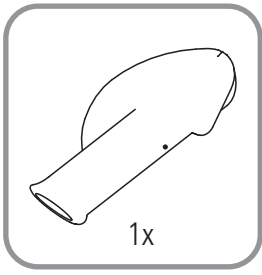
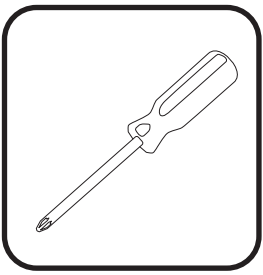

1

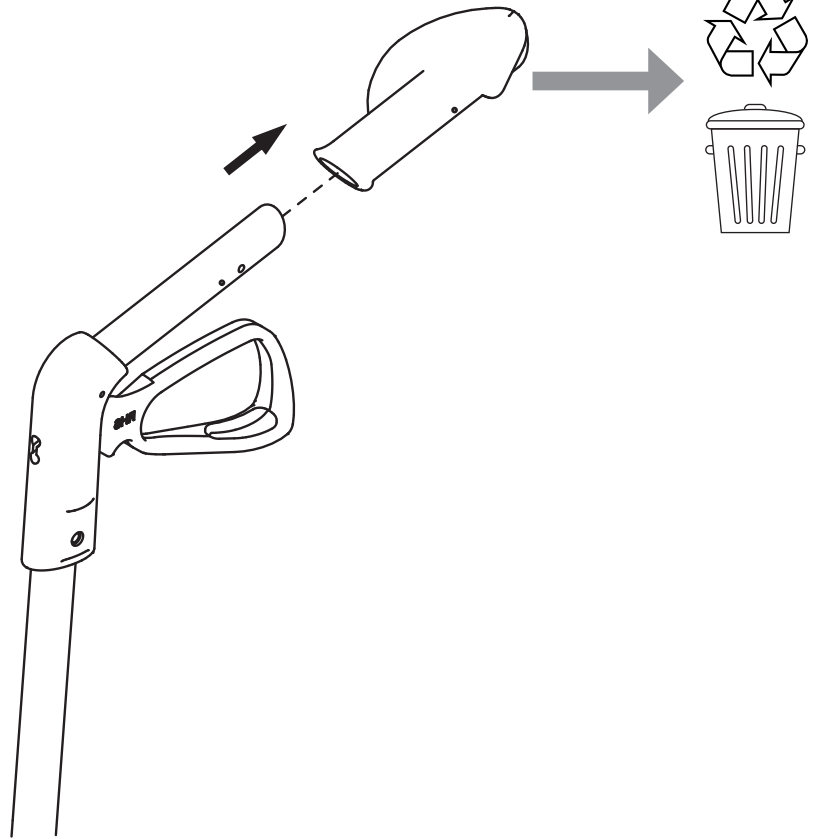
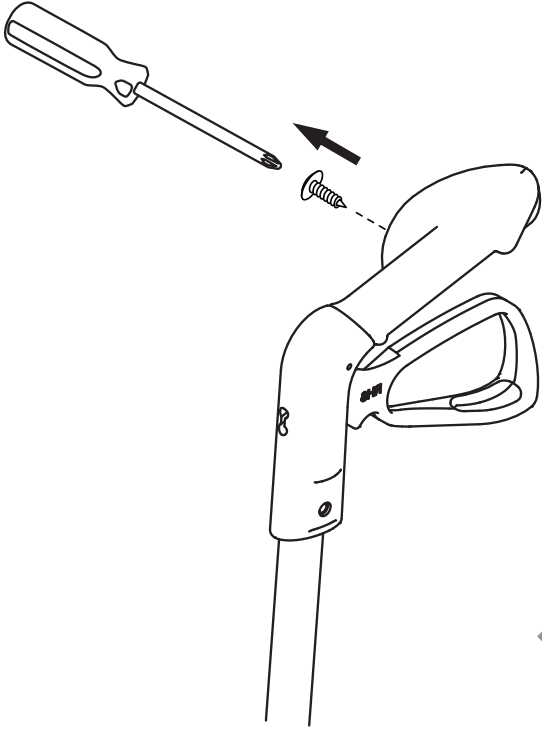

2

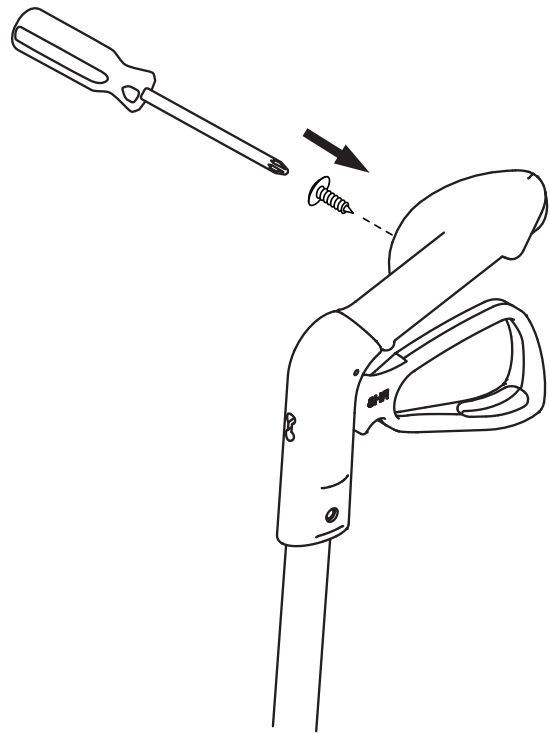
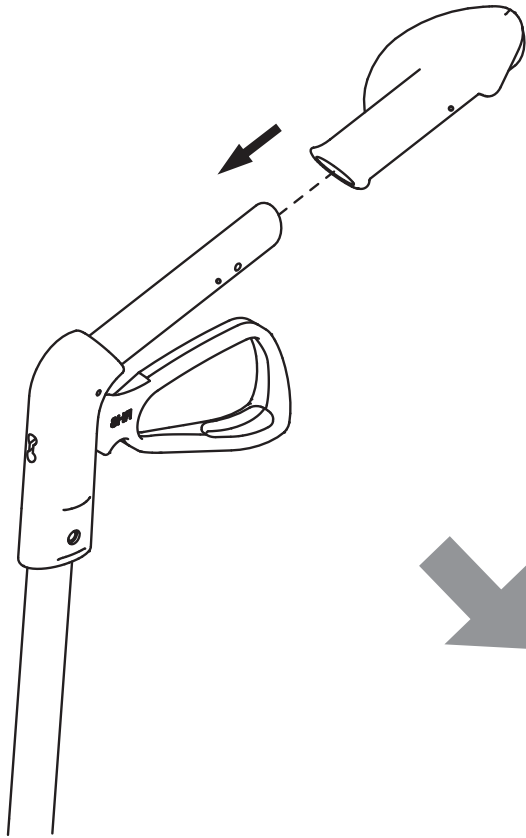

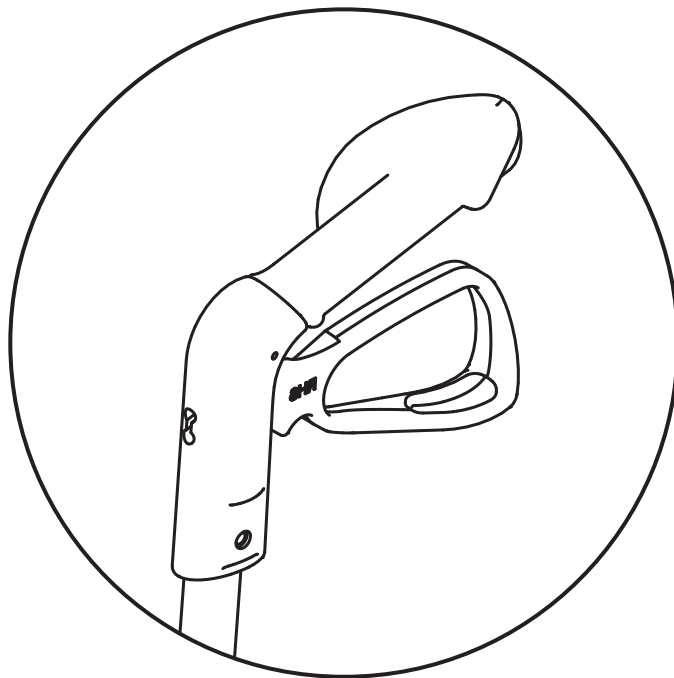

Sunrise Medical HCM B.V.
Vossenbeemd 104
5705 CL Helmond
The Netherlands

T: +31 (0)492 59 38 88
E: customerservice@sunrisemedical.nl
www.SunriseMedical.eu



Sunrise Medical AB
Neogatan 5
431 53 Mölndal
Sverige

T: +46 (0) 31 748 37 00
E: post@sunrisemedical.se
www.sunrisemedical.se