



**Quickie IRIS**  
**May 2025**  
 EIZ4-2

**Mark For:**

**Submitting for:**  Quote  Order

Date: \_\_\_\_\_  
 Dealer Acct #: \_\_\_\_\_  
 Dealer: \_\_\_\_\_  
 Dealer Contact: \_\_\_\_\_  
 Dealer Address: \_\_\_\_\_  
 Dealer City: \_\_\_\_\_ ST: \_\_\_\_\_ ZIP: \_\_\_\_\_  
 Dealer Phone: ( ) \_\_\_\_\_ Fax: ( ) \_\_\_\_\_  
 Confirmation Email: \_\_\_\_\_  
 Confirm Via:  Fax  Email

PO#: \_\_\_\_\_  
**ADDITIONAL SHIPPING INFORMATION**  
 Ship To: \_\_\_\_\_  
 Attention: \_\_\_\_\_  
 Address: \_\_\_\_\_  
 Address: \_\_\_\_\_  
 Ship To City: \_\_\_\_\_ ST: \_\_\_\_\_ ZIP: \_\_\_\_\_  
 Ship To Phone: ( ) \_\_\_\_\_ Fax: ( ) \_\_\_\_\_

The **HCPCS CODES** herein are based on PDAC verification or interpretation of Medicare definitions and guidelines. Non-Medicare payers may accept alternative **HCPCS CODES**, including misc. codes to ensure access for their enrollees. The use of **HCPCS CODES** does not ensure coverage or payment.

✓	Option #	HCPCS	Definition	Price	✓	Option #	HCPCS	Definition	Price
---	----------	-------	------------	-------	---	----------	-------	------------	-------

**1. FRAME**

**Base Model**

<input type="checkbox"/>	183WM56	E1161	Quickie IRIS with True Fit Growth <i>For 14" sizes use E1233</i>	\$3,505.00
<input type="checkbox"/>	183WM107	E1161	Quickie IRIS True Fit - Transit included <i>For 14" sizes use E1233</i>	\$3,879.00

**Power Tilt**

Available with Heavy Duty. N/A with under mount Vent/Battery tray and Mono Back. Only available with Dual Post or Single Post Armrest styles with Desk and Full Length Classic Armrests. N/A with -5° pre tilt angle.

<input type="checkbox"/>	183PA53	K0108	Power Tilt (W/ Attendant & User Cntrl) Tilt Control mounts to armrest <input type="checkbox"/> Left <input type="checkbox"/> Right (Rear Facing)	\$2,964.00
--------------------------	---------	-------	--	------------

**Pre-Set Tilt Angle (55° range) (Default in Bold)**

<input type="checkbox"/>	183TA5	E1161	-5 to 50° <i>N/A w/ Heavy Duty and 12.5" STFH</i>	NC
<input type="checkbox"/>	183TA6	E1161	<b>0 to 55°</b>	NC
<input type="checkbox"/>	183TA7	E1161	+5 to 60° <i>N/A w/Heavy Duty Package</i>	NC

**Pre-Set Tilt Angle (40° range) (Default in Bold)**

<input type="checkbox"/>	183TA8	E1161	-5 to 35° <i>N/A w/ Heavy Duty and 12.5" STFH</i>	NC
<input type="checkbox"/>	183TA1	E1161	0 to 40°	NC
<input type="checkbox"/>	183TA10	E1161	<b>+5 to 45°</b> <i>N/A w/Heavy Duty Package</i>	NC

**Transit**

<input type="checkbox"/>	183TO45	K0108	WC-19 Transit Option	\$374.00
--------------------------	---------	-------	----------------------	----------

**Tilt Release Options**

<input type="checkbox"/>	183TT8		Foot Release - No Cables <i>N/A w/ Power Tilt, Vent and Battery Tray, 21-22" depth and +5° set-ups.</i> <input type="checkbox"/> Left <input type="checkbox"/> Right (Facing from rear)	NC
<input type="checkbox"/>	183TT12		Backrest Dual trigger cable releases <i>N/A w/ Power Tilt</i>	NC

**Frame Options**

<input type="checkbox"/>	183FS23		Standard Base and Seat Frame <i>Maximum Weight: 300 lbs.</i>	STD
<input type="checkbox"/>	183HV1		Heavy Duty Package (Max: <b>400lbs</b> ) <i>NA w/ Vent, Battery Tray and Mono Back</i>	\$460.00
<input type="checkbox"/>	183FS24	E1029	Vent/Battery Tray Base <i>NA w/ Power Tilt, Attendant Wheel Lock, Mono Back and 14" and 15" frame width; min 17" STFH.</i>	\$583.00
<input type="checkbox"/>	183FT46		Contracture Seat Frame <i>NA w/ 14" or 15" frame depths. NA w/ drop seat pan.</i>	NC

**Frame Struts**

<input type="checkbox"/>	183GY01		Fixed (Standard)	STD
<input type="checkbox"/>	183GY02		Width Adjusting System <i>Avail. range 14"-21". Max growth 22" N/A with Mono Back</i>	\$52.00

**2. SIZE / SEATING**

**Frame Width**

21" & 22" not available with removable stroller handle extension

<input type="checkbox"/>	183W5		14"	NC
<input type="checkbox"/>	183W6		15"	NC
<input type="checkbox"/>	183W7		16"	NC
<input type="checkbox"/>	183W8		17"	NC
<input type="checkbox"/>	183W9		18"	NC
<input type="checkbox"/>	183W10		19"	NC
<input type="checkbox"/>	183W11	E2201	20"	\$583.00
<input type="checkbox"/>	183W12	E2201	21"	\$583.00
<input type="checkbox"/>	183W13	E2201	22"	\$583.00

**Frame Width - Built 4 Me Options**

Requires Heavy Duty package

<input type="checkbox"/>	183W57	E2201	B4ME - 23" Width	\$816.00
<input type="checkbox"/>	183W58	E2202	B4ME - 24" Width	\$816.00

**Seat Type**

<input type="checkbox"/>	183ST35	E2231	Standard Seat Pan <i>For growth ranges, see Figure 1.5</i>	\$234.00
<input type="checkbox"/>	183ST36	E2231	Drop Seat Pan - <i>N/A w/ Power Tilt, HD, Contracture footrest system</i>	\$234.00
<input type="checkbox"/>	183ST54		Omit Seat Pan	NC

**JAY Cushions (Optional)**

To order any JAY cushions on-chair, please see the JAY price list. Cushion name or part number must be filled out with desired width and depth.

<input type="checkbox"/>	183JC20	JAY Bundled Cushion Cushion Name/Part #:	Price List
		Width: _____ Depth: _____	

**Made To Order Seating**

<input type="checkbox"/>	183QC02	JAY Surefit	See OF
<input type="checkbox"/>	183QC03	JAY Fit	See OF

**2. SIZE / SEATING (CONT) Fill out either A or B)**

**A. Setup By QUICKIE**

**A. User's Seated Height**

See **Figure 1.2**, Dimension B. Distance from seat surface to top of the head.

<input type="checkbox"/>	183SJ01	Less than 37"	NC
<input type="checkbox"/>	183SJ02	37" or Greater	NC

**A. User's Weight (Default in Bold)**

301-400 lb options only available w/ HD Package

<input type="checkbox"/>	183BO01	<b>0 - 300 lbs</b>	NC
<input type="checkbox"/>	183BO03	301 - 350 lbs	NC
<input type="checkbox"/>	183BO12	351 - 400 lbs	NC

**A. Desired Seat Depth**

See **Figure 1.1** for pricing, **Figure 1.2**, Dimension A for measurement

<input type="checkbox"/>	183SD7	14"	NC
<input type="checkbox"/>	183SD8	15"	NC
<input type="checkbox"/>	183SD9	16"	NC
<input type="checkbox"/>	183SD10	17"	Figure 1.1
<input type="checkbox"/>	183SD11	18"	Figure 1.1
<input type="checkbox"/>	183SD12	19"	Figure 1.1
<input type="checkbox"/>	183SD13	E2203 20"	Figure 1.1
<input type="checkbox"/>	183SD14	E2203 21"	Figure 1.1
<input type="checkbox"/>	183SD33	E2204 22"	Figure 1.1

**B. Setup By DEPTH**

**B. Frame Depth Range**

<input type="checkbox"/>	183FL91	Short Seat Frame 14"-18"	NC
<input type="checkbox"/>	183FL92	Medium Seat Frame 16"-20"	NC
<input type="checkbox"/>	183FL93	Long Seat Frame 18"-22"	NC

**B. Frame Depth**

<input type="checkbox"/>	183FD5	14" recommend short seat frame	NC
<input type="checkbox"/>	183FD6	15" recommend short seat frame	NC
<input type="checkbox"/>	183FD7	16" recommend short seat frame	NC
<input type="checkbox"/>	183FD8	17" recommend short seat frame	NC
<input type="checkbox"/>	183FD9	18" recommend medium seat frame	NC
<input type="checkbox"/>	183FD10	19" recommend medium seat frame	NC
<input type="checkbox"/>	183FD11	E2203 20" recommend long seat frame	\$641.00
<input type="checkbox"/>	183FD16	E2203 21" recommend long seat frame	\$641.00
<input type="checkbox"/>	183FD17	E2204 22" recommend long seat frame	\$1,051.00

OR

**A. Top of Cushion to Seat Rail**

See **FIGURE 1.3** Dimensions A & B. This measurement is taken from the top of the cushion to the upper surface of the seat rail. If the cushion has a wedged shape and/or has significant lateral pelvic contour, then determine the height of the cushion at the point where the ischial tuberosities would contact (not immerse) the cushion surface.

<input type="checkbox"/>	183CJ01	2 1/2" or Greater	NC
<input type="checkbox"/>	183CJ02	Less than 2 1/2"	NC
<input type="checkbox"/>	183CJ03	Below Seat Rail	NC

Figure 1.1

		3	2	1	Flush	-1	-2
Desired Seat Depth	14"	NC	NC	NC	NC	N/A	N/A
	15"	NC	NC	NC	NC	N/A	N/A
	16"	NC	NC	NC	NC	NC	N/A
	17"	\$641	NC	NC	NC	NC	NC
	18"	\$641	\$641	NC	NC	NC	NC
	19"	\$1,051	\$641	\$641	NC	NC	NC
	20"	N/A	\$1,051	\$641	\$641	NC	NC
	21"	N/A	N/A	\$1,051	\$641	\$641	NC
22"	N/A	N/A	N/A	\$1,051	\$641	\$641	

Figure 1.4

Frame Width	Seat Pan Growth
14"	14" - 16"
15"	15" - 16"
16"	16" - 18"
17"	17" - 18"
18"	18" - 20"
19"	19" - 20"
20"	20" - 22"
21"	21" - 22"
22"	NA

Figure 1.2

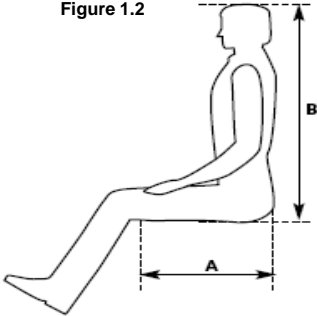
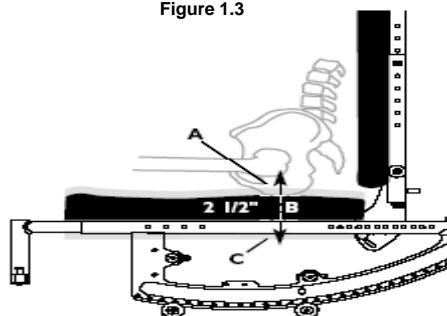

Figure 1.3



Front Seat Height
-------------------

Rear Wheel Size	CASTER SIZE					
	4"	5"	6"	8x1"	8x1.5"	8x2"
12" Mag	<input type="checkbox"/> 12.5"	<input type="checkbox"/> 13.5"	<input type="checkbox"/> 16.5"		<input type="checkbox"/> 16.5"	
		<input type="checkbox"/> 16.5"	<input type="checkbox"/> 17.0"	<input type="checkbox"/> 17.0"	<input type="checkbox"/> 17.0"	
		<input type="checkbox"/> 17.0"	<input type="checkbox"/> 17.5"	<input type="checkbox"/> 17.5"	<input type="checkbox"/> 17.5"	<input type="checkbox"/> 17.0"
		<input type="checkbox"/> 17.5"		<input type="checkbox"/> 18.0"	<input type="checkbox"/> 18.0"	<input type="checkbox"/> 18.0"
12" Low Poly		<input type="checkbox"/> 16.0"	<input type="checkbox"/> 16.0"		<input type="checkbox"/> 16.0"	
		<input type="checkbox"/> 16.5"	<input type="checkbox"/> 16.5"	<input type="checkbox"/> 16.5"	<input type="checkbox"/> 16.5"	<input type="checkbox"/> 16.5"
		<input type="checkbox"/> 17.0"	<input type="checkbox"/> 17.0"	<input type="checkbox"/> 17.0"	<input type="checkbox"/> 17.0"	<input type="checkbox"/> 17.0"
		<input type="checkbox"/> 17.5"		<input type="checkbox"/> 17.5"		
16" Mag		<input type="checkbox"/> 13.5"				
		<input type="checkbox"/> 14.0"				
		<input type="checkbox"/> 14.5"	<input type="checkbox"/> 14.5"			
		<input type="checkbox"/> 15.0"	<input type="checkbox"/> 15.0"			
		<input type="checkbox"/> 18.0"	<input type="checkbox"/> 18.0"	<input type="checkbox"/> 18.0"	<input type="checkbox"/> 18.0"	<input type="checkbox"/> 18.0"
		<input type="checkbox"/> 18.5"	<input type="checkbox"/> 18.5"	<input type="checkbox"/> 18.5"	<input type="checkbox"/> 18.5"	
20" Mag / 5 Spoke		<input type="checkbox"/> 16.0"	<input type="checkbox"/> 16.0"		<input type="checkbox"/> 16.0"	
		<input type="checkbox"/> 16.5"	<input type="checkbox"/> 16.5"	<input type="checkbox"/> 16.5"	<input type="checkbox"/> 16.5"	<input type="checkbox"/> 16.5"
		<input type="checkbox"/> 17.0"	<input type="checkbox"/> 17.0"	<input type="checkbox"/> 17.0"	<input type="checkbox"/> 17.0"	<input type="checkbox"/> 17.0"
		<input type="checkbox"/> 17.5"		<input type="checkbox"/> 17.5"		
22" Mag / 5 Spoke		<input type="checkbox"/> 17.0"	<input type="checkbox"/> 17.0"	<input type="checkbox"/> 17.0"		<input type="checkbox"/> 17.0"
		<input type="checkbox"/> 17.5"	<input type="checkbox"/> 17.5"	<input type="checkbox"/> 17.5"	<input type="checkbox"/> 17.5"	
		<input type="checkbox"/> 18.0"	<input type="checkbox"/> 18.0"	<input type="checkbox"/> 18.0"	<input type="checkbox"/> 18.0"	<input type="checkbox"/> 18.0"
		<input type="checkbox"/> 18.5"		<input type="checkbox"/> 18.5"		
24" Mag / 5 Spoke & Spoke		<input type="checkbox"/> 18.0"	<input type="checkbox"/> 18.0"		<input type="checkbox"/> 18.0"	<input type="checkbox"/> 18.0"
		<input type="checkbox"/> 18.5"	<input type="checkbox"/> 18.5"	<input type="checkbox"/> 18.5"	<input type="checkbox"/> 18.5"	
		<input type="checkbox"/> 19.0"	<input type="checkbox"/> 19.0"	<input type="checkbox"/> 19.0"	<input type="checkbox"/> 19.0"	<input type="checkbox"/> 19.0"
			<input type="checkbox"/> 19.5"		<input type="checkbox"/> 19.5"	

Casters
---------

<input type="checkbox"/> 183CW73		4" x 1.25" Semi Pneumatic <i>N/A w/ Heavy Duty Option</i>	NC
<input type="checkbox"/> 183CW53		5" x 1" Polyurethane	NC
<input type="checkbox"/> 183CW7	E2219	5" x 1.5" Semi Pneumatic	\$100.00
<input type="checkbox"/> 183CW45		6" x 1" Polyurethane	NC
<input type="checkbox"/> 183CW35	E2219	6" x 1.5" Semi Pneumatic	\$100.00
<input type="checkbox"/> 183CW46		8" x 1" Polyurethane	NC
<input type="checkbox"/> 183CW39	E2219	8" x 1.5" Semi Pneumatic	\$100.00
<input type="checkbox"/> 183CW36	E2214 E2215	8" x 2" Pneumatic	\$169.00
<input type="checkbox"/> 183CW37	E2214 K0108	8" x 2" Pneumatic w/Insert	\$263.00

Axle Plate
------------

*One arm drive only available in 6 spoke Mags*

<input type="checkbox"/> 183AL33		Standard Axle Plate	NC
<input type="checkbox"/> 183AL17	E0958	One Arm Drive Axle Plate <i>N/A w/ 12" &amp; 16" mag, 24" spoke wheels.</i>	\$1,051.00
<input type="checkbox"/> 183OA2		One Arm Drive Standard Handrim	NC
<input type="checkbox"/> 183HM1		Right Hand Mount	NC
<input type="checkbox"/> 183HM2		Left Hand Mount	NC
<input type="checkbox"/> 183OA1		One Arm Drive Small Handrim <i>N/A w/ 20" mag wheels</i>	NC
<input type="checkbox"/> 183HM1		Right Hand Mount	NC
<input type="checkbox"/> 183HM2		Left Hand Mount	NC

4. WHEEL LOCKS / HUB LOCK							
---------------------------	--	--	--	--	--	--	--

Wheel Lock			
<input type="checkbox"/> 183WL8		Push to Lock	NC
<input type="checkbox"/> 183WL41		Attendant Wheel Lock (Foot Lock) <i>N/A w/ ext handles. N/A w/ one arm drive</i>	\$94.00
<input type="checkbox"/> 183WL10		Omit Wheel Lock	NC

Rear Wheel			
------------	--	--	--

*12"-16" N/A w/handrims. 12" w/attendant wheel lock N/A w/ +5 - 60° tilt angle.*

*20"-22" Mag wheel N/A w/Projection handrims. See matrix for availability*

<input type="checkbox"/> 183RW13		12" Mag Wheel	NC
<input type="checkbox"/> 183RW14		16" Mag Wheel	NC
<input type="checkbox"/> 183RW3		20" Mag Wheel	NC
<input type="checkbox"/> 183RW8		22" Mag Wheel	NC
<input type="checkbox"/> 183RW1		24" Mag Wheel	NC
<input type="checkbox"/> 183RW51		24" Spoke Wheel	\$234.00
<input type="checkbox"/> 183RW103		20" Mag Wheel 5 Spoke	NC
<input type="checkbox"/> 183RW104		22" Mag Wheel 5 Spoke	NC
<input type="checkbox"/> 183RW102		24" Mag Wheel 5 Spoke	NC

Rear Tire & Wheel Matrix
--------------------------

Tire	Rear Wheel		
	5 Spoke Mag	Spoke	Mag Wheel
Pneumatic	20,22,24	24	12,16,20,22,24
Pneumatic w/ Airless Insert	20,22,24	24	12,16,20,22,24
Full Poly	20,22,24	24	20,22,24
Low Poly	NA	NA	12

12" = 203mm 16" = 305mm 20" = 451mm 22" = 501mm 24" = 540mm

Rear Wheel Tire			
-----------------	--	--	--

<input type="checkbox"/> 183RT3		Full Polyurethane	NC
<input type="checkbox"/> 183RT4		Low Polyurethane	NC
<input type="checkbox"/> 183RT1		Pneumatic	NC
<input type="checkbox"/> 183RT2	E2213 E2211	Pneumatic Airless Insert	\$100.00

Handrim			
---------	--	--	--

*12" and 16" wheels not available with hand rims. See matrix for availability*

<input type="checkbox"/> 183HR1		Aluminum Anodized	NC
<input type="checkbox"/> 183HR4		Plastic Coated	\$129.00
<input type="checkbox"/> 183HR7		Omit Handrim	NC

Rear Wheel & Handrim Matrix
-----------------------------

Handrim	Rear Wheel		
	5 Spoke Mag	Spoke	Mag Wheel
Aluminum Anodized	20,22,24	24	20,22,24
Plastic Coat	20,22,24	24	20,22,24
Projection 8 Oblique	NA	NA	24

Projections			
-------------	--	--	--

*Not available on plastic coated. Only available with 24" rim MAG wheels*

<input type="checkbox"/> 183HR8		8 Oblique	\$379.00
---------------------------------	--	-----------	----------

Axle			
------	--	--	--

<input type="checkbox"/> 183AX1		Quick Release Axles <i>N/A w/ one arm drive</i>	NC
<input type="checkbox"/> 183AX17		Threaded Axles <i>N/A w/ 24" spoke wheels</i>	NC

Option #	HCPCS	Definition	Price	Option #	HCPCS	Definition	Price
----------	-------	------------	-------	----------	-------	------------	-------

**5. HANGER AND FOOTREST**

**Footrest (Choose ONE Option - A, B, or C)**

**A. Hanger Mounted Footrest**

<input type="checkbox"/>	183H140	70° Swing In/Swing Out -Front Mount	NC
<input type="checkbox"/>	183H142	80° Swing In/Swing Out -Front Mount	NC
<input type="checkbox"/>	183H158	90° Swing In/Swing Out -Front Mount	NC
<input type="checkbox"/>	183H146	70° Heavy Duty Front Mount Lift Off	\$110,00
<input type="checkbox"/>	183H132	80° Heavy Duty Front Mount Lift Off N/A w/ 4" casters	\$110,00
<input type="checkbox"/>	183H147	90° Heavy Duty Front Mount Lift Off N/A w/ 4" casters	\$110,00
<input type="checkbox"/>	183H161	Elevating Hanger - Front Mount N/A 90° footboard, some interference with casters if not tilted, 17" wide chairs & up.	\$367,00

**A**

**A. Hanger Mounted Footrest Extension Tubes**

N/A w/ 12.5" seat height

<input type="checkbox"/>	183E23	2" N/A w/ 90 swing away, 90 lift off hangers	\$63,00
<input type="checkbox"/>	183E24	4" N/A w/ 90 swing away, 90 lift off hangers	\$63,00

**A. Hanger Mounted Footrest Footplates**

Heel loop or leg strap not included, See Footplate Options Section

<input type="checkbox"/>	183F4	K0040 Kids Angle Adj Available w/ 14" to 16" frame width only	\$221,00
<input type="checkbox"/>	183F8	K0040 Adult Angle Adj - Front Mount	\$221,00
<input type="checkbox"/>	183A7	Omit Footplate	NC

**B. Extension Tube Mounted Footrests**

Footrests mount to extension tubes

<input type="checkbox"/>	183H145	60° Swing In/Swing Out	NC
<input type="checkbox"/>	183H139	70° Swing In/Swing Out	NC
<input type="checkbox"/>	183H141	80° Swing In/Swing Out N/A w/ 8" casters	NC
<input type="checkbox"/>	183H160	Elevating Hanger - Ext Mount N/A w/ Platform Flip Up and Alum Angle Adj Front Mount footplates.	\$367,00
<input type="checkbox"/>	183H159	K0053 Articulating Hanger N/A w/ Platform Flip Up and Alum Angle Adj Front Mount footplates.	\$431,00

**B**

**B. Extension Tube Mounted Footrests**

<input type="checkbox"/>	183E1	Short	NC
<input type="checkbox"/>	183E2	Medium N/A with 12.5" seat height	NC
<input type="checkbox"/>	183E5	Long N/A with 12.5" seat height	NC
<input type="checkbox"/>	183E16	High Mount Only available with adult or kids angle adj. footplates	\$88,00

**B. Extension Tube Mounted Footrest Footplates**

Heel loop or leg strap not included, See Footplate Options Section

<input type="checkbox"/>	183F1	Composite	STD
<input type="checkbox"/>	183F271	K0040 Composite Angle Adj-(16"-22"w)	\$211,00
<input type="checkbox"/>	183F5	Aluminum Only available w/ELR	NC
<input type="checkbox"/>	183F3	K0040 Adult Angle Adjustable - Ext Mount	\$221,00
<input type="checkbox"/>	183F48	K0040 Platform Flip-Up N/A w/ med ext tubes.	\$221,00
<input type="checkbox"/>	183F7	Omit Footplate and Ext. Tube	-\$15,00

**Articulating / Elevating Hanger Cover**

<input type="checkbox"/>	183DI47	Neoprene Cover	\$397,00
<input type="checkbox"/>	183DI48	Gel Pad Cover	\$467,00

**OR**

**C. Contracture Footrest System**

Multi-Adjustable Padded Hangers & Angle Adjustable Aluminum Footrests

<input type="checkbox"/>	183H26	K0108 Contracture Footrest System N/A w/ drop seat pan. N/A w/ 15" frame depth	\$408,00
<input type="checkbox"/>	183FP02	Outside Mount	NC
<input type="checkbox"/>	183FP01	Center Mount	NC

Select Extension Height Below for Short

<input type="checkbox"/>	183E25	Short	
<input type="checkbox"/>	183EP1	10.5" Extension Height	NC
<input type="checkbox"/>	183EP2	11.0" Extension Height	NC
<input type="checkbox"/>	183EP3	11.5" Extension Height	NC
<input type="checkbox"/>	183EP4	12.0" Extension Height	NC
<input type="checkbox"/>	183EP5	12.5" Extension Height	NC
<input type="checkbox"/>	183EP6	13.0" Extension Height	NC

Select Extension Height Below for Regular

<input type="checkbox"/>	183E26	Regular	
<input type="checkbox"/>	183EP5	12.5" Extension Height	NC
<input type="checkbox"/>	183EP6	13.0" Extension Height	NC
<input type="checkbox"/>	183EP7	13.5" Extension Height	NC
<input type="checkbox"/>	183EP8	14.0" Extension Height	NC
<input type="checkbox"/>	183EP9	14.5" Extension Height	NC
<input type="checkbox"/>	183EP10	15.0" Extension Height	NC

**C**

**OR**

**Z-finity Hangers/Footrest System**

*(Maximum weight capacity for Z-Finity footrests is 165 lbs)*

*Some interference may exist in certain configurations.*

<input type="checkbox"/>	183H162	Z-finity Hanger	\$408,00
--------------------------	---------	-----------------	----------

**Z-finity Footrest Mount**

<input type="checkbox"/>	183DI22	Direct Hanger Mt/Fixed Frame - High	NC
<input type="checkbox"/>	183DI23	Direct Hanger Mt/Fixed Frame - Low	NC
<input type="checkbox"/>	183DI24	Extension Tube Mount	NC

**Z-finity Footrest Pivot Arm**

<input type="checkbox"/>	183DI20	Short 2"	NC
<input type="checkbox"/>	183DI21	Long 3 1/4"	NC

**Z-finity Footplate**

*Some interference may exist in certain configurations.*

<input type="checkbox"/>	183F320	K0040 Multi Angle Adjustable (Pair) (not avail. w/8"-9" widths)	\$216,00
<input type="checkbox"/>	183F321	K0040 Angle Adjustable Platform Footboard	\$250,00
<input type="checkbox"/>	183F6	Omit Footplate	NC

**Z-finity Extension Tube Length (When Choosing Ext. Tube Mount)**

<input type="checkbox"/>	183E62	Hemi Short	NC
<input type="checkbox"/>	183E1	Short	NC
<input type="checkbox"/>	183E2	Medium	NC
<input type="checkbox"/>	183E5	Long	NC

**D**

**Additional Hanger and Footplate Options**

**Hanger Mounts**

1" Offset N/A with -5-50° and -5-35° preset tilt angle and possible interference with 80° & 90° hangers

<input type="checkbox"/>	183MZ02	Standard Hanger Mount	STD
<input type="checkbox"/>	183MZ01	1" Offset Hanger Mount	\$36,00

**Footrest Options**

<input type="checkbox"/>	183HL1	E0951 Heel Loop	\$47,00
<input type="checkbox"/>	183HL5	K0038 Leg Strap	\$47,00
<input type="checkbox"/>	183IG2	Impact Guard Neoprene Only available w/ 60° or 70° ext. mount hanger	\$105,00
<input type="checkbox"/>	183H32	Omit Hanger	-\$15,00
<input type="checkbox"/>	183HL4	Omit Heel Loop	NC
<input type="checkbox"/>	183HL6	Omit Single Leg Strap	NC

**5. HANGER AND FOOTREST (CONT)**

**JAY FOOT BOXES**

*Only available with Swing Away, Lift-off Hangers, Adult Angle Adj Footplates and ELR / ALR. Single Foot Box pairs N/A with 14"-15" frame widths. Full Foot Boxes N/A with Heel Loop or Leg Strap, Tall Height Full Footbox w/ 14"-15" frame width and ELR / ALR. Full Foot Box not available with 23"-24" widths.*

**Single Foot Box**

<input type="checkbox"/>	183JX01	E0954	Standard Height - Left	\$263.00
<input type="checkbox"/>	183JX02	E0954	Tall Height - Left	\$263.00
<input type="checkbox"/>	183JX03	E0954	Standard Height - Right	\$263.00
<input type="checkbox"/>	183JX04	E0954	Tall Height - Right	\$263.00

**JAY FOOT BOXES (cont)**

<input type="checkbox"/>	183JX05	E0954	Standard Height - Pair	\$526.00
<input type="checkbox"/>	183JX06	E0954	Tall Height - Pair	\$526.00
<b>OR</b>				
<input type="checkbox"/>	183JX07	E0954	Full Foot box Std Height	\$468.00
<input type="checkbox"/>	183JX08	E0954	Full Foot box Tall Height	\$468.00
<input type="checkbox"/>	183JX09	E0954	Full Foot box w/ Divider Std Ht	\$525.00
<input type="checkbox"/>	183JX10	E0954	Full Foot box w/ Divider Tall Ht	\$525.00

**6. BACKREST / SEATING**

**Dynamic Backrest**

<input type="checkbox"/>	183BT101	E2398	Dynamic Backrest N/A w/ Reclining Backrest or 21"-22" seat depth. N/A w/ Heavy D.	\$1,744.00
--------------------------	----------	-------	--	------------

**Built 4 Me Options**

<input type="checkbox"/>	183VU18		B4ME - Dynamic Back w/19" Depth	\$641.00
<input type="checkbox"/>	183VU19		B4ME - Dynamic Back w/20" Depth	\$641.00

**JAY J3 Back**

<input type="checkbox"/>	183JB01		JAY J3 Back N/A w/ O2 Holder	See OF
--------------------------	---------	--	---------------------------------	--------

**Backpost Style - (Choose ONE Option - A, B, C, or D)**

**A. Stroller Handle Backpost (Fixed)**

<input type="checkbox"/>	183BP9		Low (18")	NC
<input type="checkbox"/>	183BP10		Medium (21")	NC
<input type="checkbox"/>	183BP11		Tall (24")	NC
<input type="checkbox"/>	183BP13		Removable Extension N/A w/ 21"-22" frame width, height adj back with adj stroller handles	\$100.00

**OR**

**B. Height Adjustable Back w/ Adj. Stroller Handles**

**Select desired Push Handle**

<input type="checkbox"/>	183PH8		Standard Push Handle	NC
<input type="checkbox"/>	183PH9		Long Push Handle Recommended in combo w/ vent & battery tray	NC

**AND select desired Back Cane**

<input type="checkbox"/>	183B200		Standard 15"-21"	NC
<input type="checkbox"/>	183B201		Tall 18"-24"	NC

**OR**

**C. Reclining Backrest (0-40°)**

*Only available with 40 degree tilt range. N/A w/ 22" Deep Frame.*

<input type="checkbox"/>	183BT21	E1225	Reclining Backrest	\$1,032.00
<input type="checkbox"/>	183B5		Medium	NC
<input type="checkbox"/>	183B9		Tall	NC
<input type="checkbox"/>	183BP64		Angle Adj stroller handles Height adj range 19"-23"	\$175.00
<input type="checkbox"/>	183PH8		Standard push handle	NC
<input type="checkbox"/>	183PH9		Long push handle	NC

**OR**

**D. Mono Back System**

*Must select JAY J3 or JAY personalized Back when ordering Mono Back System.*

**Select One**

<input type="checkbox"/>	183MO1		Mono Backrest System	\$578.00
<input type="checkbox"/>	183MO2	E2398	Mono Backrest System w/Dynamic Backrest	\$1,744.00

**AND Select desired Push Handle**

<input type="checkbox"/>	183PH8		Standard Push Handle	NC
<input type="checkbox"/>	183PH9		Long Push Handle	NC

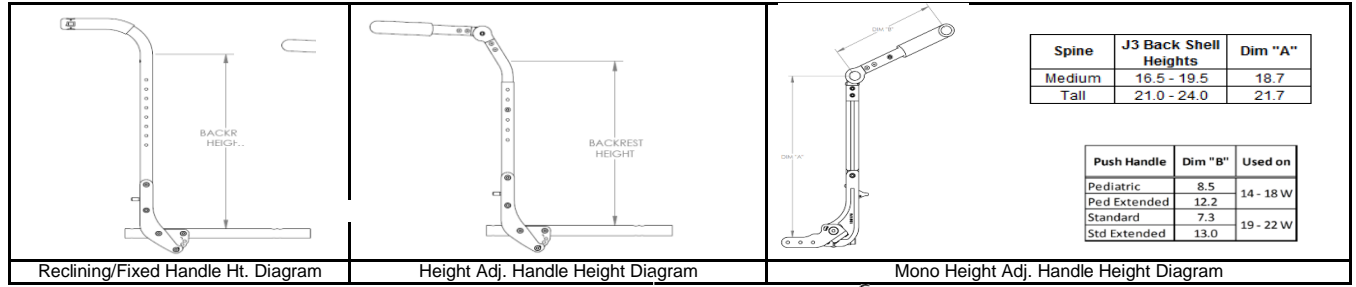

**Backrest Position (set up by Quickie)**

See **FIGURE 1.5**. The location of the backrest surface in relation to the front of the backpost. The measurement is taken from the front surface of the backpost to the deepest area of the backrest in contact with the user's body.

<input type="checkbox"/>	183BQ01	+3"	NC
<input type="checkbox"/>	183BQ05	+2"	NC
<input type="checkbox"/>	183BQ02	+1"	NC
<input type="checkbox"/>	183BQ03	Flush	NC
<input type="checkbox"/>	183BQ04	-1"	NC
<input type="checkbox"/>	183BQ06	-2"	NC

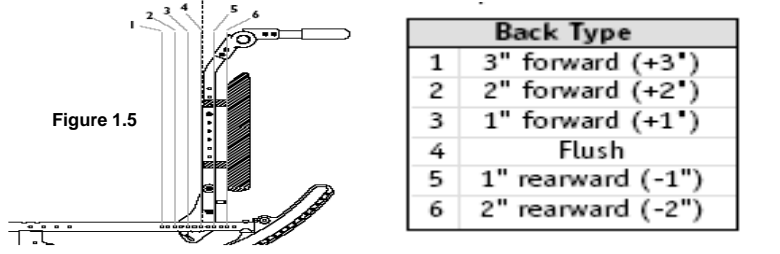

✓	Option #	HCPCS	Definition	Price	✓	Option #	HCPCS	Definition	Price
---	----------	-------	------------	-------	---	----------	-------	------------	-------

**6. BACKREST / SEATING (CONT)**

**Mono Backrest Options ONLY**

*N/A on HD, Vent/Battery Tray Base(LTV only), Reclining Backrest, Desk Length Armpads and Canopy.*

**JAY J3 Back for Mono Backrest System**

<input type="checkbox"/>	183JB04		JAY J3 Back Mono	See OF
<input type="checkbox"/>	183JB05		JAY J3 via JAY Your Way	See OF

**JAY J3 Backrest Contour**

<input type="checkbox"/>	183JP01	E2613	J3 PA Back (2.2" of Contour Depth) 14"-20" Wide	\$625,00
<input type="checkbox"/>	183JP02	E2614	J3 PA Back (2.2" of Contour Depth) 22" Wide	\$927,00
<input type="checkbox"/>	183JP03	E2615	J3 PL Back (3.0" of Contour Depth) 14"-20" Wide	\$729,00
<input type="checkbox"/>	183JP04	E2620	J3 PDL Back (6.0" of Contour Depth) 14"-20" Wide	\$875,00
<input type="checkbox"/>	183JP05	E2620	J3 PDC Back (6.0" of Contour Depth) 14"-20" Wide	\$875,00

**JAY J3 Backrest Height**

<input type="checkbox"/>	183JR07		UT Standard 16.5" shell height	NC
<input type="checkbox"/>	183JR08		UT Medium 18" shell height	NC
<input type="checkbox"/>	183JR09		UT Tall 19.5" shell height	NC
<input type="checkbox"/>	183JR10		SH Standard 21" Shell Height	NC
<input type="checkbox"/>	183JR11		SH Medium 22.5"	NC
<input type="checkbox"/>	183JR12		SH Tall 24"	NC

**JAY J3 Backrest Width**

*Some interference with armrest may exist when ordering a Backrest with greater than 4" wider than the base.*

<input type="checkbox"/>	183JQ06		12" Backrest Width	NC
<input type="checkbox"/>	183JQ01		14" Backrest Width	NC
<input type="checkbox"/>	183JQ02		16" Backrest Width	NC
<input type="checkbox"/>	183JQ03		18" Backrest Width	NC
<input type="checkbox"/>	183JQ04		20" Backrest Width	NC

**JAY J3 Backrest Color**

<input type="checkbox"/>	183GZ01		Black	NC
<input type="checkbox"/>	183GZ02		Matching Frame- Standard Colors	NC
<input type="checkbox"/>	183GZ03		Matching Frame- Personalized Color	\$58,00

**JAY J3 Back for Mono Backrest System Cont.**

**Select desired Headrest Mount (optional)**

<input type="checkbox"/>	183MH10	E1033	Axys Mount & Bracket	\$259,00
<input type="checkbox"/>	183MH15	E1033	Cobra Flip Back Mount and Bracket	\$393,00
<input type="checkbox"/>	183MH16	E1033	Onyx Mount and Bracket	\$234,00
<input type="checkbox"/>	183MH17		Omit	NC

**Select desired Headrest Pad (optional)**

<input type="checkbox"/>	183HE65	E0955	Plush Head Support Pad 8"	\$190,00
<input type="checkbox"/>	183HE66	E0955	Plush Head Support Pad 10"	\$190,00
<input type="checkbox"/>	183HE78	E0955	Plush Head Support Pad 14"	\$205,00
<input type="checkbox"/>	183HE87	E0955	HeadsUp Lrg: 5.3" Lng Arms	\$365,00
<input type="checkbox"/>	183HE88	E0955	HeadsUp Med: 4.1" Sht Arms	\$365,00
<input type="checkbox"/>	183HE89	E0955	HeadsUp Sml: 3.5" Sht Arms	\$365,00
<input type="checkbox"/>	183HE83	E0955	Adjust-A-Plush Standard	\$307,00
<input type="checkbox"/>	183HE82	E0955	Adjust-A-Plush Narrow	\$307,00

**Select desired Lateral (optional)**

<input type="checkbox"/>	<b>LAT 4X4 S/A MOUNTS includes 1" OFFSET - PR</b>			\$910,00
	183ZV14	E0956	LATERAL 4X4 W/ 1" OFFSET - PAIR	\$294,00
	183ZS07	E1034	LATERAL SWING AWAY MOUNT - PAIR	\$616,00
<input type="checkbox"/>	<b>LAT 4X5 S/A MOUNTS includes 1" OFFSET - PR</b>			\$910,00
	183ZV15	E0956	LATERAL 4X5 W/ 1" OFFSET - PAIR	\$294,00
	183ZS07	E1034	LATERAL SWING AWAY MOUNT - PAIR	\$616,00
<input type="checkbox"/>	<b>LAT 4X6 S/A MOUNTS includes 1" OFFSET - PR</b>			\$910,00
	183ZV16	E0956	LATERAL 4X6 W/ 1" OFFSET - PAIR	\$294,00
	183ZS07	E1034	LATERAL SWING AWAY MOUNT - PAIR	\$616,00
<input type="checkbox"/>	<b>LAT 6X4 S/A MOUNTS includes 1" OFFSET - PR</b>			\$910,00
	183ZV17	E0956	LATERAL 6X4 W/ 1" OFFSET - PAIR	\$294,00
	183ZS07	E1034	LATERAL SWING AWAY MOUNT - PAIR	\$616,00
<input type="checkbox"/>	<b>LAT 6X5 S/A MOUNTS includes 1" OFFSET - PR</b>			\$910,00
	183ZV18	E0956	LATERAL 6X5 W/ 1" OFFSET - PAIR	\$294,00
	183ZS07	E1034	LATERAL SWING AWAY MOUNT - PAIR	\$616,00
<input type="checkbox"/>	<b>LAT 6X6 S/A MOUNTS includes 1" OFFSET - PR</b>			\$910,00
	183ZV19	E0956	LATERAL 6X6 W/ 1" OFFSET - PAIR	\$294,00
	183ZS07	E1034	LATERAL SWING AWAY MOUNT - PAIR	\$616,00

**7. ARMREST / SIDE GUARDS**

**Armrest**

*Heavy Duty Option only available w/ Dual Post Armrest. Power tilt option is only available with Dual Post or Single Post Armrest styles.*

<input type="checkbox"/>	183AA63	E0973	Dual Post Height Adjustable	\$314,00
<input type="checkbox"/>	183AA43		Dual Post Flip Back	\$227,00
<input type="checkbox"/>	183AA62		Dual Post	NC
<input type="checkbox"/>	183AA48	E0973	Dual Post Flip Back Height Adj	\$345,00
<input type="checkbox"/>	183AA11	E0973	Single Post Height Adjustable - Std	\$333,00
<input type="checkbox"/>	183AA29	E0973	Single Post Height Adjustable - Low	\$333,00
<input type="checkbox"/>	183AA7	E0973	Length Adjustable Locking Flip-Up <i>N/A w/ Contour Armpad</i>	\$321,00
<input type="checkbox"/>	183AA1	E0973	Adjustable Locking Flip-Up	\$309,00
<input type="checkbox"/>	183AA154	E0973	Height Adj. Cantilever Armrest <i>Available with Mono Back only. N/A w/ 20", 22" and 24" rear wheels.</i>	\$292,00
<input type="checkbox"/>	183AA14		Omit Armrest	NC

**Armrest Receiver (Single Post Height Adjustable Only)**

<input type="checkbox"/>	183AR17		Low	NC
<input type="checkbox"/>	183AR18		Std	NC

**Armpad**

*Ergo armpad only available with Single post Height adj armrest. Power tilt option is only available with Desk and Full Length Classic style.*

<input type="checkbox"/>	183AM23		Desk Length Classic	NC
<input type="checkbox"/>	183AM21		Desk Length Contour	NC
<input type="checkbox"/>	183AM24		Full Length Classic	NC
<input type="checkbox"/>	183AM22		Full Length Contour	NC
<input type="checkbox"/>	183AM9		Foam Short <i>Option for Length Adj Locking Flip Up</i>	NC
<input type="checkbox"/>	183AM10		Foam Long <i>Option for Length Adj Locking Flip Up</i>	NC
<input type="checkbox"/>	183AM27		Ergo armpad	NC

**Side Guard**

*Only available w/ length adj locking flip-up and adj locking flip-up armrest styles. N/A w/ Mono Back.*

<input type="checkbox"/>	183SG3	K0108	Plastic Regular	\$169,00
<input type="checkbox"/>	183SG4	K0108	Plastic Kids	\$169,00

Option #	HCPCS	Definition	Price	Option #	HCPCS	Definition	Price
<b>7. ARMREST / SIDE GUARDS (CONT)</b>							

**JAY Arm Troughs**

NA with Length Adj. Locking Flip Up and Adj Locking Flip Up armrests.  
Full Length Classic Armpads will automatically be selected when choosing only one side Arm Trough.

<input type="checkbox"/>	183JL01	E2209	Arm Trough - 14" long - Left	\$239,00
<input type="checkbox"/>	183JL04	E2209	Arm Trough - 14" long - Right	\$239,00
<input type="checkbox"/>	183JL05	E2209	Arm Trough - 14" long - Pair	\$478,00
<input type="checkbox"/>	183JL02	E2209	Arm Trough - 18" long - Left	\$239,00
<input type="checkbox"/>	183JL06	E2209	Arm Trough - 18" long - Right	\$239,00
<input type="checkbox"/>	183JL07	E2209	Arm Trough - 18" long - Pair	\$478,00
<input type="checkbox"/>	183JL03	E2209	Arm Trough - 22" long - Left	\$239,00
<input type="checkbox"/>	183JL08	E2209	Arm Trough - 22" long - Right	\$239,00
<input type="checkbox"/>	183JL09	E2209	Arm Trough - 22" long - Pair	\$478,00

**JAY Arm Trough - Hardware**

<input type="checkbox"/>	183JN01		Fixed (EA)	NC
<input type="checkbox"/>	183JN03		Fixed (Pair)	NC
<input type="checkbox"/>	183JN02	E1034	Swing Away - Rotational (EA)	\$292,00
<input type="checkbox"/>	183JN04	E1034	Swing Away - Rotational (Pair)	\$583,00

Armrest Matrix for Single Post					
Armrest Size	Transfer Tube Length D	Receiver	Classic Pad		
			H Range	Pad length L	
Std	8"	Std	10-3/4" to 15-3/4"	10-1/4"	14"
		Low	8-3/4" to 13-3/4"		
		Std	9" to 13"		
Low	5-1/4"	Low	7-1/4" to 11-1/4"		
		Contour Pad			
		Receiver	H Range	Pad length L	
		Std	10" to 15"	10-1/2"	14-1/4"
		Low	8-1/4" to 13-1/4"		
		Std	8-1/2" to 12-1/2"		
		Low	6-3/4" to 10-3/4"		
Ergo Pad					
		Receiver	H Range	Pad length L	
		Std	10-1/2" to 15-1/2"	11-3/4"	
		Low	8-3/4" to 13-3/4"		
		Std	9" to 13"		
Low	7-1/4" to 11-1/4"				

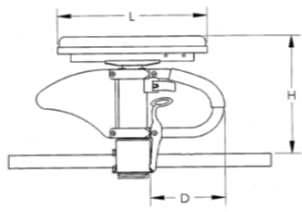

**8. KEY OPTIONS AND ACCESSORIES**

**Anti Tips**

Included with vent tray option. Not ordered as separate line item.

<input type="checkbox"/>	183AT1	E0971	Anti Tips (Pair)	\$175,00
--------------------------	--------	-------	------------------	----------

**Positioning Belt**

<input type="checkbox"/>	183ZZ25	E0978	JAY 2PT Belt 2" Push Btn No Pad	\$48,00
<input type="checkbox"/>	183ZZ26	E0978	JAY 2PT Belt 2" Push Btn 9.5" Pad	\$101,00
<input type="checkbox"/>	183ZZ27	E0978	JAY 2PT Belt 1.5" Push Btn No Pad	\$48,00
<input type="checkbox"/>	183ZZ28	E0978	JAY 2PT Belt 1.5" Push Btn 7.5" Pad	\$101,00
<input type="checkbox"/>	183A117	E0978	2" Aircraft Buckle w/Clamps	\$129,00
<input type="checkbox"/>	183A118	E0978	2" Aircraft Buckle Pad w/Clamp	\$139,00
<input type="checkbox"/>	183A120		Positioning Belt Clamps Only	\$58,00

**Spoke Guards**

N/A with 12" and 16" mag, 5 spoke Mag wheels or projection handrims.

<input type="checkbox"/>	183A24	K0065	Clear	\$134,00
<input type="checkbox"/>	183A23	K0065	Black	\$134,00

**Wheelchair Tray Table**

Only available if armrests are included. N/A with JAY Arm Troughs. Tray size availability will vary based on armrest style, see configurator for details.

<input type="checkbox"/>	183A30	E0950	Small (13"-14")	\$298,00
<input type="checkbox"/>	183A31	E0950	Medium (15"-17")	\$298,00
<input type="checkbox"/>	183A32	E0950	Large (18"-20")	\$311,00
<input type="checkbox"/>	183A33	E0950	X-Large (21"-22")	\$311,00

**Vent Tray - Back Cane Mount**

Utility hook has weight a limit of 15 lbs.

<input type="checkbox"/>	183LF12	E1029	Dovetail Vertical Frame Mounted Hardware for LTV Ventilators includes 1 utility hook	\$578,00
<input type="checkbox"/>	183LF13	E1029	Dovetail Vertical Frame Mounted Hardware for Trilogy Ventilators includes 1 utility hook	\$578,00

**JAY Positioning**

<input type="checkbox"/>	183K1	E1020	JAY Lower Extremity S/A support <input type="checkbox"/> Left <input type="checkbox"/> Right Position	\$460,00
<input type="checkbox"/>	183K2		Omit Hanger <input type="checkbox"/> Left <input type="checkbox"/> Right	-\$10,00
<input type="checkbox"/>	183K7		Pad Size <input type="checkbox"/> 6" x 8" <input type="checkbox"/> 8" x 10"	NC

**JAY Anterior Thoracic Support**

Style				
<input type="checkbox"/>	183JY01	E0960	Classic Dynamic	\$177,00
<input type="checkbox"/>	183JY02	E0960	Classic Structure	\$177,00
<input type="checkbox"/>	183JY03	E0960	Contour Dynamic	\$177,00
<input type="checkbox"/>	183JY04	E0960	Contour Structure	\$177,00
<input type="checkbox"/>	183JY05	E0960	Center Opening with Buckle	\$177,00

Size				
<input type="checkbox"/>	183JZ01		Small	NC
<input type="checkbox"/>	183JZ02		Medium	NC
<input type="checkbox"/>	183JZ03		Large	NC
<input type="checkbox"/>	183JZ04		X-Large	NC

**JAY Padded Trunk Strap**

<input type="checkbox"/>	183JA01	E0960	Padded Trunk Strap - Small	\$165,00
<input type="checkbox"/>	183JA02	E0960	Padded Trunk Strap - Medium	\$165,00
<input type="checkbox"/>	183JA03	E0960	Padded Trunk Strap - Large	\$165,00
<input type="checkbox"/>	183JA04	E0960	Padded Trunk Strap - XL	\$165,00

**Miscellaneous Accessories**

<input type="checkbox"/>	183A1		Black Utility Backpack	\$88,00
<input type="checkbox"/>	183A8		Black Seat Pouch	\$58,00
<input type="checkbox"/>	183A54	K0038	Extra Leg Strap Black	\$36,00
<input type="checkbox"/>	183A82		Caddy Only available w/ extention tube mounted footrests	\$58,00
<input type="checkbox"/>	183A601	E2208	O2 Holder N/A w/ Height Adj Stroller Handles. N/A w/ Reclining Backrest, Mono Back	\$187,00
<input type="checkbox"/>	183A701	K0105	IV Pole N/A w/ Mono Back	\$321,00
<input type="checkbox"/>	183A999		Quickie Water Bottle & Holder	\$63,00

**Canopy (SunShade)**

Need 2" back post clearance to mount canopy hardware. May require next height based on seating. Some interference may occur with some height configurations. N/A with Mono Back.

<input type="checkbox"/>	1838A06	K0108	Canopy (Sunshade) 10" - 14" wide	\$321,00
<input type="checkbox"/>	1838A07	K0108	Canopy (Sunshade) 15" - 20" wide	\$321,00

**Hanger Options**

Aluminum material. This option comes uninstalled.

Note: During swing In/Out process may wear out the paint on the frame over time.

<input type="checkbox"/>	183IE05	K0108	Enhanced hanger latch	\$79,00
--------------------------	---------	-------	-----------------------	---------

Option #	HCPCS	Definition	Price	Option #	HCPCS	Definition	Price
<b>9. COLOR</b>							
<b>Standard Frame Color</b>				<b>Personalized Frame Color</b>			
<input type="checkbox"/>	183C214	Black (Gloss)	NC	<input type="checkbox"/>	183C112	Desert Camouflage	\$460,00
<input type="checkbox"/>	183C215	Black (Matte)	NC	<input type="checkbox"/>	183C43	Mossy Oak Camouflage	\$460,00
<input type="checkbox"/>	183C211	Celestial Sapphire	NC	<input type="checkbox"/>	183C42	Stars & Stripes	\$460,00
<input type="checkbox"/>	183C212	Desert Sage	NC	<input type="checkbox"/>	183C108	Zebra (Choose above base color) Std with White unless above base paint is chosen N/A w/ Black & Matte Black)	\$460,00
<input type="checkbox"/>	183C213	Desert Tan	NC				
<input type="checkbox"/>	183C216	Metallic Shadow	NC				
<input type="checkbox"/>	183C217	Midnight Blue	NC				
<input type="checkbox"/>	183C218	Mystic Purple	NC				
<input type="checkbox"/>	183C219	Petal Pink	NC				
<input type="checkbox"/>	183C220	Pink Power	NC				
<input type="checkbox"/>	183C221	Red Pepper	NC				
<input type="checkbox"/>	183C222	Royal Blue	NC				
<input type="checkbox"/>	183C223	Salute Green	NC				
<input type="checkbox"/>	183C224	Scarlet Noir	NC				
<input type="checkbox"/>	183C225	Silver Ore	NC				
<input type="checkbox"/>	183C226	Solar Orange	NC				
<input type="checkbox"/>	183C227	Starlight White	NC				
<input type="checkbox"/>	183C228	Storm Gray	NC				
<input type="checkbox"/>	183C229	Turbo Green	NC				
<input type="checkbox"/>	183C230	Velocity Yellow	NC				

**Additional Options Through Built for Me**

To inquire about any unique personalized Quickie products, contact: Phone: (800) 333-4000, Fax: (800) 333 9011



- Commonly Requested Options Include:**
- ✓ **Frog Legs**
  - ✓ **Longer Wheel Lock Extensions**
  - ✓ **Reverse Configuration**
  - ✓ **Dual Mount Wheel Locks - Attendant Foot Lock**

**10. APPENDIX**  
**Lower Leg Length Matrix**

Front seat height must be at least 2" taller than lower leg length on all swing in/out hangers. Front seat height must be at least 2" taller than maximum lower leg length on all front mount hangers.

Hanger	Extension	Seat Pan to Top of Footrest		Min Allowable FSH
		Min	Max	
<b>70° Front Mount</b>	No Ext	3 1/2	9	11 1/2
	2"	3 1/2	11 1/2	13 1/2
	4"	3 1/2	13 1/2	15 1/2
<b>80° Front Mount</b>	No Ext	3 1/2	9 1/2	11 1/2
	2"	3 1/2	12	14
	4"	3 1/2	14	16
<b>90° Front Mount</b>	No Ext	3	9	11 1/2
<b>ELR Front Mount</b>	No Ext	3	7	10 1/2
<b>60° Swing In/Out</b>	Short	9	12 1/2	12 1/2
	Med	9	14 1/2	12 1/2
	Long	11 1/2	16	14 1/2
<b>70° Swing In/Out</b>	Short	10 1/2	15 1/2	12 1/2
	Med	10 1/2	17 1/2	13
	Long	13 1/2	19	15
<b>80° Swing In/Out</b>	Short	11	14 1/2	13
	Med	11	16 1/2	13
	Long	13	18	15
<b>ALR</b>	Short	8 1/2	15	10 1/2
	Med	10	17	12
	Long	12	19	14
<b>ELR Ext. Mount</b>	Short	8	14 1/2	10
	Medium	9 1/2	16 1/2	11 1/2
	Long	11 1/2	18 1/2	13 1/2

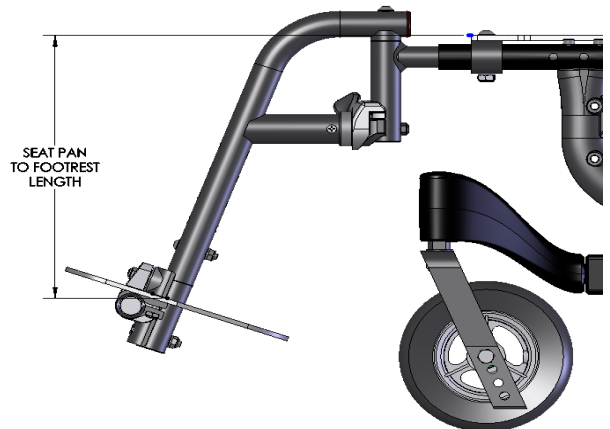



# JAY® Signature Series Backrest and Accessories

Note: Not all sizes and configurations shown below, for full offering visit [www.sunrisemedical.com](http://www.sunrisemedical.com)

When ordering mark the part number desired and it will be added to the order as a separate line item .

## JAY BACKREST

### JAY J3 Posterior (PA) BACK - 2.2" Contour Depth

	Shell Height	Shell Width															
Mid Thoracic (MT)	12.0" (S)	J3PAMTSxxFS	<input type="checkbox"/>	12	\$677	<input type="checkbox"/>	14	\$677	<input type="checkbox"/>	16	\$677	<input type="checkbox"/>	18	\$677	<input type="checkbox"/>	20	\$677
		J3PAMTSxxTH	<input type="checkbox"/>	12	\$677	<input type="checkbox"/>	14	\$677	<input type="checkbox"/>	16	\$677	<input type="checkbox"/>	18	\$677	<input type="checkbox"/>	20	\$677
Upper Thoracic (UT)	16.5" (S)	J3PAUTSxxFS	<input type="checkbox"/>	12	\$677	<input type="checkbox"/>	14	\$677	<input type="checkbox"/>	16	\$677	<input type="checkbox"/>	18	\$677	<input type="checkbox"/>	20	\$677
		J3PAUTSxxTH	<input type="checkbox"/>	12	\$677	<input type="checkbox"/>	14	\$677	<input type="checkbox"/>	16	\$677	<input type="checkbox"/>	18	\$677	<input type="checkbox"/>	20	\$677
	18.0" (M)	J3PAUTMxxFS	<input type="checkbox"/>	14	\$677	<input type="checkbox"/>	16	\$677	<input type="checkbox"/>	18	\$677	<input type="checkbox"/>	20	\$677	<input type="checkbox"/>	20	\$677
		J3PAUTMxxTH	<input type="checkbox"/>	14	\$677	<input type="checkbox"/>	16	\$677	<input type="checkbox"/>	18	\$677	<input type="checkbox"/>	20	\$677	<input type="checkbox"/>	20	\$677
	19.5" (T)	J3PAUTTxxFS	<input type="checkbox"/>	14	\$677	<input type="checkbox"/>	16	\$677	<input type="checkbox"/>	18	\$677	<input type="checkbox"/>	20	\$677	<input type="checkbox"/>	20	\$677
		J3PAUTTxxTH	<input type="checkbox"/>	14	\$677	<input type="checkbox"/>	16	\$677	<input type="checkbox"/>	18	\$677	<input type="checkbox"/>	20	\$677	<input type="checkbox"/>	20	\$677
Shoulder Height (SH)	21.0" (S)	J3PASHSxxFS	<input type="checkbox"/>	14	\$677	<input type="checkbox"/>	16	\$677	<input type="checkbox"/>	18	\$677	<input type="checkbox"/>	20	\$677	<input type="checkbox"/>	20	\$677
		J3PASHSxxTH	<input type="checkbox"/>	14	\$677	<input type="checkbox"/>	16	\$677	<input type="checkbox"/>	18	\$677	<input type="checkbox"/>	20	\$677	<input type="checkbox"/>	20	\$677
	22.5" (M)	J3PASHMxxFS	<input type="checkbox"/>	16	\$677	<input type="checkbox"/>	18	\$677	<input type="checkbox"/>	20	\$677	<input type="checkbox"/>	20	\$677	<input type="checkbox"/>	20	\$677
		J3PASHMxxTH	<input type="checkbox"/>	16	\$677	<input type="checkbox"/>	18	\$677	<input type="checkbox"/>	20	\$677	<input type="checkbox"/>	20	\$677	<input type="checkbox"/>	20	\$677
	24.0" (T)	J3PASHTxxFS	<input type="checkbox"/>	18	\$677	<input type="checkbox"/>	20	\$677	<input type="checkbox"/>	20	\$677	<input type="checkbox"/>	20	\$677	<input type="checkbox"/>	20	\$677
		J3PASHTxxTH	<input type="checkbox"/>	18	\$677	<input type="checkbox"/>	20	\$677	<input type="checkbox"/>	20	\$677	<input type="checkbox"/>	20	\$677	<input type="checkbox"/>	20	\$677

### FS Mounting Hardware

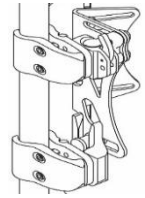

### JAY J3 Posterior Lateral (PL) BACK - 3" Contour Depth

Mid Thoracic (MT)	15.0" (T)	J3PLMTTxxFS	<input type="checkbox"/>	12	\$781	<input type="checkbox"/>	14	\$781	<input type="checkbox"/>	16	\$781	<input type="checkbox"/>	18	\$781	<input type="checkbox"/>	20	\$781
		J3PLMTTxxTH	<input type="checkbox"/>	12	\$781	<input type="checkbox"/>	14	\$781	<input type="checkbox"/>	16	\$781	<input type="checkbox"/>	18	\$781	<input type="checkbox"/>	20	\$781
Upper Thoracic (UT)	16.5" (S)	J3PLUTSxxFS	<input type="checkbox"/>	12	\$781	<input type="checkbox"/>	14	\$781	<input type="checkbox"/>	16	\$781	<input type="checkbox"/>	18	\$781	<input type="checkbox"/>	20	\$781
		J3PLUTSxxTH	<input type="checkbox"/>	12	\$781	<input type="checkbox"/>	14	\$781	<input type="checkbox"/>	16	\$781	<input type="checkbox"/>	18	\$781	<input type="checkbox"/>	20	\$781
	18.0" (M)	J3PLUTMxxFS	<input type="checkbox"/>	14	\$781	<input type="checkbox"/>	16	\$781	<input type="checkbox"/>	18	\$781	<input type="checkbox"/>	20	\$781	<input type="checkbox"/>	20	\$781
		J3PLUTMxxTH	<input type="checkbox"/>	14	\$781	<input type="checkbox"/>	16	\$781	<input type="checkbox"/>	18	\$781	<input type="checkbox"/>	20	\$781	<input type="checkbox"/>	20	\$781
	19.5" (T)	J3PLUTTxxFS	<input type="checkbox"/>	14	\$781	<input type="checkbox"/>	16	\$781	<input type="checkbox"/>	18	\$781	<input type="checkbox"/>	20	\$781	<input type="checkbox"/>	20	\$781
		J3PLUTTxxTH	<input type="checkbox"/>	14	\$781	<input type="checkbox"/>	16	\$781	<input type="checkbox"/>	18	\$781	<input type="checkbox"/>	20	\$781	<input type="checkbox"/>	20	\$781
Shoulder Height (SH)	21.0" (S)	J3PLSHSxxFS	<input type="checkbox"/>	14	\$781	<input type="checkbox"/>	16	\$781	<input type="checkbox"/>	18	\$781	<input type="checkbox"/>	20	\$781	<input type="checkbox"/>	20	\$781
		J3PLSHSxxTH	<input type="checkbox"/>	14	\$781	<input type="checkbox"/>	16	\$781	<input type="checkbox"/>	18	\$781	<input type="checkbox"/>	20	\$781	<input type="checkbox"/>	20	\$781
	22.5" (M)	J3PLSHMxxFS	<input type="checkbox"/>	16	\$781	<input type="checkbox"/>	18	\$781	<input type="checkbox"/>	20	\$781	<input type="checkbox"/>	20	\$781	<input type="checkbox"/>	20	\$781
		J3PLSHMxxTH	<input type="checkbox"/>	16	\$781	<input type="checkbox"/>	18	\$781	<input type="checkbox"/>	20	\$781	<input type="checkbox"/>	20	\$781	<input type="checkbox"/>	20	\$781
	24.0" (T)	J3PLSHTxxFS	<input type="checkbox"/>	18	\$781	<input type="checkbox"/>	20	\$781	<input type="checkbox"/>	20	\$781	<input type="checkbox"/>	20	\$781	<input type="checkbox"/>	20	\$781
		J3PLSHTxxTH	<input type="checkbox"/>	18	\$781	<input type="checkbox"/>	20	\$781	<input type="checkbox"/>	20	\$781	<input type="checkbox"/>	20	\$781	<input type="checkbox"/>	20	\$781

### TH Mounting Hardware

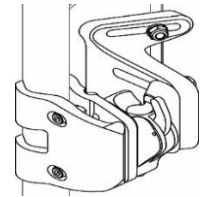

### JAY J3 Posterior Deep (PD) BACK - 6" Contour Depth

Mid Thoracic (MT)	15.0" (T)	J3PDMTTxxFS	<input type="checkbox"/>	12	\$928	<input type="checkbox"/>	14	\$928	<input type="checkbox"/>	16	\$928	<input type="checkbox"/>	18	\$928	<input type="checkbox"/>	20	\$928
		J3PDMTTxxTH	<input type="checkbox"/>	12	\$928	<input type="checkbox"/>	14	\$928	<input type="checkbox"/>	16	\$928	<input type="checkbox"/>	18	\$928	<input type="checkbox"/>	20	\$928
Upper Thoracic (UT)	18.0" (M)	J3PDUTMxxFS	<input type="checkbox"/>	14	\$928	<input type="checkbox"/>	16	\$928	<input type="checkbox"/>	18	\$928	<input type="checkbox"/>	20	\$928	<input type="checkbox"/>	20	\$928
		J3PDUTMxxTH	<input type="checkbox"/>	14	\$928	<input type="checkbox"/>	16	\$928	<input type="checkbox"/>	18	\$928	<input type="checkbox"/>	20	\$928	<input type="checkbox"/>	20	\$928
Shoulder Height (SH)	21.0" (S)	J3PDSHSxxFS	<input type="checkbox"/>	14	\$928	<input type="checkbox"/>	16	\$928	<input type="checkbox"/>	18	\$928	<input type="checkbox"/>	20	\$928	<input type="checkbox"/>	20	\$928
		J3PDSHSxxTH	<input type="checkbox"/>	14	\$928	<input type="checkbox"/>	16	\$928	<input type="checkbox"/>	18	\$928	<input type="checkbox"/>	20	\$928	<input type="checkbox"/>	20	\$928

### JAY J3 Back Whitmyer Headrest

#### AXYS Mount and Pad

<input type="checkbox"/>	J3HEDX8	E0955/E1033	AXYS Headrest with 8" Plush Pad	\$449,00
<input type="checkbox"/>	J3HEDX10	E0955/E1033	AXYS Headrest with 10" Plush Pad	\$449,00
<input type="checkbox"/>	J3HEDX14	E0955/E1033	AXYS Headrest with 14" Plush Pad	\$464,00
<input type="checkbox"/>	J3HEDXAAPN	E0955/E1033	AXYS with Adj-a-Plush Narrow Pad	\$566,00
<input type="checkbox"/>	J3HEDXAAPS	E0955/E1033	AXYS with Adj-a-Plush Std Pad	\$566,00

#### LINX Mount and Pad

<input type="checkbox"/>	J3HEDL8	E0955/E1033	LINX Headrest with 8" Plush Pad	\$520,00
<input type="checkbox"/>	J3HEDL10	E0955/E1033	LINX Headrest with 10" Plush Pad	\$520,00
<input type="checkbox"/>	J3HEDL14	E0955/E1033	LINX Headrest with 14" Plush Pad	\$535,00
<input type="checkbox"/>	J3HEDLAAPN	E0955/E1033	LINX with Adj-a-Plush Narrow Pad	\$637,00
<input type="checkbox"/>	J3HEDLAAPS	E0955/E1033	LINX with Adj-a-Plush Std Pad	\$637,00

### JAY J3 Back Laterals Swing Away Laterals With Pad - Pair

<input type="checkbox"/>	JLATA44PR	E0956/E1034	SwingAway Lat with 4"x4" Pad (PR)	\$910,00	<input type="checkbox"/>	JLATA64PR	E0956/E1034	SwingAway Lat with 6"x4" Pad (PR)	\$910,00
<input type="checkbox"/>	JLATA45PR	E0956/E1034	SwingAway Lat with 4"x5" Pad (PR)	\$910,00	<input type="checkbox"/>	JLATA65PR	E0956/E1034	SwingAway Lat with 6"x5" Pad (PR)	\$910,00
<input type="checkbox"/>	JLATA46PR	E0956/E1034	SwingAway Lat with 4"x6" Pad (PR)	\$910,00	<input type="checkbox"/>	JLATA66PR	E0956/E1034	SwingAway Lat with 6"x6" Pad (PR)	\$910,00



## JAY® Signature Series Cushions

Note: Not all sizes and configurations shown below, for full offering visit [www.sunrisemedical.com](http://www.sunrisemedical.com).  
When ordering mark the part number desired and it will be added to the order as a separate line item .

### JAY CUSHIONS

JAY Fusion Cushion			
<input type="checkbox"/>	JFUSION1416	E2622	JAY Fusion 14" x 16" \$515,00
<input type="checkbox"/>	JFUSION1616	E2622	JAY Fusion 16" x 16" \$515,00
<input type="checkbox"/>	JFUSION1618	E2622	JAY Fusion 16" x 18" \$515,00
<input type="checkbox"/>	JFUSION1620	E2622	JAY Fusion 16" x 20" \$515,00
<input type="checkbox"/>	JFUSION1717	E2622	JAY Fusion 17" x 17" \$515,00
<input type="checkbox"/>	JFUSION1816	E2622	JAY Fusion 18" x 16" \$515,00
<input type="checkbox"/>	JFUSION1818	E2622	JAY Fusion 18" x 18" \$515,00
<input type="checkbox"/>	JFUSION1820	E2622	JAY Fusion 18" x 20" \$515,00
<input type="checkbox"/>	JFUSION2018	E2622	JAY Fusion 20" x 18" \$515,00
<input type="checkbox"/>	JFUSION2020	E2622	JAY Fusion 20" x 20" \$515,00
<input type="checkbox"/>	JFUSION2220	E2623	JAY Fusion 22" x 20" \$612,00

JAY J2 Cushion			
<input type="checkbox"/>	2108-MJ	E2622	JAY J2 14" x 16" \$524,00
<input type="checkbox"/>	2105-MJ	E2622	JAY J2 15.5" x 16" \$524,00
<input type="checkbox"/>	2106-MJ	E2622	JAY J2 15.5" x 18" \$524,00
<input type="checkbox"/>	2107-MJ	E2622	JAY J2 15.5" x 20" \$553,00
<input type="checkbox"/>	2117-MJ	E2622	JAY J2 17" x 17" \$524,00
<input type="checkbox"/>	2100-MJ	E2622	JAY J2 18" x 16" \$524,00
<input type="checkbox"/>	2101	E2622	JAY J2 18" x 18" \$524,00
<input type="checkbox"/>	2103-MJ	E2622	JAY J2 18" x 20" \$554,00
<input type="checkbox"/>	2118-MJ	E2622	JAY J2 20" x 18" \$554,00
<input type="checkbox"/>	2102-MJ	E2622	JAY J2 20" x 20" \$641,00

JAY Fusion Cushion w/ Single Valve Air Insert			
<input type="checkbox"/>	JFUSION1416AS	E2622	JAY Fusion 14" x 16" \$578,00
<input type="checkbox"/>	JFUSION1616AS	E2622	JAY Fusion 16" x 16" \$578,00
<input type="checkbox"/>	JFUSION1618AS	E2622	JAY Fusion 16" x 18" \$578,00
<input type="checkbox"/>	JFUSION1620AS	E2622	JAY Fusion 16" x 20" \$578,00
<input type="checkbox"/>	JFUSION1717AS	E2622	JAY Fusion 17" x 17" \$578,00
<input type="checkbox"/>	JFUSION1816AS	E2622	JAY Fusion 18" x 16" \$578,00
<input type="checkbox"/>	JFUSION1818AS	E2622	JAY Fusion 18" x 18" \$578,00
<input type="checkbox"/>	JFUSION1820AS	E2622	JAY Fusion 18" x 20" \$578,00
<input type="checkbox"/>	JFUSION2018AS	E2622	JAY Fusion 20" x 18" \$578,00
<input type="checkbox"/>	JFUSION2020AS	E2622	JAY Fusion 20" x 20" \$578,00
<input type="checkbox"/>	JFUSION2220AS	E2623	JAY Fusion 22" x 20" \$674,00

JAY J2 Deep Contour Cushion			
<input type="checkbox"/>	2446	E2622	JAY J2 Deep Contour 14" x 16" \$537,00
<input type="checkbox"/>	2466	E2622	JAY J2 Deep Contour 16" x 16" \$537,00
<input type="checkbox"/>	2468	E2622	JAY J2 Deep Contour 16" x 18" \$537,00
<input type="checkbox"/>	2460	E2622	JAY J2 Deep Contour 16" x 20" \$549,00
<input type="checkbox"/>	2477	E2622	JAY J2 Deep Contour 17" x 17" \$537,00
<input type="checkbox"/>	2486	E2622	JAY J2 Deep Contour 18" x 16" \$537,00
<input type="checkbox"/>	2488	E2622	JAY J2 Deep Contour 18" x 18" \$537,00
<input type="checkbox"/>	2480	E2622	JAY J2 Deep Contour 18" x 20" \$561,00
<input type="checkbox"/>	2408	E2622	JAY J2 Deep Contour 20" x 18" \$561,00
<input type="checkbox"/>	2400-MJ	E2622	JAY J2 Deep Contour 20" x 20" \$677,00
<input type="checkbox"/>	2428	E2623	JAY J2 Deep Contour 22" x 18" \$677,00

JAY Fusion Cushion w/ Dual Valve Air Insert			
<input type="checkbox"/>	JFUSION1416AD	E2622	JAY Fusion 14" x 16" \$583,00
<input type="checkbox"/>	JFUSION1616AD	E2622	JAY Fusion 16" x 16" \$583,00
<input type="checkbox"/>	JFUSION1618AD	E2622	JAY Fusion 16" x 18" \$583,00
<input type="checkbox"/>	JFUSION1620AD	E2622	JAY Fusion 16" x 20" \$583,00
<input type="checkbox"/>	JFUSION1717AD	E2622	JAY Fusion 17" x 17" \$583,00
<input type="checkbox"/>	JFUSION1816AD	E2622	JAY Fusion 18" x 16" \$583,00
<input type="checkbox"/>	JFUSION1818AD	E2622	JAY Fusion 18" x 18" \$583,00
<input type="checkbox"/>	JFUSION1820AD	E2622	JAY Fusion 18" x 20" \$583,00
<input type="checkbox"/>	JFUSION2018AD	E2622	JAY Fusion 20" x 18" \$583,00
<input type="checkbox"/>	JFUSION2020AD	E2622	JAY Fusion 20" x 20" \$583,00
<input type="checkbox"/>	JFUSION2220AD	E2623	JAY Fusion 22" x 20" \$680,00

JAY X2 Cushion			
<input type="checkbox"/>	JX21416	E2622	JAY X2 14" x 16" \$501,00
<input type="checkbox"/>	JX21616	E2622	JAY X2 16" x 16" \$501,00
<input type="checkbox"/>	JX21618	E2622	JAY X2 16" x 18" \$501,00
<input type="checkbox"/>	JX21620	E2622	JAY X2 16" x 20" \$501,00
<input type="checkbox"/>	JX21717	E2622	JAY X2 17" x 17" \$501,00
<input type="checkbox"/>	JX21816	E2622	JAY X2 18" x 16" \$501,00
<input type="checkbox"/>	JX21818	E2622	JAY X2 18" x 18" \$501,00
<input type="checkbox"/>	JX21820	E2622	JAY X2 18" x 20" \$501,00
<input type="checkbox"/>	JX22020	E2622	JAY X2 20" x 20" \$501,00

JAY Union Cushion			
<input type="checkbox"/>	JU1416	E2607	JAY UNION 14" x 16" \$520,00
<input type="checkbox"/>	JU1616	E2607	JAY UNION 16" x 16" \$520,00
<input type="checkbox"/>	JU1618	E2607	JAY UNION 16" x 18" \$520,00
<input type="checkbox"/>	JU1620	E2607	JAY UNION 16" x 20" \$520,00
<input type="checkbox"/>	JU1717	E2607	JAY UNION 17" x 17" \$520,00
<input type="checkbox"/>	JU1816	E2607	JAY UNION 18" x 16" \$520,00
<input type="checkbox"/>	JU1818	E2607	JAY UNION 18" x 18" \$520,00
<input type="checkbox"/>	JU1820	E2607	JAY UNION 18" x 20" \$520,00
<input type="checkbox"/>	JU2018	E2607	JAY UNION 20" x 18" \$520,00
<input type="checkbox"/>	JU2020	E2607	JAY UNION 20" x 20" \$520,00
<input type="checkbox"/>	JU2220	E2608	JAY UNION 22" x 20" \$635,00

JAY Ion Cushion			
<input type="checkbox"/>	JION1416	E2607	JAY ION 14" x 16" \$462,00
<input type="checkbox"/>	JION1616	E2607	JAY ION 16" x 16" \$462,00
<input type="checkbox"/>	JION1618	E2607	JAY ION 16" x 18" \$462,00
<input type="checkbox"/>	JION1620	E2607	JAY ION 16" x 20" \$462,00
<input type="checkbox"/>	JION1717	E2607	JAY ION 17" x 17" \$462,00
<input type="checkbox"/>	JION1816	E2607	JAY ION 18" x 16" \$462,00
<input type="checkbox"/>	JION1818	E2607	JAY ION 18" x 18" \$462,00
<input type="checkbox"/>	JION1820	E2607	JAY ION 18" x 20" \$462,00
<input type="checkbox"/>	JION2018	E2607	JAY ION 20" x 18" \$462,00
<input type="checkbox"/>	JION2020	E2607	JAY ION 20" x 20" \$462,00
<input type="checkbox"/>	JION2220	E2608	JAY ION 22" x 20" \$578,00

JAY Union Reduced Profile Cushion			
<input type="checkbox"/>	JU1416RP	E2607	JAY Union RP 14" x 16" \$520,00
<input type="checkbox"/>	JU1616RP	E2607	JAY Union RP 16" x 16" \$520,00
<input type="checkbox"/>	JU1618RP	E2607	JAY Union RP 16" x 18" \$520,00
<input type="checkbox"/>	JU1620RP	E2607	JAY Union RP 16" x 20" \$520,00
<input type="checkbox"/>	JU1717RP	E2607	JAY Union RP 17" x 17" \$520,00

<input type="checkbox"/>	JU1816RP	E2607	JAY Union RP 18" x 16" \$520,00
<input type="checkbox"/>	JU1818RP	E2607	JAY Union RP 18" x 18" \$520,00
<input type="checkbox"/>	JU1820RP	E2607	JAY Union RP 18" x 20" \$520,00
<input type="checkbox"/>	JU2018RP	E2607	JAY Union RP 20" x 18" \$520,00
<input type="checkbox"/>	JU2020RP	E2607	JAY Union RP 20" x 20" \$520,00



Sunrise Medical (US) LLC  
12002 Volunteer Blvd. Mount Juliet, TN 37122