

ASSEMBLY INSTRUCTION

Incontinence cover

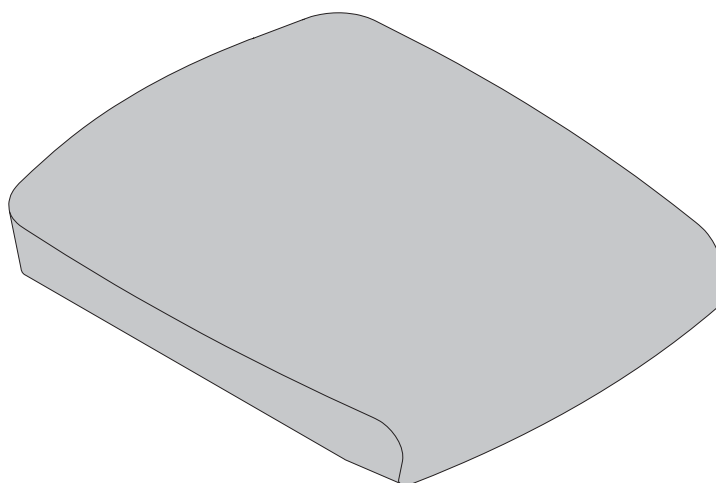

Description	Item no.
Incontinence cover SB39	<input type="checkbox"/> 3509017
Incontinence cover SB42	<input type="checkbox"/> 3509018
Incontinence cover SB45	<input type="checkbox"/> 3509019
Incontinence cover SB48	<input type="checkbox"/> 3509020
Incontinence cover SB51	<input type="checkbox"/> 3509021
Incontinence cover SB54	<input type="checkbox"/> 3509022



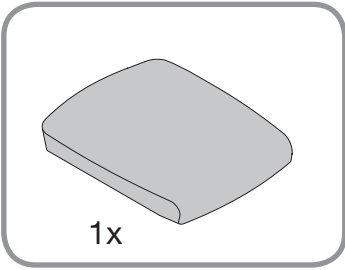

1

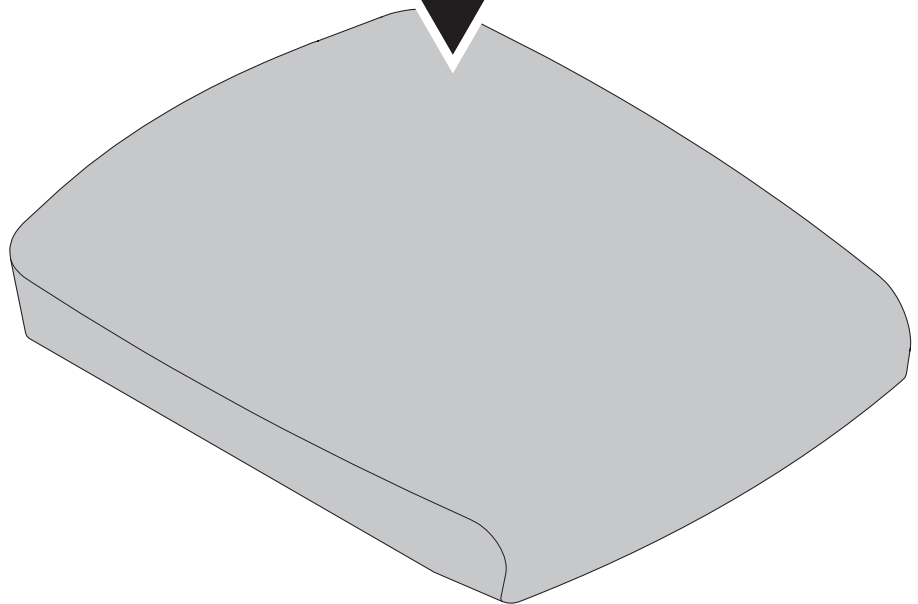
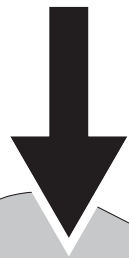
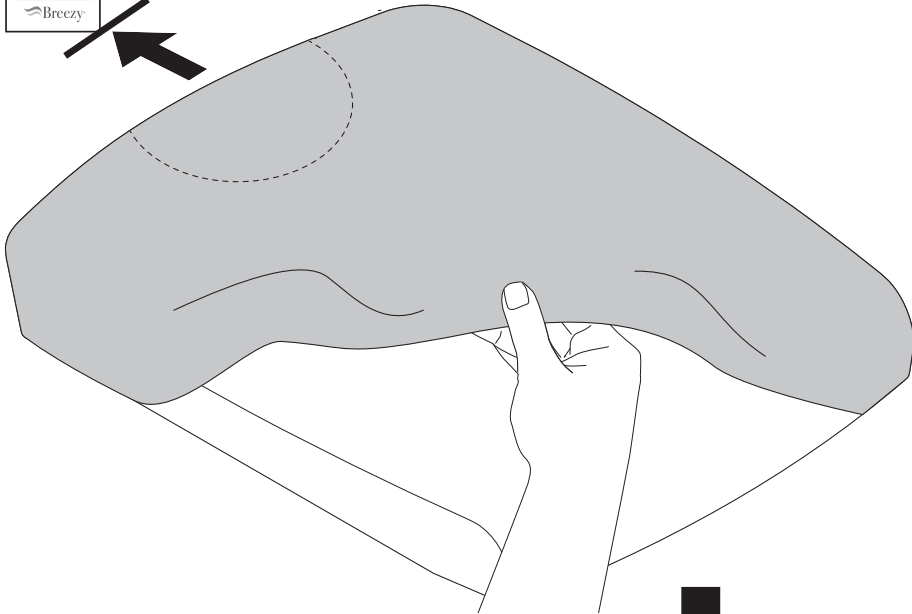
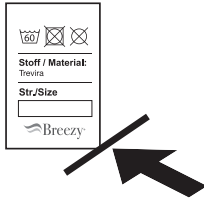

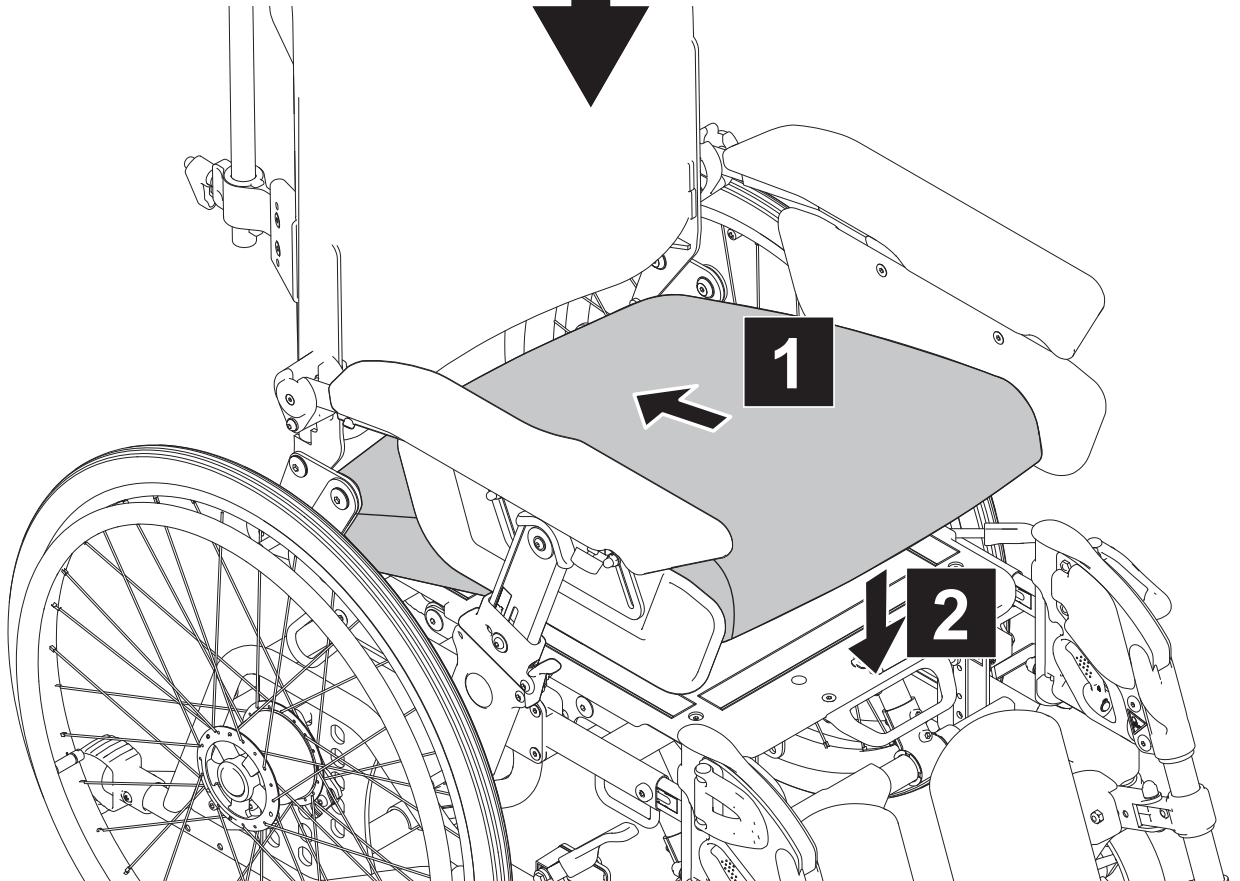
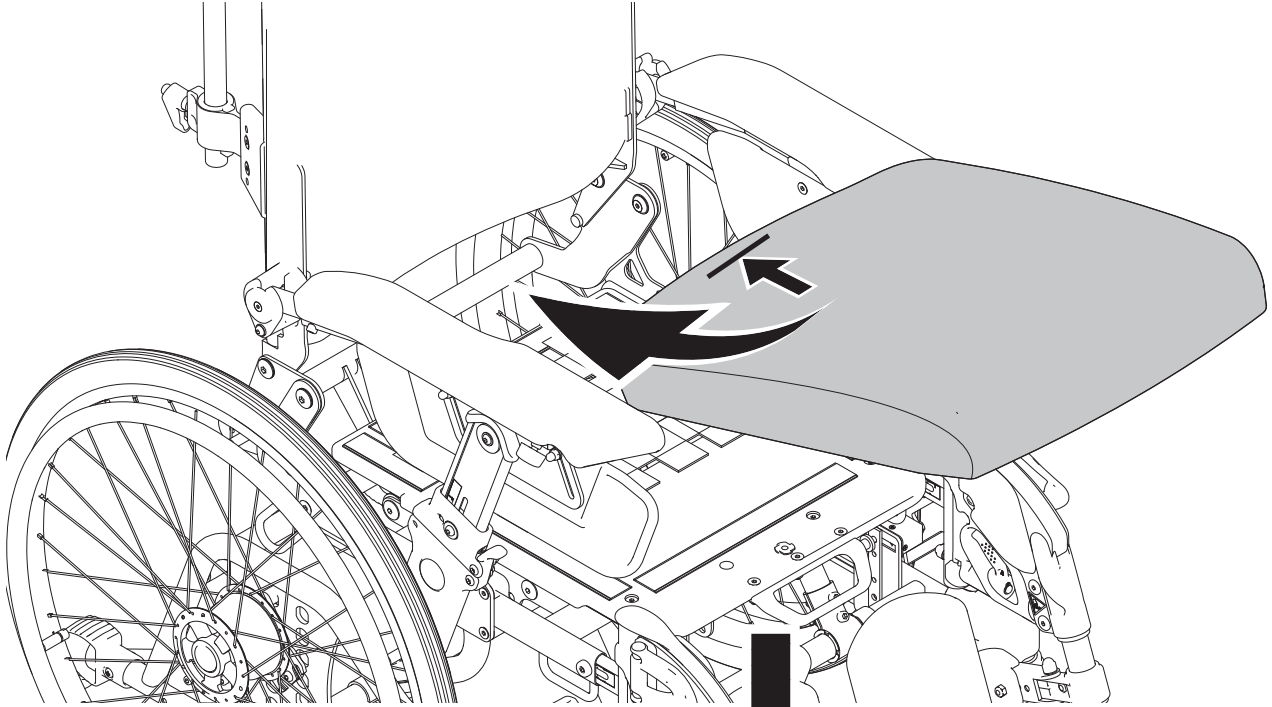

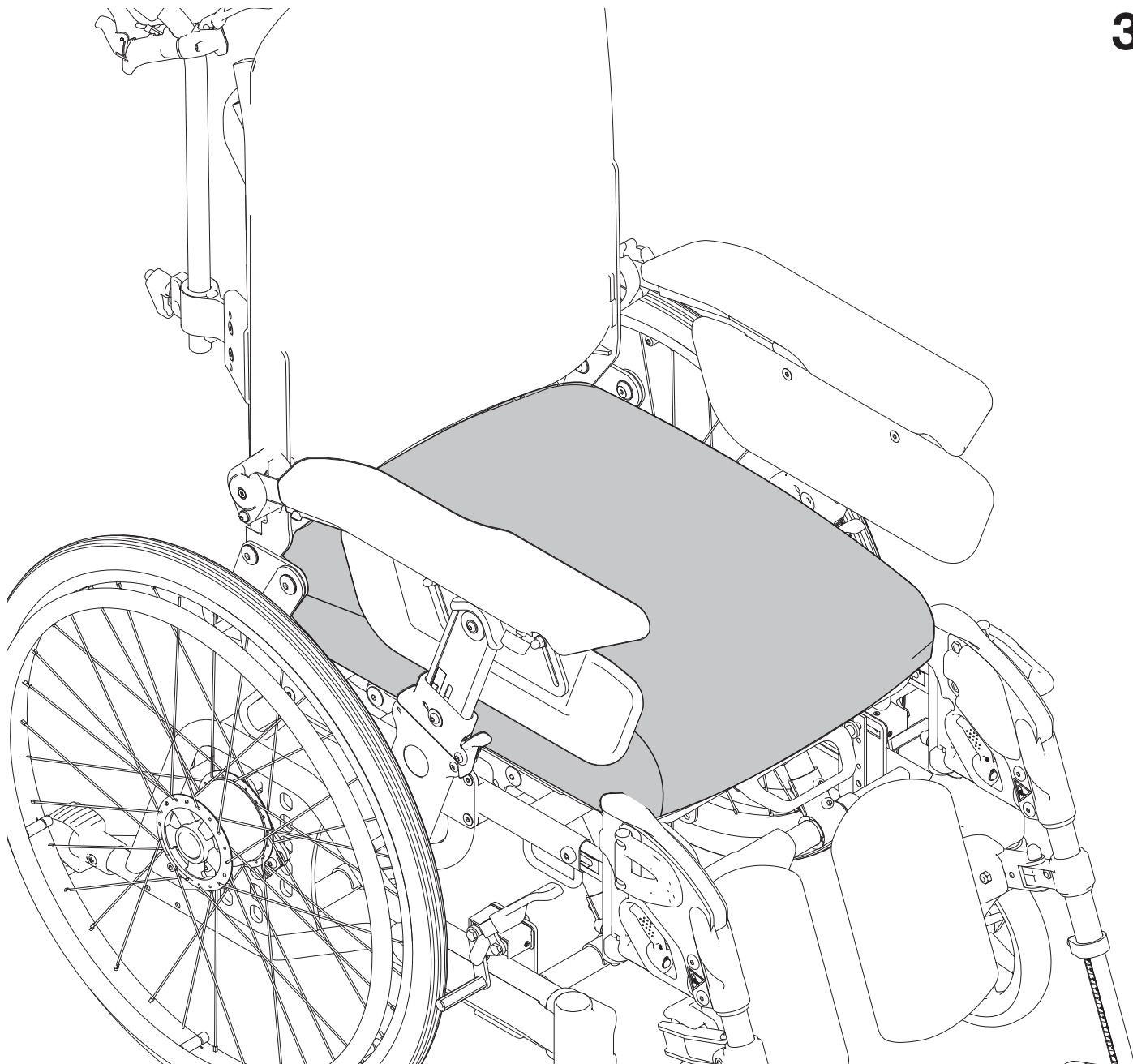

Sunrise Medical AS
Delitoppen 3
1540 Vestby
Norway
T: +47 66963800
E: post@sunrisemedical.no
www.SunriseMedical.no