



**Customer Contact Details**

Customer Name: _____ Advisor: _____ Address: _____ _____ _____ Phone: _____ Email: _____	Ship to Customer Address: <input type="checkbox"/> Shipping Name: _____ Shipping Address: _____ _____ _____ Phone: _____ Email: _____
--	---

**Additional Information**

Notes: _____ _____ _____ _____	Current Wheelchair: _____ Customer Weight: _____ Customer Height: _____ Customer Disability: _____
---	---

**Other**

<p><b>VAT Exemption Declaration (UK Only):</b>                  I declare that I am chronically sick or disabled by reason of:                  _____                  and that I am receiving from RGK Wheelchairs Ltd, the wheelchair specified herein and I claim relief from Value Added Tax under group 12 of schedule 8 to Value Added Tax Act 1994.                  Signature: _____ Date: _____</p>	<p><b>RGK Contact Authorisation:</b>                  From time to time, RGK would like to send you exclusive information, news and offers on everything RGK, by email or post. We will not pass any of your details to any third party.                  I would like to be contacted by RGK: <input type="checkbox"/>                  Signature: _____ Date: _____</p>
--	---

Guide:  Base product  Required option  Optional Extra  Critical Information  Information Needed  Non certified Sub4 weight option

**PRODUCT STYLE**

**SBTXZ010 OCTANE SUB4**

**XA070** Open design

**Max User Weight 110kg (242lbs)**

**PLEASE NOTE: ALL RGK CHAIRS ARE HAND BUILT AND HAVE A MANUFACTURING MEASUREMENT TOLERANCE OF +/- 5MM**

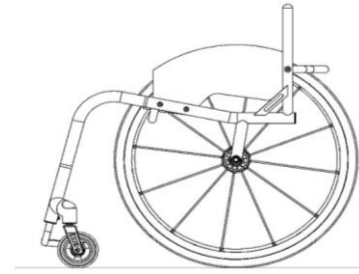

**XW009** QUOTE ONLY (NO CAD FOR APPROVAL)

**XW011** ORDER (NO CAD FOR APPROVAL)

**XW012** QUOTE CAD drawing for approval (2 customer amendments ONLY)

**XW010** ORDER CAD drawing for approval (2 customer amendments ONLY)

**KEY MEASUREMENTS**

**XY010** Seat width (*Inside of sideguards*)  
  (Max - 440mm) (Min - 250mm)

**XY020** Seat length  
  (Max - 440mm) (Min - 250mm)

**XY030** Extra seat length (*Provides additional leg support & hand grip*)  
  (Max - 440mm total seat)

**XY050** Front frame height  
  (Max - 520mm) (Min - 380mm)

**XY060** Rear frame height  
  (Max - 500mm) (Min - 360mm)

**XY070** Frame length  
  (Max - 625mm) (Min = XY020 + XY030 + 140mm)

**XY072** Castor position  
   
 *Optimise measurements*

**XA020** Ergonomic seat  
 Specify length  (Standard = 120mm)

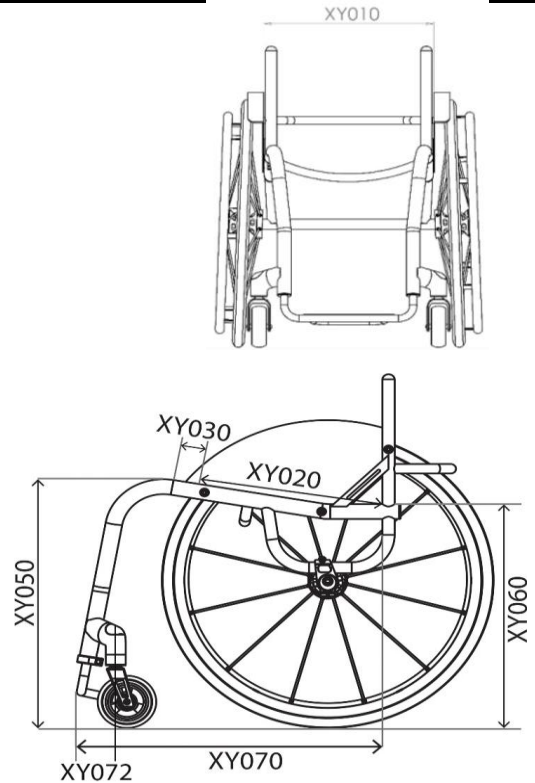

**FRONT FRAME AND FOOTREST**

Front Frame Options

XY080 Seat taper design

XY091 Parallel taper design

**i** Specify width  mm

(When combined with XY091, dimension is inbetween the centre of the main bends)

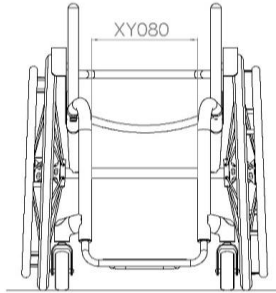

**i** Specify width  mm

(When combined with XY080, dimensions must be smaller by 20mm)

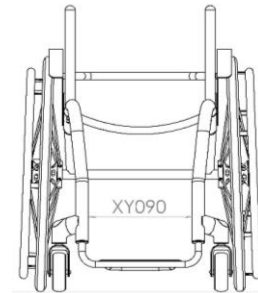

Footrest Design Choose One)

XY100 Round design

XY105 Square design

Castor Wheel Size	Max Height Achievable
4"	110mm

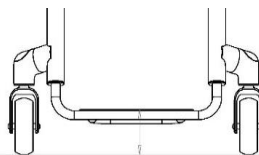

Castor Wheel Size	Max Height Achievable
4"	130mm

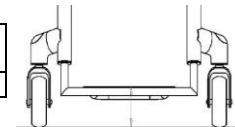

Footrest Measurements

XY115 Front footrest height  mm

XY120 Rear footrest height  mm

Std = 20 lower than front height

XY125 Footrest length  mm

Maximum length 140mm (Certified weight)  
(160mm and over requires heavy duty upgrade XB150)

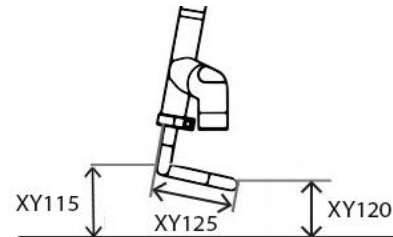

XB200 High level footrest (Non-certified Sub4 option)

Indicate front footrest height:  mm

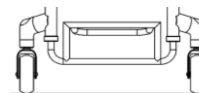

Footrest Style

XB025 Tubular Titanium footrest Sub4 (Height adjustable) (Std if no option selected)

XB020 Tubular Titanium footrest (Non Sub4) (Height adjustable) (Non Certified Sub4 option)

Footrest Cover

XB045 Lightweight carbon fibre cover (With weight saving cut-out)

Footplate width Sub4 certified (Std if no option selected)

No Cut-Out (Non Certified Sub4 option)

Footplate width Standard (optimised plate width) (Non Certified Sub4 option)

**CASTOR WHEELS, FORKS & WHEEL LOCKS**

**Castor Wheels**

XC135 Aluminium centre 4"x1.25"  
Choose colour below:

Silver hub & black tyre (Std)       Green hub & black tyre

Black hub & black tyre       Red hub & black tyre

Purple hub & black tyre       Blue hub & black tyre

SBTXC155 Forged carbon centre 4"x1.4" **(Non certified Sub4 option)**

XC140 Aluminium centre 5"x1.4" **(Non certified Sub4 option)**  
*(Silver hub and black tyre only)*

XC145 Aluminium centre 6"x1.4" **(Non certified Sub4 option)**  
*(Silver hub and black tyre only)*

**Castor Forks**

XC190 Performance castor fork **(Std)**  
*Note: Colour follows accent*

XC192 High trail castor fork  
*Note: Greater distance between contact patch and steering axis reduces flutter at higher speeds. Colour follows accent*

**Castor Pin Width**

XY330 Castor pin width

Optimise measurements  
*(Minimum width for clear castor rotation and maximum wheelbase length)*

**Wheel Lock Options**

SBTXD036 Compact scissor with lightweight fixing

XD020 Underseat scissor **(Non certified Sub4 option)**

XD050 Push to lock **(Non certified Sub4 option)**

XD010 Omit wheel locks

SBTXD085 Eagle wheel lockss (Indicate colour) **(Non Certified Sub4 option)**

SBTXD086 Eagle WL with L/W fixing (Indicate colour) *(Only with fixed centre of gravity)* **(Non Certified Sub4 option)**

BLACK     PURPLE     RED     BLUE  
**Black Std if no option selected**

**SIDEGUARDS**

**Sideguard**

XE055 Screw on lightweight carbon fibre

**Sideguard with Fender**

XE065 Screw on lightweight carbon fibre w/fender

**Sideguard Measurements**

Individual above tyre *(Follow tyre - max. 25mm)*

mm

Level with tyre *(Follow tyre)*

**Sideguard Measurements**

10mm above tyre *(Standard)*

Individual above tyre *(Min = 10mm)*

mm

Centre of tyre

BACKREST	
Backrest Measurements	
<input checked="" type="checkbox"/> XY230 Backrest height Specify height <input style="width: 100px;" type="text"/> mm 	<input type="checkbox"/> XG010 Fixed Backrest (non-folding) <input checked="" type="checkbox"/> SBTXG020 Folding backrest with 2 position snap lock and angle adjust <b>(Non certified Sub4 option)</b>
Ergonomic Options	
<input checked="" type="checkbox"/> XY360 Backrest angle -5 <input type="checkbox"/> -3 <input type="checkbox"/> 0 <input type="checkbox"/> +3 <input type="checkbox"/> +5 Individual <input style="width: 100px;" type="text"/> Deg (Max -10/+20 Deg) 	<input type="checkbox"/> XG100 Ergonomic backrest Vertical height <input style="width: 100px;" type="text"/> mm Rearward position <input style="width: 100px;" type="text"/> mm <input type="checkbox"/> XG110 Inward taper (inside of backrest posts) Specify width or per side <input style="width: 100px;" type="text"/> mm 
<input type="checkbox"/> XG110 Inward taper (inside of backrest posts) Specify width or per side <input style="width: 100px;" type="text"/> mm 	<input type="checkbox"/> XG120 Outward flare (inside of backrest posts) Specify width or per side <input style="width: 100px;" type="text"/> mm 
CAMBER BAR	
Specify Camber Angle	Centre of Gravity
<input checked="" type="checkbox"/> XY390 Camber angle 1 <input type="checkbox"/> 2 <input type="checkbox"/> 3	<input type="checkbox"/> SBTXH100 Single post fixed centre of gravity (25-125mm) <input style="width: 100px;" type="text"/> mm 
	<input checked="" type="checkbox"/> SBTXH130 Square back adjustable centre of gravity (25-125mm) <b>(Non Certified Sub4 option)</b> <input style="width: 100px;" type="text"/> mm
	<input checked="" type="checkbox"/> SBTXH140 Round back adjustable centre of gravity (60-125mm) <b>(Non Certified Sub4 option)</b> <input style="width: 100px;" type="text"/> mm
PUSH HANDLES	
<input checked="" type="checkbox"/> XG070 Screw in push handles <b>(Non Certified Sub4 option)</b>	<input checked="" type="checkbox"/> XG080 Flip down push handles <b>(Non Certified Sub4 option)</b>
ANTI-TIP	
<input checked="" type="checkbox"/> XJ100 Single sport anti tip <b>(Non Certified Sub4 option)</b>	

FRAME FINISH OPTIONS			
Frame and Footrest (Choose One)			
<input type="checkbox"/> SBTXN030	Bead Blast frame	<input checked="" type="checkbox"/> XN010	Powder coat frame
<input type="checkbox"/> SBTXN050	Polished frame	Paint code	<input style="width: 100px; height: 20px;" type="text"/>
Accent Colour (Choose One)			
<i>Note: Accent colour includes, forks &amp; castor caps.</i>			
<input type="checkbox"/>	Black accent	<input type="checkbox"/>	Silver accent
<input checked="" type="checkbox"/>	Red accent	<input type="checkbox"/>	Blue accent
<input type="checkbox"/>	Purple accent	<input type="checkbox"/>	Carbon accent <i>(Castor caps only, black for rest)</i>
		<input type="checkbox"/> XN250	Individual Accent Colour €165,00
UPHOLSTERY			
Seat Upholstery			
<input type="checkbox"/> XP045	Sub4 Seat sling strap adjustable	<input checked="" type="checkbox"/> XR050	Carbon fibre seat plate <b>(Non certified Sub4 option)</b>
Backrest Upholstery			
<input type="checkbox"/> XP035	Airtech Sub4 backrest strap adjustable	<input checked="" type="checkbox"/> XP050	Airtech backrest strap adjustable <b>(Non certified Sub4 option)</b>
		<input checked="" type="checkbox"/> XP070	Backrest upgrade to leather corners (Black) <i>(only with Airtech upholstery XP050)</i> <b>(Non certified Sub4 option)</b>
		<input checked="" type="checkbox"/> XP110	Backrest with zip pocket <i>(only with Airtech upholstery XP050)</i> <b>(Non certified Sub4 option)</b>
		<input checked="" type="checkbox"/> XP170	Individual backrest embroidery <i>Please complete page 9</i> <b>(only with Airtech upholstery XP050)</b>
Backrest Upholstery Stitching Options			
<input type="checkbox"/>	Silver	<input type="checkbox"/>	Black
<input type="checkbox"/>	Red	<input type="checkbox"/>	Orange
<input type="checkbox"/>		<input type="checkbox"/>	Blue
<input type="checkbox"/>		<input type="checkbox"/>	Purple
		<input type="checkbox"/>	Individual: _____
RGK Logo Colour			
<input type="checkbox"/>	White (Std)	<input type="checkbox"/>	Black
<input type="checkbox"/>	Red	<input type="checkbox"/>	Orange
<input type="checkbox"/>		<input type="checkbox"/>	Blue
<input type="checkbox"/>		<input type="checkbox"/>	Purple
		<input type="checkbox"/>	Individual: _____



(A) REAR WHEELS (* non certified weight options)	
Rear Wheel Size	
<input type="checkbox"/> XY420 24" Wheels	<input type="checkbox"/> XY430 25" Wheels
Rear Wheel Gap	
<input checked="" type="checkbox"/> XY460 Rear wheel gap <input type="checkbox"/> 15 <input type="checkbox"/> 20 <input type="checkbox"/> 25	XY460 
Rear Wheel Options	
<input type="checkbox"/> XK075 Spinerigy <b>BLXL</b> 18 blade spoke <i>N/A IN SILVER HUB</i>	<input type="checkbox"/> SBTXK150 Spinerigy <b>CLX</b> 18 carbon blade spoke <i>N/A IN SILVER HUB</i>
<input checked="" type="checkbox"/> XK226 Titanium 100mm quick release axle pins	
<b>Spinerigy Colour Options:</b>	
<input type="checkbox"/> Black spokes <input type="checkbox"/> White spokes <input type="checkbox"/> Yellow spokes <input type="checkbox"/> Red spokes <input type="checkbox"/> Blue spokes <input type="checkbox"/> Pink spokes <input type="checkbox"/> Purple spokes <input type="checkbox"/> Orange spokes <input type="checkbox"/> Green spokes	<input type="checkbox"/> XK180 Individual spoke design <i>(Specify colour)</i>  Inside: _____  Outside: _____
<b>Spinerigy Anodise Options</b>	
<input type="checkbox"/> XK190 Black hub <i>(std option)</i>	<input type="checkbox"/> XK200 Silver hub <i>(n/a with BLXL/CLX)</i>
<input type="checkbox"/> XK202 Purple hub/rims <i>(LX, XLX &amp; BLXL only)</i>	<input type="checkbox"/> XK203 Blue hub/rims <i>(LX, XLX &amp; BLXL only)</i>
<input type="checkbox"/> XK201 Red hub/rims <i>(LX, XLX &amp; BLXL only)</i>	<input type="checkbox"/> XK204 Gold hub/rims <i>(LX, XLX &amp; BLXL only)</i>
	<input type="checkbox"/> XK205 Individual hub/rims <b>€304,00</b> Select colour: _____
Supply Without Wheels	
<input type="checkbox"/> SBTXK040 Supply without Wheels	Wheel Type: <input style="width: 150px;" type="text"/> Tyre Type: <input style="width: 150px;" type="text"/>
Handrim Position / Options	
<input type="checkbox"/> XY480 Narrow set handrim	<input type="checkbox"/> XY485 Wide set handrim
<input type="checkbox"/> XL090 Remove excess mounting tabs <i>(recommended for small wheel gaps)</i>	
Handrim Styles	
<input type="checkbox"/> XL010 Aluminium hard anodised 6 tab <i>(Standard if no option selected)</i>	<input type="checkbox"/> XL040 Titanium 6 tab
<input type="checkbox"/> XL160 Elipse 6 tab <i>(replacement for Surge)</i>	<input type="checkbox"/> XL035 Natural Fit LT
<input type="checkbox"/> XL020 Tetra grip 6 tab	<input type="checkbox"/> XL150 Carbolife Gekko <input type="checkbox"/> Black <input type="checkbox"/> Silver
<input type="checkbox"/> XL100 Para grip 6 tab	<input type="checkbox"/> XL170 Carbolife Curve L <i>(Black)</i>
Tyre Options	
<input type="checkbox"/> XM060 Schwalbe One (Lightest option)	<input type="checkbox"/> XM130 Kenda black
<input type="checkbox"/> XM010 Kenda <input type="checkbox"/> Grey <input type="checkbox"/> Blue <input type="checkbox"/> Red	<input type="checkbox"/> XM050 Kenda K885 mountain bike tyre <i>(24", 25" only)</i> <i>(24", 25" only)</i>
<input type="checkbox"/> XM020 Schwalbe Marathon Plus	
<input type="checkbox"/> XM040 Shox solid airless	
Inner Tube Valve Options	
<input type="checkbox"/> XY500 Schraeder inner tube valve <i>(Standard if no option selected)</i>	<input type="checkbox"/> XY490 Presta inner tube valve

\* Indicates items that are not part of the certified weight of the Tiga Sub4



4 **CUSHION (\*\* non certified weight options)**

Cushion foam options

XP080 Cushion foam  
*(select density and size below)*

<input type="checkbox"/> Soft (CMS040)	<input type="checkbox"/> Medium (CMS050)	
<input type="checkbox"/> 50mm	<input type="checkbox"/> 75mm	<input type="checkbox"/> 100mm

Cushion cover upgrades

XP085 Nylon cushion cover  
*(Black)*

XP090 Airlite cushion cover  
*(Black)*

XP100 Leather cushion cover  
*(Black)*

Jay Products - PLEASE PROVIDE JAY ORDER FORM

<input type="checkbox"/> JAY Cushion <i>(Price dependant on size / option)</i>	
<input type="checkbox"/> JAY Backrest <i>(Price dependant on size / option)</i>	
<input type="checkbox"/> JAY Whitmyer Headrest <i>(Price dependant on size / option)</i>	

4 **FRAME OPTIONS (\*\* non certified weight options)**

XR060 Welded calf strap mounting loops  
*(To locate calf strap on front frame)*

*Specify height from floor*

Optimise measurements

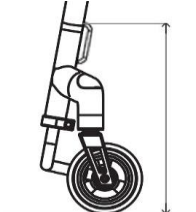

4 **ACCESSORIES (\*\* non certified weight options)**

XR080 Frontwheel assembly  
*(Only with XB010, TGAXB080, XB150)*

XP120 Frame protectors Neoprene zip fasten (Black)

XP420 Frame protectors Nylon velcro fasten (Black)

XR010 Seat pouch velcro attach *(Black)*

XR200 Rucksack with RGK logo (Black)

XR090 Tool kit

XS065 Sub4 Calf Strap

\*\* indicates options that, when chosen, will not enable RGK to guarantee a Sub4kg product weight

**ADDITIONAL NOTES**

**INDIVIDUAL BACKREST EMBROIDERY**

PLEASE PROVIDE JPEG IMAGE AT TIME OF ORDER AND NOTE POSITION BELOW



**BRACE BAR**

**SPEC NOTES:**

**OFF SPEC REQUEST\*** *(please specify below the page number(s) and details to which the off spec request applies.*

**OFF SPEC REQUEST APPROVED** *(for internal RGK office only)*

**X**  
*RGK Internal Sign-off*

Off spec requests require a feasibility study which may increase order price and lead time. Any dimension/ option/ frame request not listed on the order form will be treated as an off spec request.\*