



Count on us to care





Count on us to care

When mobility is compromised, when care and assistance are necessary, that's when you need support to rely on. That's Coopers. Products that make it more comfortable and safe your day.

Our highest priority is trust. Coopers is the brand of products related to care and professional or home care. Count on Coopers. We take care of you

Index



1
Movility

Walkers	4-8
Rollators	9-11
Crutches and sticks	12-21



2
Toileting

Stacking Commode	22-25
Urinals	26-27



3
Bathroom

Showerchairs	28
Showerboards	28
Bathseats & bathboards	29-31
Hair washing tray	31

4
Bedroom Aids & Rehab

Incorporators	32
Tables	32
Pedaliar	32
Dropper support	33
Handrail	33



6
Households

Antidecubitus mattress	34-35
Stocking and shoe aids	36-37



Movility Walkers



Steel walker with wheels

Code. A136

Foldable painted steel walker, adjustable in height from 78 to 98 cm. Independent regulation handles. Color: silver gray.

Adjustable height	77,5 a 98 cm
Width	56,5 cm
Length	66 cm
Max user weight	100 kg



Foldable aluminum walker

Code. A504

Foldable aluminum walker with 25 mm tube. Strong, standardise for users up to 127 kg.

Adjustable height	79 a 96 cm
Front width	57 cm
Rear width	58 cm
Length	46 cm
Max user weight	130 kg



Steel walker with wheels and seat

Code. A514

Painted, folding and with removable seat steel walker. Adjustable in height from 78 to 98 cm. Independent regulation handles. Color: silver gray. Seat: 22 x 39 cm

Adjustable height	77,5 a 98 cm
Width	56,5 cm
Length	66 cm
Height from the seat to floor	65,5 cm
Max user weight	100 kg



Wander walker

Code. A505

Aluminum folding walker with reciprocal movement with 25mm tube. Strong, standardise for users up to 127 kg.

Adjustable height	79 a 96 cm
Front width	50 cm
Rear width	52 cm
Length	50 cm
Max user weight	120 kg

Movility Walkers



Hospital Walking Frame

Specifically designed for use in hospitals and nursing homes.

Lightweight height adjustable aluminium frame
Features extra-wide base for additional stability

Coopers Product Code	TCES Code Number	Coopers Product Name	Technical Specification	Max User Weight
7323C	-	Hospital Frame - M	Handgrip height: 765mm - 840mm (30" - 33"). Max width: 660mm (25"). Max depth: 585mm (23"). Product weight: 1.9kg. Ferrule: Z25.	160kg (25st)
7325C	-	Hospital Frame - L	Handgrip height: 865mm - 940mm (34" - 37"). Max width: 660mm (25"). Max depth: 585mm (23"). Product weight: 1.9kg. Ferrule: Z25.	
7333C	-	Hospital Frame - M with wheels	Handgrip height: 780mm - 864mm (31" - 34"). Max width: 660mm (25"). Max depth: 585mm (23"). Product weight: 2.0kg. Ferrule: Z25.	
7335C	-	Hospital Frame - L with wheels	Handgrip height: 885mm - 965mm (35" - 38"). Max width: 660mm (25"). Max depth: 585mm (23"). Product weight: 2.0kg. Ferrule: Z25.	



Ultra-Narrow Walking Frame

Designed for users with disabilities or those who have difficulty with walking but are capable of walking by themselves with a little support. A narrow frame style helps manoeuvre in smaller spaces.

- Coopers walking frames are made from high tensile seam welded aluminium, making them both lightweight and very strong
- Specially profiled hand grips ensure user safety and comfort
- The ultra-narrow frame is ideal for domestic use or where space is limited
- Height adjustable, available with or without wheels

Coopers Product Code	TCES Code Number	Coopers Product Name	Technical Specification	Max User Weight
7344C	M018	Ultra-narrow Frame - M	Handgrip height: 755mm - 840mm (30"-33"). Max width: 490mm (19½"). Max depth: 450mm (17½"). Product weight: 1.75kg. Ferrule: Z25.	160kg (25st)
7345C	M028	Ultra-narrow Frame - L	Handgrip height: 840mm - 915mm (33"-36"). Max width: 490mm (19½"). Max depth: 450mm (17½"). Product weight: 1.75kg. Ferrule: Z25.	
7346C	-	Ultra-narrow Frame - M with wheels	Handgrip height: 775mm - 864mm (31"-34"). Max width: 490mm (19½"). Max depth: 450mm (17½"). Product weight: 1.80kg. Ferrule: Z25.	
7347C	-	Ultra-narrow Frame - L with wheels	Handgrip height: 860mm - 940mm (34"-37"). Max width: 490mm (19½"). Max depth: 450mm (17½"). Product weight: 1.80kg. Ferrule: Z25.	



Forearm Walking Frame with Castors

A lightweight aluminium walking frame designed to give support when walking.

A walking frame fitted with forearm troughs and 3" swivelling front castors
Manufactured from aluminium, the frame is lightweight but strong and rigid enough to give

Coopers Product Code	TCES Code Number	Coopers Product Name	Technical Specification	Max User Weight
7255C	M008	Forearm Frame with Castors	Trough height: 990mm - 1118mm (35½" - 44"). Max width: 670mm (26"). Max depth: 565mm (22"). Product weight: 4.6kg. Ferrule: Z25	127kg (20st)



Domestic Walking Frame

A strong yet lightweight walking frame that is height adjustable. This walking frame is ideal for those who need support when walking.

- Designed for indoor use
- Made from high tensile seam welded aluminium making them both lightweight and very strong
- Specially profiled hand grips ensure user safety and comfort
- These height adjustable frames are available in three size options
- Available with or without wheels

Coopers Product Code	TCES Code Number	Coopers Product Name	Technical Specification	Max User Weight
7321C	M009	Domestic Frame - S	Handgrip height: 665mm - 740mm (26" - 29"). Max width: 560mm (22"). Max depth: 520mm (20½"). Product weight: 1.9kg. Ferrule: Z25.	160kg (25st)
7341C	M010	Domestic Frame - M	Handgrip height: 765mm - 840mm (30" - 33"). Max width: 560mm (22"). Max depth: 520mm (20½"). Product weight: 1.9kg. Ferrule: Z25.	
7343C	M011	Domestic Frame - L	Handgrip height: 865mm - 940mm (34" - 37"). Max width: 560mm (22"). Max depth: 520mm (20½"). Product weight: 1.9kg. Ferrule: Z25.	
7331C	M003	Domestic Frame - S with wheels	Handgrip height: 695mm - 762mm (27" - 30"). Max width: 560mm (22"). Max depth: 520mm (20½"). Product weight: 2.0kg. Ferrule: Z25.	
7351C	M004	Domestic Frame - M with wheels	Handgrip height: 780mm - 864mm (31" - 34"). Max width: 560mm (22"). Max depth: 520mm (20½"). Product weight: 2.0kg. Ferrule: Z25.	
7353C	M005	Domestic Frame - L with wheels	Handgrip height: 885mm - 966mm (35" - 38"). Max width: 560mm (22"). Max depth: 520mm (20½"). Product weight: 2.0kg. Ferrule: Z25.	

Movility

Walkers Wheels



Walking Frame Wheels

Designed to replace the height adjustable foot of a walking frame, converting the frame to a wheeled walker.

Coopers Product Code	TCES Code Number	Coopers Product Name	Technical Specification	Max User Weight
7253C	M022	Walking Frame Wheels	Wheel diameter: 125mm (5")	-

Wheels for Child's Walker

A pair of wheels for the child's folding walker.

Coopers Product Code	TCES Code Number	Coopers Product Name	Technical Specification	Max User Weight
7254C	-	Wheels for Child's Walker	Wheel diameter: 76mm (3"). Tube diameter: 22mm (0.875").	-

Lightweight Rolling Walker

This lightweight aluminium rolling walker has rugged 8" wheels for outdoor use.

- Height adjustable
- Deluxe padded seat and straight backrest for enhanced support
- Features easy to use loop brakes
- Folds for storage
- Comes complete with seat and basket
- Colour - blue
- Available in a cost saving multipack. See page 29

Coopers Product Code	TCES Code Number	Coopers Product Name	Technical Specification	Max User Weight
10910C	-	Lightweight Rolling Walker	Handle height: 780mm - 915mm (30¾" - 36"). Seat height: 510mm (20"). Maximum width: 620mm (24½"). Seat width: 340mm x 340mm (13½" x 13½"). Depth (folded, with backrest): 470mm (18½"). Product weight: 9.3kg	125kg (19st)



Walkers & Rollators



Foldable Rollator with tray and basket

Code. A522

Steel folding rollator with 4 wheels of 200 mm, tray and basket. Suitable for indoor and outdoor.

Seat 39 x 22 cm. Color: Anthracite gray.

Adjustable height	79 a 94 cm
Seat height	61 cm
Front width	45,5 cm
Rear width	58 cm
Length	70 cm
Max user weight	120 kg
Max load basket	5 kg



3 folding wheels Rollator

Code. A523

Folding steel wheels rollator of 200 mm wheels. Adjustable in height. Suitable for indoor and outdoor use. Anthracite gray.

Adjustable height	77 a 89 cm
Max width	64 cm
Length	62 cm
Max user weight	100 kg

Movility

Walkers & Rollators

Heavy Duty Rolling Walker

Wider than our standard rolling walkers, this heavy duty rolling walker offers additional support and comfort for the larger user.

- Height adjustable aluminium frame
- Deluxe padded seat and back rest
- 8" wheels for outdoor use
- Easy to use loop brakes

Coopers Product Code	TCES Code Number	Coopers Product Name	Technical Specification	Max User Weight
10929C	-	Heavy Duty Rolling Walker	Handle height: 890mm - 990mm (35" - 39"). Seat height: 560mm (22"). Maximum width: 735mm (29). Width between handles: 545mm (21½"). Seat width: 460mm x 350mm (18½" x 14"). Depth: (folded, with backrest) 500mm (19¾"). Product weight: 11.85kg	180kg (28st)



Extra Heavy Duty Rolling Walker

This rolling walker features an extra-wide design and durable construction for comfort and stability.

- Height adjustable
- A deluxe padded seat and backrest provide enhanced support
- Comes with 8" wheels which are ideal for outdoor use
- Easy to use loop brakes
- Comes complete with seat and basket

Coopers Product Code	TCES Code Number	Coopers Product Name	Technical Specification	Max User Weight
10931C	-	Extra Heavy Duty Rolling Walker	Handle height: 890mm - 980mm (35" - 39"). Seat height: 560mm (22"). Maximum width: 760mm (31"). Width between handles: 600mm (24"). Seat width: 460mm x 350mm (18½" x 14"). Depth: (folded, with backrest) 500mm (19¾"). Product weight: 12.8kg	227kg (35st)



Movility

Crutches and sticks



Aluminum crutch

Code. 120A /121A

Aluminum crutch, resistant and light.
Adjustable on the lower and upper part (Code. 121A)
Also available only with adjustable lower part (Code. 120A)
Optional pack of handles in 3 colors: red, blue and green

Upper part regulation (elbow - forearm)	19 to 23 cm
Lower part regulation (floor - elbow)	69.6 to 95 cm
Maximum user weight	100 kg



Integral elbow crutch

Code.130

Full length aluminum crutch. Great lightness and resistance
Its ergonomic design provides a good grip, and an ideal distribution of pressure, avoiding pain and marks on the hand.
Gray

Height of adjustable handle	70 a 95 cm
Max user weight	100 Kg



Aluminium crutch with articulated elbow

Code. 123A/ 128A

Aluminum crutch with articulated elbow.
Adjustable on top and bottom (Code. 128A)
Also available only with adjustable lower part (Code. 123A)
Optional pack of handles in 3 colors: red, blue and green

Upper part regulation (elbow - forearm)	19 to 23 cm
Lower part regulation (floor - elbow)	69.6 to 95 cm
Maximum user weight	100 kg



Folding anodized aluminum crutch

Code. 642

It folds and unfolds easily.
Adjustable in height from 81 to 92 cm.

Total height	81 a 92 cm
Max user weight	114 Kg



Child crutch

Code. 125

Aluminum children's crutch, very resistant and lightweight
Adjustable at the bottom

Regulación en altura	62 a 82 cm
Peso máximo de usuario	50 kg



Aluminum underarm crutch

Code. A611

Aluminum crutch with rubber foam support in the underarm support
Adjustable cuff in different heights

Adjustable height	118,5 a 139 cm
Max user weight	120 Kg

Movility

Crutches and sticks



Permanent User Crutch

This extra-strong crutch made from reinforced aluminium is designed for those users with longer term needs.

- The absence of adjustment holes makes the crutch 'silent' in use
- The crutch is supplied in one standard length and may be cut to the required length
- Choice of PVC handle or comfy handle
- Latex free (including ferrules)

190kg
(30st)



Coopers Product Code	TCES Code Number	Coopers Product Name	Technical Specification	Max User Weight
8047C	-	Permanent User Crutch - PVC handle, standard ferrules	Handle to Floor (excluding ferrule): 960mm (38"). Top of cuff to handle: 229mm (9"). Cuff diameter: 100mm (4"). Product weight: 800g each. Standard ferrule: Z25. Sold as a pair.	190kg (30st)
8041C	-	Permanent User Crutch - COMFY handle, standard ferrules		



Arthritic Elbow Crutch

For arthritics or those with impaired grip.

- Adjustable height
- A padded forearm trough distributes the user's weight over a large support area
- The adjustable telescopic handle rotates through 360° and locks to suit individual forearm length
- Latex free including ferrules
- Available in a cost saving multipack. See page 29

Coopers Product Code	TCES Code Number	Coopers Product Name	Technical Specification	Max User Weight
8300C	-	Arthritic Elbow Crutch	Trough height: 980mm - 1219mm (38" - 48"). Product weight: 950g each. Ferrule: Z25. Sold as a pair.	127kg (20st)

Elbow Crutch - Soft Touch (PVC Handle)

Lightweight, high strength single and double adjustable crutches, both fitted with soft PVC handles for added comfort.



- Height adjustable
- Cuff height adjustment in the double adjustable crutches
- Soft touch comfortable handle
- Latex free (including ferrules)
- 160kg (25 stone) max user weight
- Available in a cost saving multipack. See page 29



160kg
(25st)

Coopers Product Code	TCES Code Number	Coopers Product Name	Technical Specification	Max User Weight
8303C	-	Single adjustable - adult. Handgrip height: 670mm - 940mm (26" - 37"). Cuff to handgrip: 240mm (9").	Cuff diameter: 95mm (3 3/4"). Product weight: 600g each. Ferrule: Z22. Sold as a pair.	160kg (25st)
8249C	-	Double adjustable - small. Handgrip height: 440mm - 685mm (17" - 27"). Cuff to handgrip: 165mm - 215mm (7" - 9").		
8251C	-	Double adjustable - medium. Handgrip height: 530mm - 806mm (21" - 32"). Cuff to handgrip: 200mm - 275mm (8" - 11").		
8253C	-	Double adjustable - adult. Handgrip height: 635mm - 960mm (25" - 38"). Cuff to handgrip: 220mm - 295mm (9" - 12").		
9731C	-	Double adjustable - extra long. Handgrip height: 820mm - 1092mm (32" - 43"). Cuff to handgrip: 220mm - 295mm (9" - 12").		



Movility

Crutches and sticks

Tetrapods and Tripods

Helping to increase stability and balance whilst walking and standing, this walking stick provides additional stability compared to a normal walking stick.

- The centre of the handle is barrel shaped to fit the palm
- The front of the handle tapers to accommodate the fingers and encourage the user to point the index finger along the stem, and then flares at the end to prevent slipping
- Height adjustable
- Available in a cost saving multipack. See page 29

TETRAPOD (SMALL BASE)				
Coopers Product Code	TCES Code Number	Coopers Product Name	Technical Specification	Max User Weight
7808C	M016	Tetrapod (small base)	Height adjustment: 720mm - 965mm (28" - 38"). Product weight: 1kg. Ferrule: Z16	127kg (20st)

TETRAPOD (LARGE BASE)				
Coopers Product Code	TCES Code Number	Coopers Product Name	Technical Specification	Max User Weight
7810C	-	Tetrapod (large base)	Height adjustment: 765mm - 1016mm (30" - 40"). Product weight: 1kg. Ferrule: Z16	127kg (20st)

TETRAPOD (CENTRED LEGS)				
Coopers Product Code	TCES Code Number	Coopers Product Name	Technical Specification	Max User Weight
7812C	-	Tetrapod (centred legs)	Height adjustment: 720mm - 965mm (28" - 38"). Product weight: 1kg. Ferrule: Z16	127kg (20st)

TRIPOD				
Coopers Product Code	TCES Code Number	Coopers Product Name	Technical Specification	Max User Weight
7782C	M015	Tripod	Height adjustment: 765mm - 1016mm (30" - 40"). Product weight: 1kg. Ferrule: Z16	127kg (20st)

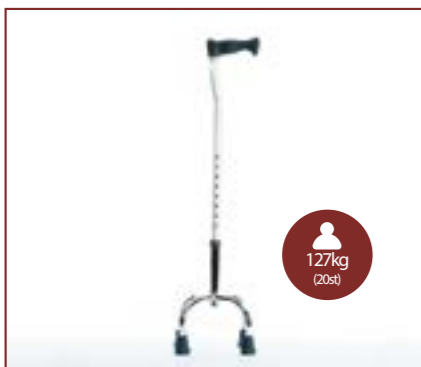

Straight Neck Aluminium Support Stick

Helps increase stability and balance while walking and standing.

- A strong, lightweight support stick which is height adjustable
- Manufactured from aluminium
- Plastic handle
- Available in a cost saving multipack. See page 29

Coopers Product Code	TCES Code Number	Coopers Product Name	Technical Specification	Max User Weight
7704C	-	Straight Neck Support Stick - Plastic Handle	Adjustable length: 700mm - 960mm (27½" - 38"). Product weight: 450g. Ferrule: Z22.	127kg (20st)
7706C	MO13	Straight Neck Support Stick - Plastic Handle	Adjustable length: 845mm - 1090mm (33" - 43"). Product weight: 450g. Ferrule: Z22.	



Swan Neck Aluminium Support Stick

- A strong, lightweight support stick which is height adjustable
- The swan neck helps to transmit the weight of the user vertically through the body of the stick
- Manufactured from aluminium
- PVC handle
- Available in a cost saving multipack. See page 29

Coopers Product Code	TCES Code Number	Coopers Product Name	Technical Specification	Max User Weight
7711C	-	Swan Neck PVC Handle	Adjustable length: 710mm - 965mm (28" - 38"). Product weight: 550g. Ferrule: Z22.	127kg (20st)
7713C	-	Swan Neck PVC Handle	Adjustable length: 840mm - 1092mm (33" - 43"). Product weight: 550g. Ferrule: Z22.	



Straight Neck Aluminium Support Stick

Lightweight, high strength support stick.

- A strong, lightweight support stick which is height adjustable
- Also available with a white shaft for the visually impaired
- Manufactured from aluminium
- PVC handle
- Available in a cost saving multipack. See page 29

Coopers Product Code	TCES Code Number	Coopers Product Name	Technical Specification	Max User Weight
7701C	-	Straight Neck PVC Handle	Adjustable length: 710mm - 965mm (28" - 38"). Product weight: 550g. Ferrule: Z22.	127kg (20st)
7703C	-	Straight Neck PVC Handle	Adjustable length: 840mm - 1092mm (33" - 43"). Product weight: 550g. Ferrule: Z22.	
5652C	SAV08	Straight Neck PVC Handle with white shaft	Adjustable length: 840mm - 965mm (33" - 38"). Product weight: 550g. Ferrule: Z22.	

Movility

Crutches and sticks

Adjustable Fischer Stick

The unique Fischer handle is biometrically shaped to spread pressure evenly across the palm of the hand. Useful for arthritics and others who have difficulty gripping.

- Fischer handle mounted on a high strength aluminium shaft
- Height adjustable

ANODISED ALUMINIUM STICK				
Coopers Product Code	TCES Code Number	Coopers Product Name	Technical Specification	Max User Weight
7728C	-	Fischer Stick - Medium (right hand)	Height adjustment: 670mm - 940mm (27" - 37"). Product weight: 400g. Ferrule: D18.	127kg (20st)
7727C	-	Fischer Stick - Medium (left hand)	Height adjustment: 670mm - 940mm (27" - 37"). Product weight: 400g. Ferrule: D18.	
7726C	M014R	Fischer Stick - Adult (right hand)	Height adjustment: 815mm - 1067mm (32" - 42"). Product weight: 400g. Ferrule: D18.	
7725C	M014L	Fischer Stick - Adult (left hand)	Height adjustment: 815mm - 1067mm (32" - 42"). Product weight: 400g. Ferrule: D18.	

BLACK STICK				
Coopers Product Code	TCES Code Number	Coopers Product Name	Technical Specification	Max User Weight
7657C	-	Fischer Stick - Adult (right hand)	Height adjustment: 670mm - 940mm (27" - 37"). Product weight: 400g. Ferrule: D18.	127kg (20st)
7655C	-	Fischer Stick - Adult (left hand)	Height adjustment: 670mm - 940mm (27" - 37"). Product weight: 400g. Ferrule: D18.	



Aluminium Support Sticks - Fischer Stick



Black Support Sticks - Fischer Stick

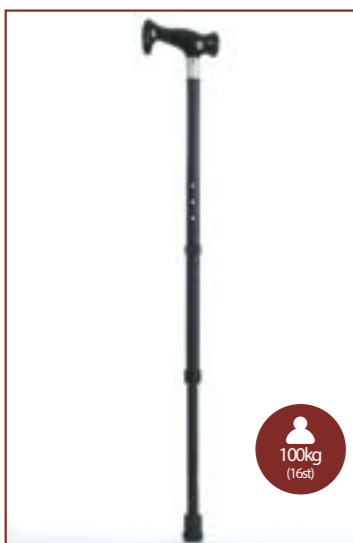

Escort Handle Cane

- Height adjustable aluminium support stick with escort handle
- Supplied with horseshoe clips for quick and easy height adjustment
- Available in a cost saving multipack. See page 29

Coopers Product Code	TCES Code Number	Coopers Product Name	Technical Specification	Max User Weight
7653C	-	Escort Handle Cane	Length: 700mm - 940mm (27½" - 37"). Product weight: 365g. Ferrule: D18.	100kg (16st)



Hospital Walking Stick

Handmade from the best selected chestnut, sealed and finished in a light brown colour.

- The crook is formed in Coopers' unique 'D' shape, which allows the fingers more room, spreading the pressure and giving greater comfort and stability
- Available in cost saving multipacks. See page 29

STANDARD WALKING STICKS				
Coopers Product Code	TCES Code Number	Coopers Product Name	Technical Specification	Max User Weight
7561	-	Chestnut Walking Stick 915mm (36") without Ferrule	Product weight 300g	127kg (20st)
7562	-	Chestnut Walking Stick 965mm (38") without Ferrule		
7563	-	Chestnut Walking Stick 1016mm (40") without Ferrule		
7564	-	Chestnut Walking Stick 1067mm (42") without Ferrule		
7530	-	Chestnut Walking Stick 915mm (36") with D19 Ferrule		
7531	MO27	Chestnut Walking Stick 965mm (38") with D19 Ferrule		
7532	-	Chestnut Walking Stick 1016mm (40") with D19 Ferrule		
7533	-	Chestnut Walking Stick 1067mm (42") with D19 Ferrule		
7591	-	Chestnut Walking Stick 915mm (36") with Z18 Ferrule		
7592	-	Chestnut Walking stick 965mm (38") with Z18 Ferrule		
7593	-	Chestnut Walking Stick 1016mm (40") with Z18 Ferrule		
7594	-	Chestnut walking stick 1067mm (42") with Z18 Ferrule		



EXTRA STRONG WALKING STICKS				
Coopers Product Code	TCES Code Number	Coopers Product Name	Technical Specification	Max User Weight
7572	-	Chestnut Walking Stick 965mm (38") without Ferrule	Product weight 400g	127kg (20st)
7573	-	Chestnut Walking Stick 1016mm (40") without Ferrule		
7574	-	Chestnut Walking Stick 1067mm (42") without Ferrule		
7540	-	Chestnut Walking Stick 915mm (36") with D22 Ferrule		
7541	-	Chestnut Walking Stick 965mm (38") with D22 Ferrule		
7542	-	Chestnut Walking Stick 1016mm (40") with D22 Ferrule		
7543	-	Chestnut Walking Stick 1067mm (42") with D22 Ferrule		

Movility

Crutches and sticks



Type D Ferrule

Ferrules marked * are latex free.

Coopers Product Code	TCES Code Number	Coopers Product Name	Technical Specification	Max User Weight
9755	-	Type D Ferrule 18mm	-	-
9756C*	M002	Type D Ferrule 19mm	-	-
9757	-	Type D Ferrule 22mm	-	-
9776C*	-	Type D Ferrule 30mm	-	-



Type Z Ferrule

Latex free.

Coopers Product Code	TCES Code Number	Coopers Product Name	Technical Specification	Max User Weight
9768C	-	Type Z Ferrule 16mm	-	-
9764C	-	Type Z Ferrule 18mm	-	-
9766C	-	Type Z Ferrule 22mm	-	-
9767C	-	Type Z Ferrule 25mm	-	-
9769C	-	Type Z Ferrule 30mm	-	-

Toileting

Stacking Commode



Toilet chair with wheels

Code. A3004

Steel toilet chair with 130 mm wheels (2 of them with brake).
Folding armrests and removable backrest.

Backrest	43,5 x 20 cm	Total height	98,5 cm
Seat	44 x 41,5 cm	Seat height	53 cm
Width	54,5 cm	Seat-armrest distance	20 cm
Length	88 cm	Max user weight	100 kg



Toilet chair

Code. A2006

Steel toilet chair painted in light gray color. With folding armrests
Seat: 35 x 41 cm

Seat height to the ground	43 a 55,5 cm
Height of armrests	27 cm
Distance between armrests	45 cm
Max user weight	100 kg



Toilet chair

Code. A3005

Steel toilet chair with seat provided with cushion and toilet bowl with lid.
Backrest: 46 x 37.5 cm
Seat: 44 x 40.5 cm

Width	60 cm	Seat height without cushion	42 cm
Length	51 cm	Seat height with cushion	45,5 cm
Height	84 cm	Max user weight	120 kg

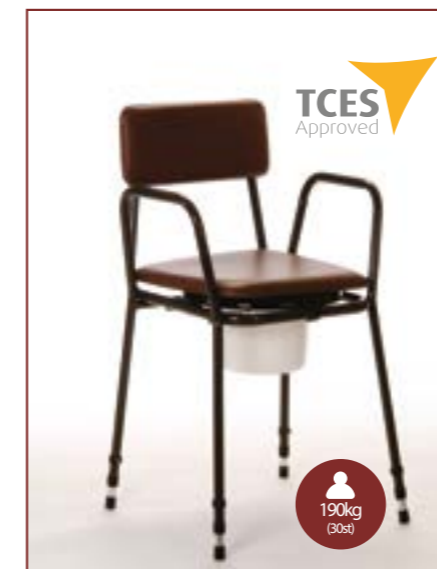

An adjustable height, free standing commode with attached toilet seat and removable commode pan.

- Made from high quality steel with tough powder coating
- Available as either fixed or adjustable height
- Cushioned seat and back covered in flame retardant vinyl
- Commode pan and lid included
- Available in a cost saving multipack. See page 29

Coopers Product Code	TCES Code Number	Coopers Product Name	Technical Specification	Max User Weight
10402C	TA06	Stacking Commode - adjustable height	Adjustable seat height: (excluding cushion) 480mm - 580mm (19" - 23").	190kg (30st)
10400C		Stacking Commode - fixed height	Fixed seat height (excluding cushion): 490mm (19½"). Width between arms: 480mm (19")	
10408C	Spare Commode Pan	Seat: 410mm x 410mm (16" x 16"). Product weight: 6.5kg.		



Aluminum toilet chair

Code. A2002

Aluminum toilet chair. Adjustable in height.
Gray.
Seat: 35 x 41,5 cm

Width	53 cm	Seat height to the ground	38 a 48 cm
Length	42 cm	Distance between the armsests	44 cm
Height	72 a 82,5 cm	Max user weight	100 kg

Toileting

Stacking Commode



Bath chair with padded seat

Code. A2003

Aluminum bath chair with padded seat.
100 mm wheels, the 2 rear ones with brake.

Backrest	53 x 30 cm	Total height	99 cm
Seat	41 x 41 cm	Seat height	57 cm
Width	56 cm	Floor-armrest distance	74 cm
Length	62 cm	Max user weight	100 kg



Self-propelled bad chair

Code. A538

Self-propelled aluminum bath chair. It can be used as shower chair, toilet chair and indoor chair.

With plastic forks and wheels to avoid corrosion

Backrest	43 x 23 cm	Total height	100,5 - 108 cm
Seat	43 x 40 cm	Seat height	54,5 - 62 cm
Width	62,5 cm	Floor-armrest distance	22 cm
Length	103 cm	Max user weight	120 kg



Bathroom chair with small wheels

Code. A539

Aluminum bath chair with small wheels. It can be used as shower chair, toilet chair and indoor chair. Due to its small dimensions, it is ideal for narrow spaces. With plastic forks and wheels, to avoid corrosion.

Backrest	43 x 23 cm	Total height	99,5 - 109 cm
Seat	43 x 40 cm	Seat height	54,5 - 64 cm
Width	55 cm	Floor-armrest distance	22 cm
Length	98 cm	Max user weight	120 kg



Toileting Urinals

Fracture Pan Urinal

This large slipper style pan has a smooth surface to allow it to be easily moved under the body's shape

- Suitable for disinfection in an autoclave to 135°C
- Biocote protected
- Available in a cost saving multipack. See page 29

Coopers Product Code	TCES Code Number	Coopers Product Name	Technical Specification	Max User Weight
10849	-	Fracture Pan Urinal	Capacity: 1 litre. Size: 449mm x 309mm x 99mm (17 3/4" x 12" x 4").	-
10849MP	-	Fracture Pan Urinal (carton of 12)		



Female Urinal

A clear plastic bottle anatomically designed specifically for women to allow hygienic use.

- Graduations for easy measuring
- Can be used whilst sitting, standing or in bed
- Biocote protected
- Available in a cost saving multipack. See page 29

Coopers Product Code	TCES Code Number	Coopers Product Name	Technical Specification
10846	TA08	Female Urinal	
10846MP		Female Urinal (carton of 20)	Capacity 1 litre



Male Urinal

A clear plastic bottle anatomically designed specifically for men to allow hygienic use.

- Graduations for easy measuring
- Snap-on cap
- Suitable for disinfection in an autoclave to 135°C
- Biocote protected
- Available in a cost saving multipack. See page 29

Coopers Product Code	TCES Code Number	Coopers Product Name	Technical Specification
10845	-	Male Urinal	
10845MP	-	Male Urinal (carton of 25)	Capacity 1 litre



Code. A903

Sanitary bedpan



Code. A105

Male urinal

Bathroom

Shower Chairs & boards



Shower bench with backrest

Code. A1004

Shower bench with backrest, white color. Lightweight, anodized aluminum.

Anti-skid tips for greater safety on wet surfaces.

Backrest: 51 x 31 cm (width x height)

Seat: 51 x 31 cm (width x depth)

Technical specifications

Width	51 cm
Seat height	35 a 53 cm
Length	43 cm
Max user weight	114 kg



Prima Bath Step

With a large flat surface area and built in non-slip pads, this bath step is safe and secure in use. It has been designed in modular components, allowing the step height to be altered if necessary.

- The set comprises a 50mm (2") step, plus two 25mm (1") risers, four non-slip feet and a link to allow two steps to be fixed together side by side
- The bath steps modular nature gives a nominal height of 50mm (2") to 97mm (nearly 4")
- May be assembled up to 300mm (12") high by purchasing additional 25mm (1") risers
- Available in a cost saving multipack. See page 29

Coopers Product Code	TCES Code Number	Coopers Product Name	Technical Specification	Max User Weight
62920	-	Prima Bath Step	Surface area: 445mm x 350mm (17½" - 13½")	240kg (38st)
61921	-	Riser for Prima Bath Step	Height: 25mm (1")	-



Shower bench

Code. A1003

White shower bench. Lightweight, anodized aluminum.

Anti-skid tips for greater safety on wet surfaces.

Seat: 51 x 31 cm (width x depth)

Technical specifications

Width	44 cm
Seat height	34 a 53 cm
Length	44 cm
Max user weight	114 kg

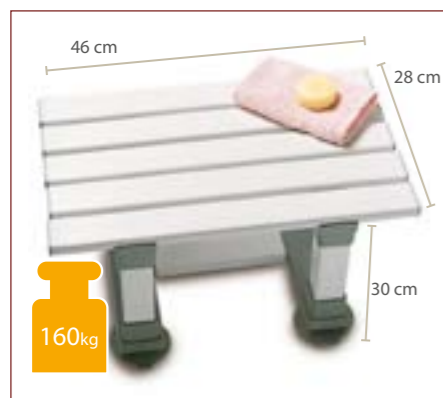

Bath / shower bench

Code. 10159

PVC bath / shower bench, very resistant.

It is conveniently fixed by a system of suction cups.

Technical specifications

Height	30 cm
Width	46 cm
Depth	28 cm
Max user weight	160 kg



Merlin Bathboard

When fitted across the bath, this bathboard provides a seated platform area to assist those who are unable to get in and sit down in the normal way. It can also be used as a seat to allow over bath showering. It enables the user to get into and out of the bath with greater ease and comfort.

- Made of highly durable reinforced PVC
- Compatible with plastic, steel and cast iron baths
- Features tapered slats to encourage rapid drainage
- The self locating fixing system ensures secure positioning
- An optional handle code 10176C is available offering additional user confidence
- Available in a cost saving multipack. See page 29

Coopers Product Code	TCES Code Number	Coopers Product Name	Technical Specification	Max User Weight
10164C	BA01	Merlin Bathboard 660mm (26")	Width: 228mm (9"). Product weight: 2.2kg.	190kg (30st)
10165C	BA02	Merlin Bathboard 686mm (27")		
10166C	BA03	Merlin Bathboard 711mm (28")		
10176C	-	Optional Handle	-	-

Bathroom

Bathboards and bathseats

Merlin Showerboard

Wider than our standard bathboard, this six slat board provides a comfortable seated platform area to assist those unable to step in and sit down in the usual way. It can also act as a seat to allow over-bath showering.

- Six tapered slats to encourage rapid water drainage
- Constructed of reinforced PVC for maximum durability
- Secured into position with Coopers' unique self locating fixing system
- An optional handle code 10176C is available offering additional user confidence
- Available in a cost saving multipack. See page 29



Coopers Product Code	TCES Code Number	Coopers Product Name	Technical Specification	Max User Weight
10167C	BA04	Merlin Showerboard 660mm (26")	Width: 340mm (13½"). Product weight: 3.2kg.	190kg (30st)
10169C	BA05	Merlin Showerboard 686mm (27")		
10168C	BA06	Merlin Showerboard 711mm (28")		
10176C	-	Optional Handle		



Wall seat for shower

Code. A558

Wall seat for the shower, with anatomical shape, folding and resistant to corrosion.

Technical specifications

Height	40,5 a 56 cm
Seat width	49,5 cm
Seat depth	30,5 cm
Max user wieght	100 kg



Swivel bathtub seat

Code. A568

Swivel bath seat, to facilitate the entry and exit of the bath.

With safety locking device with three positions: 90° to the left, center, and 90° to the right.

Technical specifications

Backrest height	38 cm
Seat width	40 cm
Legs dimensions	53 x 71 cm
Max user weight	115 kg



Head wash tray ref

Code. A567

Portable tray to wash the head. Designed for domestic or sanitary use.

Can be used on the wheelchair itself, or on any other chair

Its adaptable shape to the neck and its adjustment of height and inclination allows to wash the head comfortably both children and adults or the elderly.

It is sold in boxes of 3 units.

Bedroom Aids

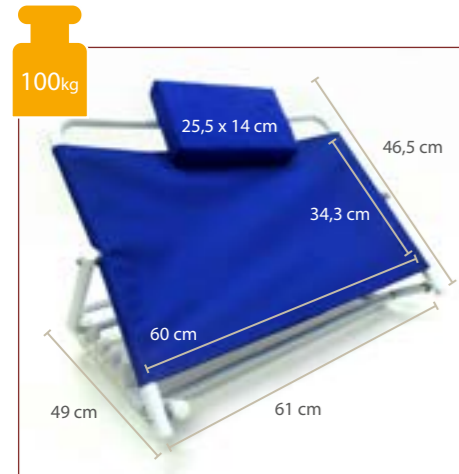

Back incorporator

Code. A534

It allows the patient to be raised to a sitting position to facilitate reading, eating, etc. actions.
With headrest pad, for comfort.

Total width	61 cm	Total height	46,5 cm
Base length	49 cm	Headrest dimensions	25,5 x 14 cm
Upholstery dimensions	60x 34,3 cm	Max user weight	100 kg



Dropper support

Code. A160

Dropper support in chromed steel, adjustable in height

Technical specifications

Adjustable height	115 a 207 cm
Base-floor height	7 cm



Tilting bed table

Code. A535

Tilting bed table up to 90° in both directions.
With large tray and a large surface.

Technical specifications

Table width	60 cm
Table depth	40 cm
Total height	70 a 117 cm

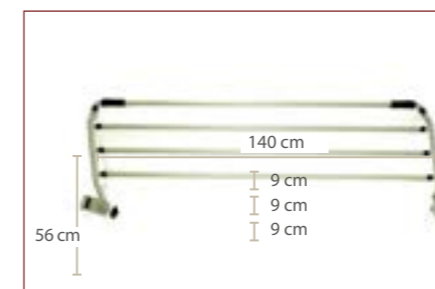

Folding handrails

Code. A4005

Steel bed railing. It folds very easily resulting in a smooth surface to move or care for the patient with total comfort.
Valid for all types of bed bases
This product complies with standard EN60601-2-52 regarding fatigue, overturning and entrapment.

Technical specifications

Handrail length	140 cm
Total height	56 cm
For mattress dimensions	Max 7cm height x 3 cm width



Pedalier

Code. A3001

Pedalier made of chromed steel to exercise the upper and lower limbs.
It allows to easily regulate the effort to be made.

Technical specifications

Length	50 cm
Width	40,5 cm
Height	23 cm
Pedal length	10 cm

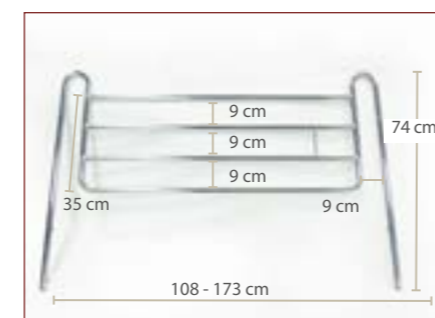

Sliding handrails

Code. A4002

Sliding handrails in chromed steel. Valid for all types of bed bases
This product complies with standard EN60601-2-52 regarding fatigue, overturning and entrapment.

Technical specifications

Longitud	108 a 173 cm
Altura total	74 cm



Households

Skin protection mattresses

Anti-decubitus mattress with alternating cells

Code. A1140H

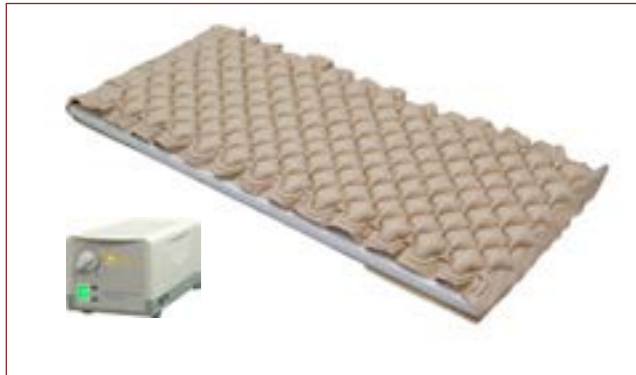

NOTE: Patches to repair included

The system of alternating cells allows a homogeneous distribution of pressure in decubitus, minimizing pressure peaks and protecting areas at risk of developing pressure ulcers.
Compressor with manual pressure regulation, from 40 to 100 mmHg. PVC mattress composed of 130 air cells, with skirts for a better fixation to the mattress of the bed.
It is placed on top of the mattress of the bed (it does not replace it)
Light and easy to transport. It swells completely in 20 minutes
Compressor specifications

Dimensions	22.4 cm x 10.8 cm x 10.3 cm		
Air exit	> 4.5 liters/min.	Consumption	5 W
Cycle	10 min	Sound	30 - 40 decibels
Weight	1,4 kg	Pressure	40 a 100 mmHg

Mattress specifications

Dimensions	280 x 90 cm x 6,5 cm
Max user weight	100 kg

Anti-decubitus mattress with alternating cells

Code. A8000H



NOTE: No additional mattress required

The system of alternating cells allows a homogeneous distribution of pressure in decubitus, minimizing pressure peaks and protecting risk areas triggering pressure ulcers.
Compressor with digital control to regulate cycle time and pressure automatically.
Mattress composed of 20 air cells + base
The 2 cells of the head do not deflate (pillow effect).
Water-resistant and breathable nylon case that reduces friction
Allows you to select Alternating or Static mode.
Indicator / Alarm of low pressure

Compressor specifications

Dimensions	28 cm x 20 cm x 12 cm		
Air exit	8-9 litros/min.	Sound	30 - 40 decibels
Cycle	10/15/20/25 min	Pressure	20 a 70 mmHg
Weight	2,5 kg		

Especificaciones del colchón

Dimensions	203 x 88 cm x 20 cm
Max user weight	180 kg

Anti-decubitus mattress with alternating cells

Code. A5000H



NOTE: No additional mattress required

The system of alternating cells allows a homogeneous distribution of pressure in decubitus, minimizing pressure peaks and protecting risk areas triggering pressure ulcers.
Compressor with manual pressure regulation, from 40 to 100 mmHg
Mattress composed of 18 air cells and 5 cm foam base
The 2 cells of the head do not deflate (pillow effect)
Allows you to select Alternating or Static mode
Water-resistant and breathable nylon case that reduces friction
Indicator / Alarm of low pressure

Compressor specifications

Dimensions	28 cm x 20 cm x 12 cm		
Air exit	8-9 liters/min.	Sound	30 - 40 decibelios
Cycle	12 min	Pressure	40 a 100 mmHg
Weight	2,2 kg		

Mattress specifications

Dimensions	200 x 90 cm x 17,5 cm
Max user weight	160 kg

Households

Stocking and Sock Aid

Aids the users to put on socks, stockings or tights easily without the need to bend down. Simply roll the sock, stocking or tights onto the aid, slip in your foot, then use the straps to pull the clothing item up the leg.

- Available in a cost saving multipack. See page 29

Coopers Product Code	TCES Code Number	Coopers Product Name	Technical Specification	Max User Weight
10624	PL05	Stocking and Sock Aid	-	-



Long Handle Shoe Horn

A long handled shoe horn to aid the user to reach and put on shoes easily.

Coopers Product Code	TCES Code Number	Coopers Product Name	Technical Specification	Max User Weight
10626	PL04	Long Handle Shoe Horn	Length: 530mm (21")	-



Classic Reacher

An easy to use aid which helps the user to pick up items without bending or crouching.

- Lightweight and easy to use with an improved comfort handle
- The Classic Reacher makes an ideal dressing aid
- The Gripcert rubber is kind and gentle to skin
- Comes with a handy stick clip attachment and magnet on the end to help pick up metal items, such as keys etc
- Lifetime warranty
- Available in a cost saving multipack. See page 29

Coopers Product Code	TCES Code Number	Coopers Product Name	Technical Specification	Max User Weight
10650	PL01	Classic Reacher 660mm (26")	-	-
10652	PL19	Classic Reacher 830mm (32")	-	-





Our products are in constant process of improvement, so Sunrise Medical reserves the right to change the design of the same and the specified specifications without prior notice.



Sunrise Medical GmbH

Kahlbachring 2-4

69254 Malsch / HD

Germany

Phone: +(49) (0) 7253 980 0

Fax: +(49) (0) 7253 980 222

Email: international@sunrisemedical.de

www.sunrisemedical.eu