

MONTERINGSANVISNING

Vadplatta

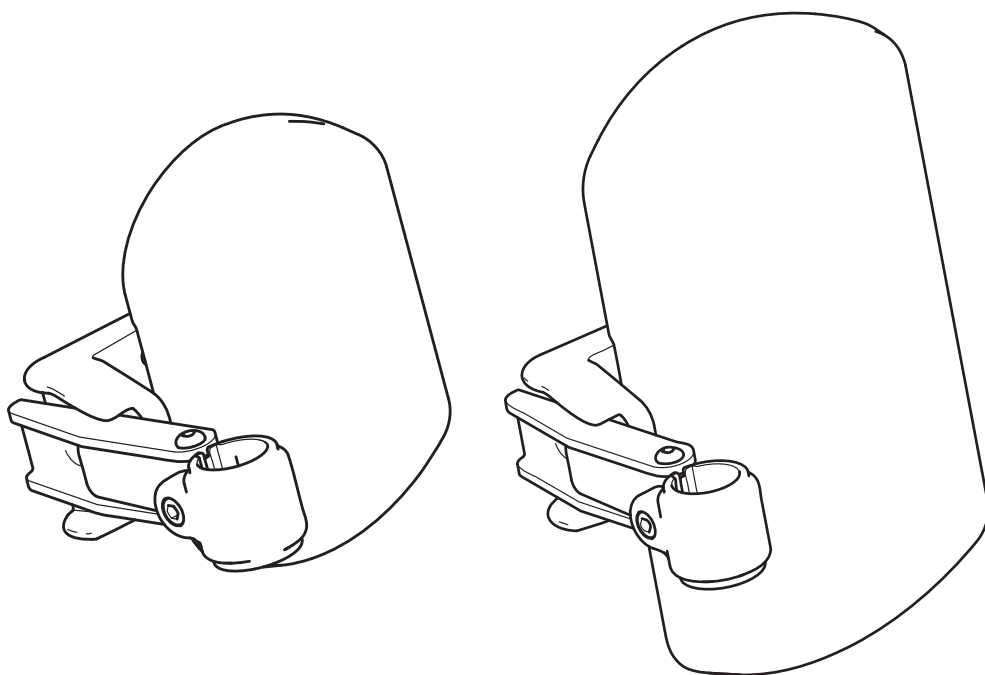

Benämning	Artikelnummer
Vadplatta liten	<input type="checkbox"/> 3013550
Vadplatta standard	<input type="checkbox"/> 3013551



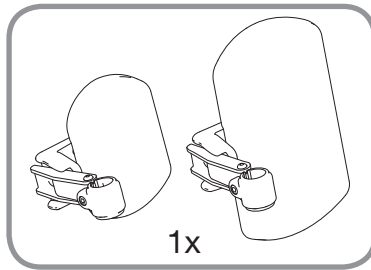
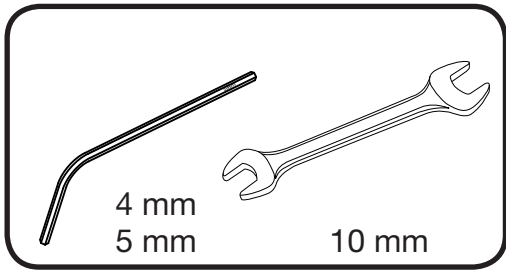

1

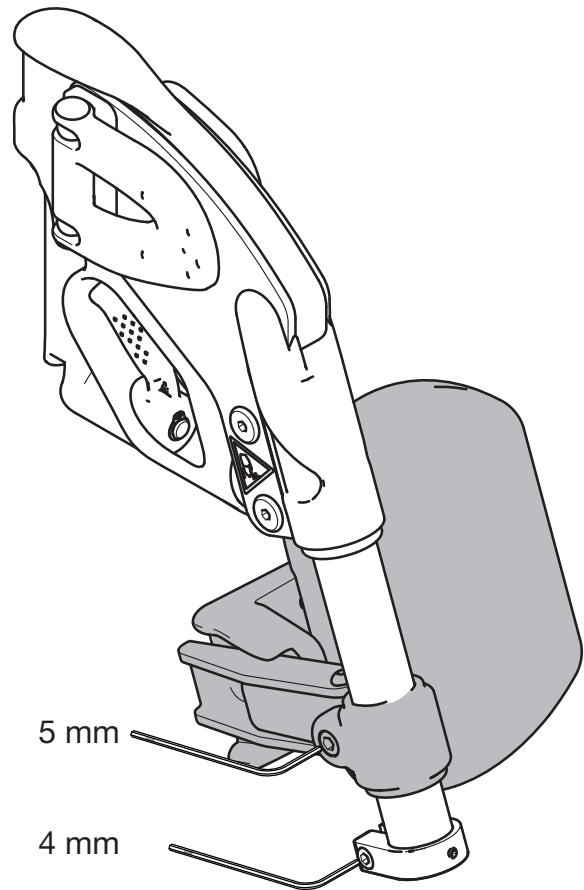
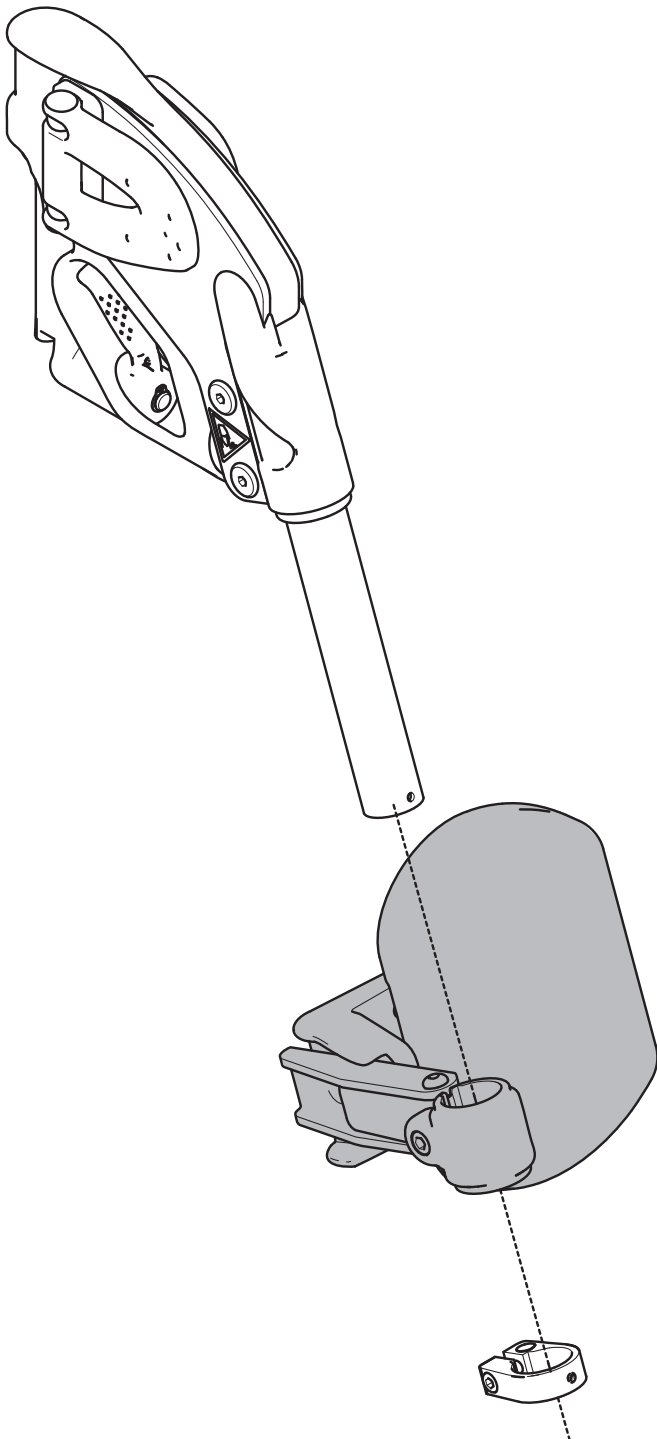

2

5 mm

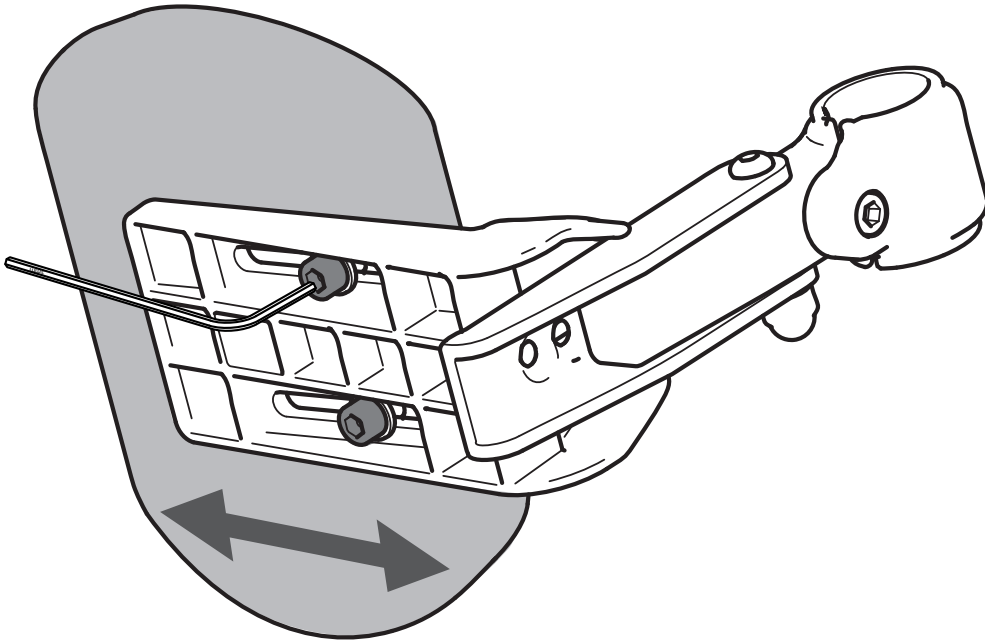

3

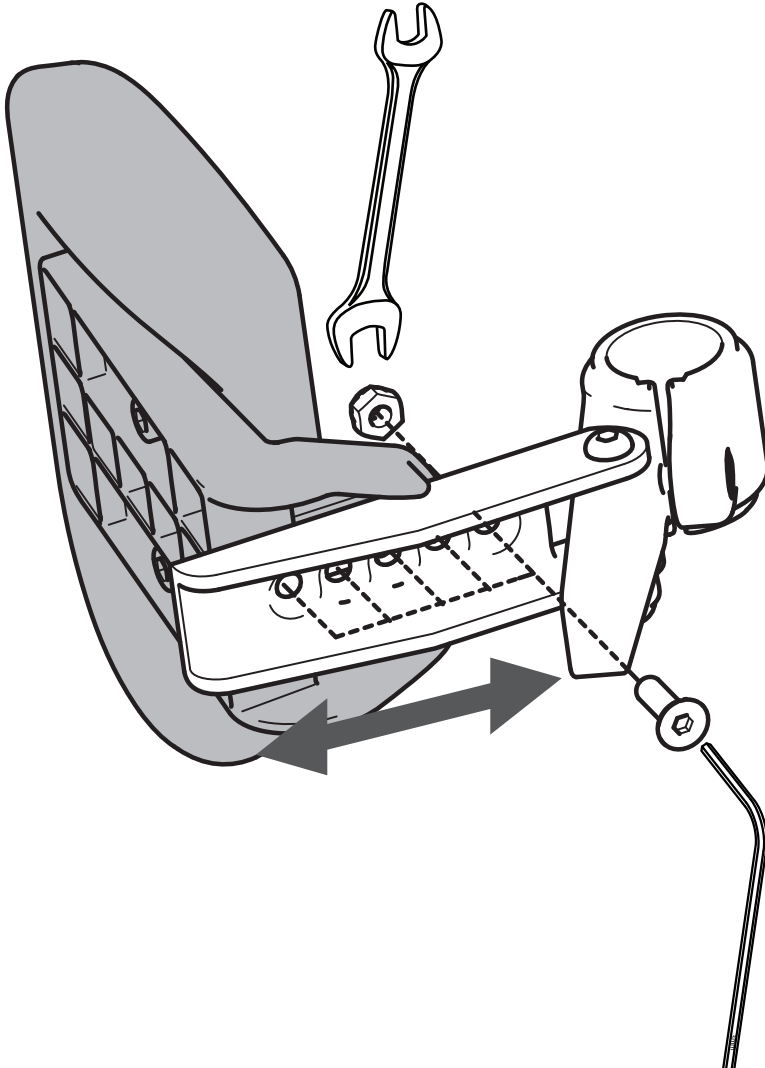

5 mm



Sunrise Medical HCM B.V.
Vossenbeemd 104
5705 CL Helmond
The Netherlands

T: +31 (0)492 59 38 88
E: customerservice@sunrisemedical.nl
www.SunriseMedical.eu



Sunrise Medical AB
Neogatan 5
431 53 Mölndal
Sverige

T: +46 (0) 31 748 37 00
F: +46 (0) 31 748 37 37
E: post@sunrisemedical.se
www.sunrisemedical.se