

# ASSEMBLY INSTRUCTION

## Reflex

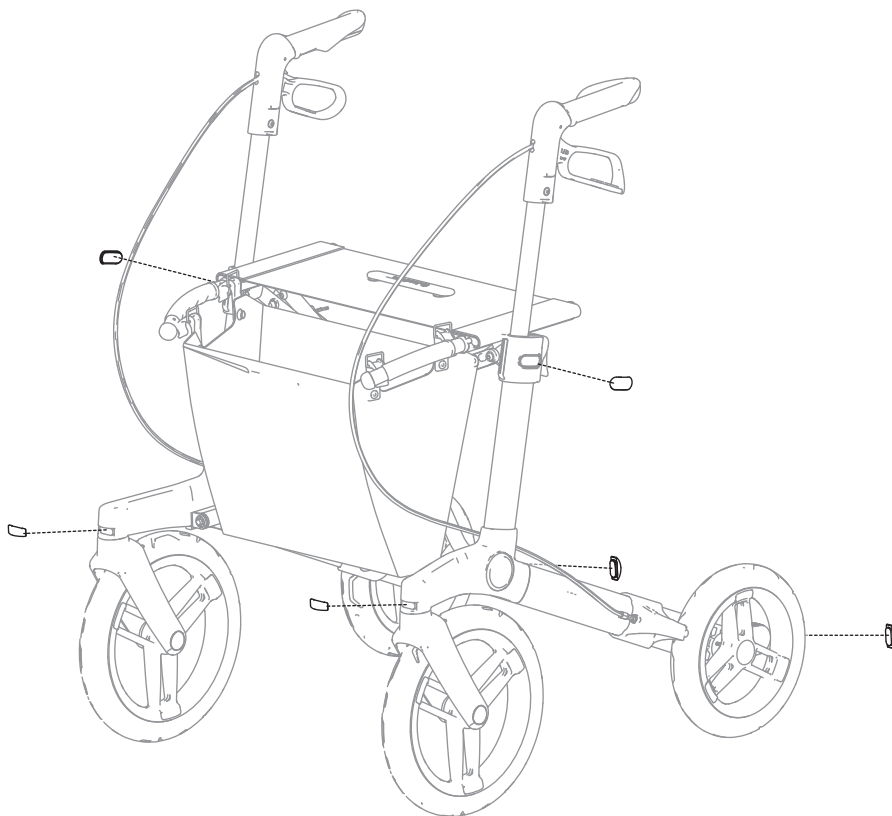

### Description

Reflex Gemino 60/60M models

### Article number

7161250

# GEMINO

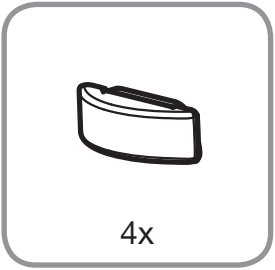

1

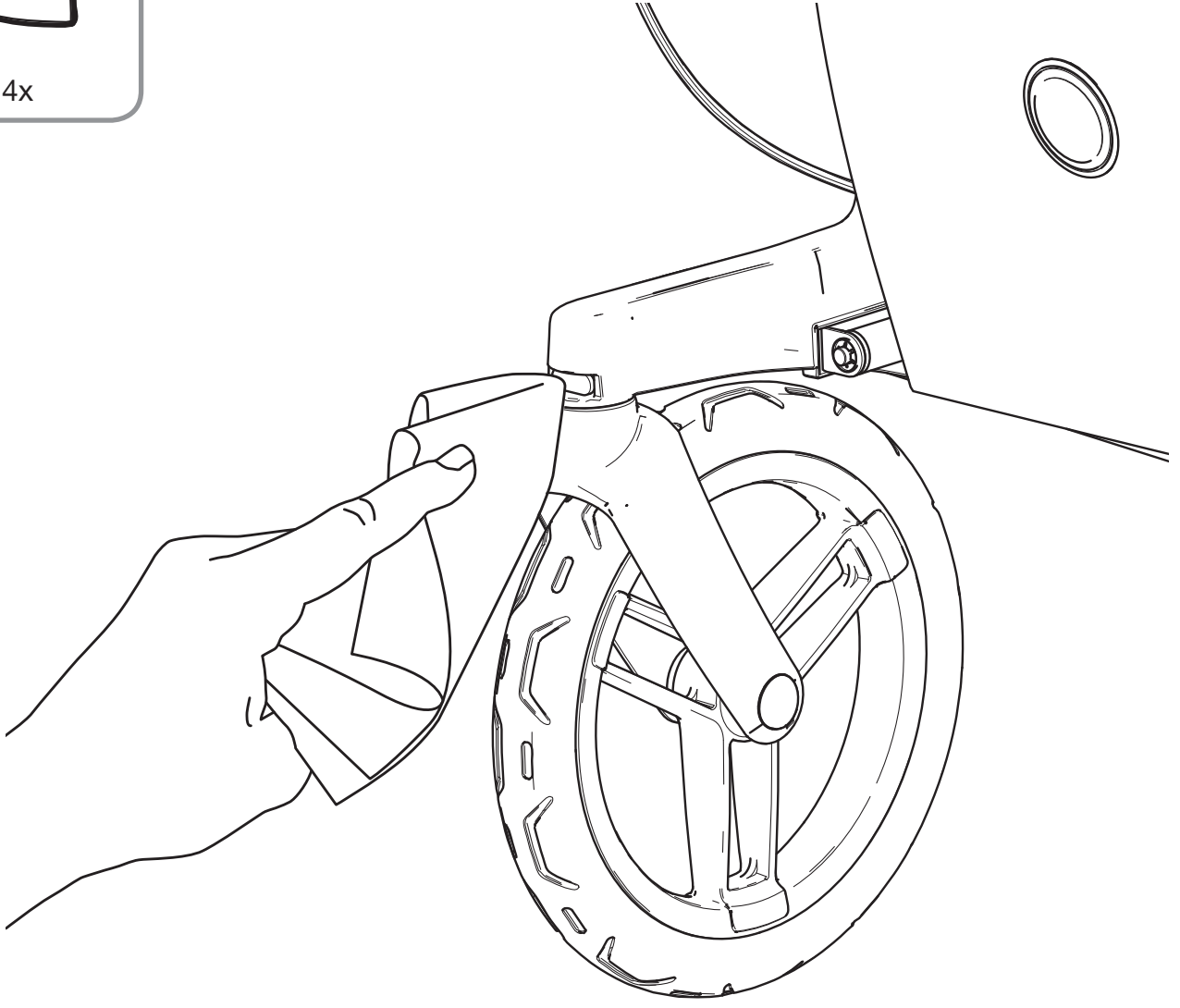

2

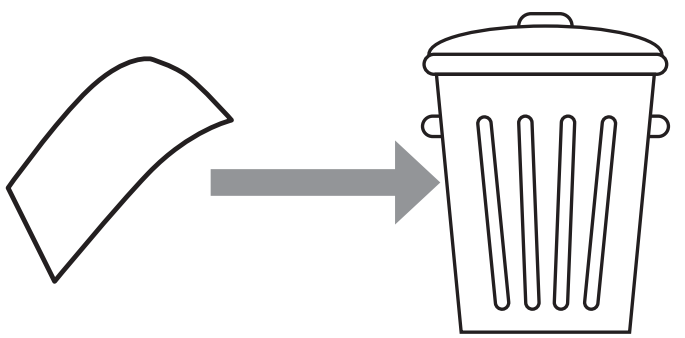
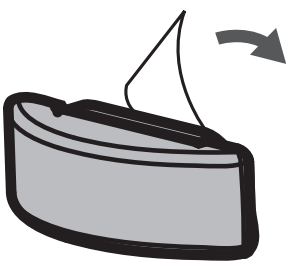

3

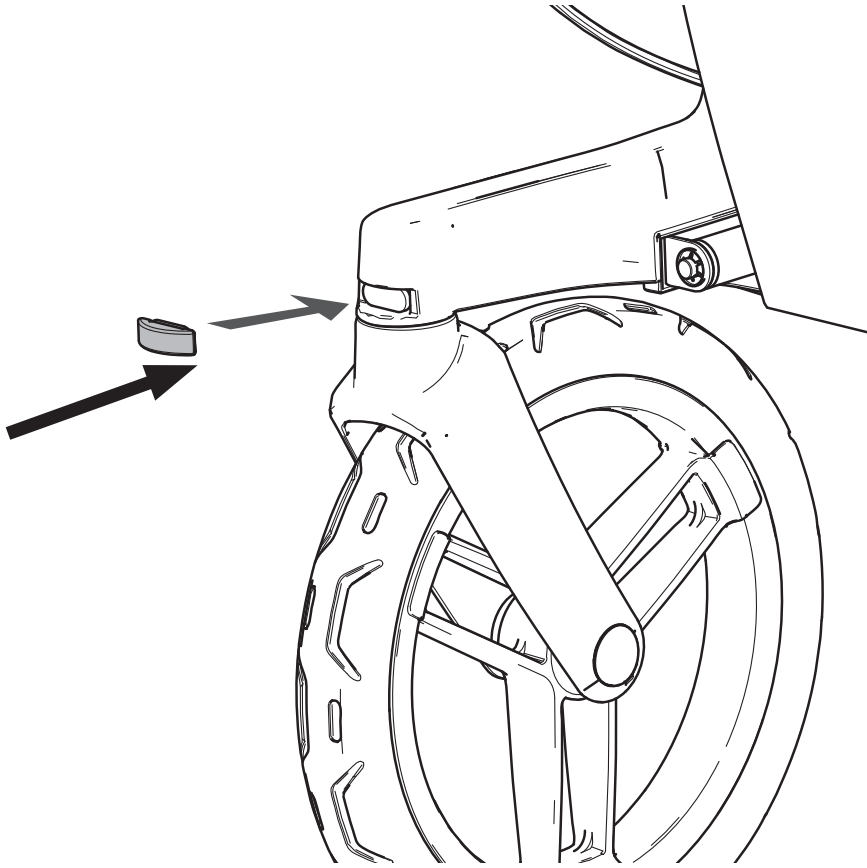

4

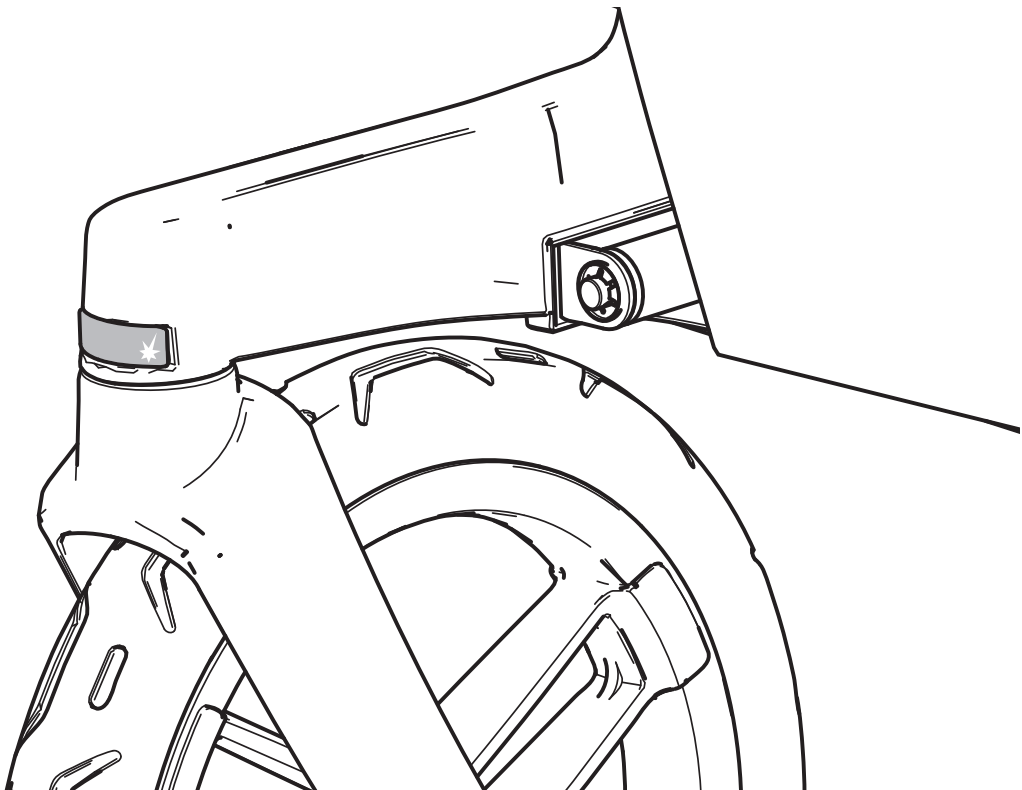



Sunrise Medical HCM B.V.  
Vossenbeemd 104  
5705 CL Helmond  
The Netherlands

T: +31 (0)492 593 888  
[customerservice@sunrisemedical.nl](mailto:customerservice@sunrisemedical.nl)  
[www.SunriseMedical.eu](http://www.SunriseMedical.eu)