

## ASSEMBLY INSTRUCTION

# Calf support

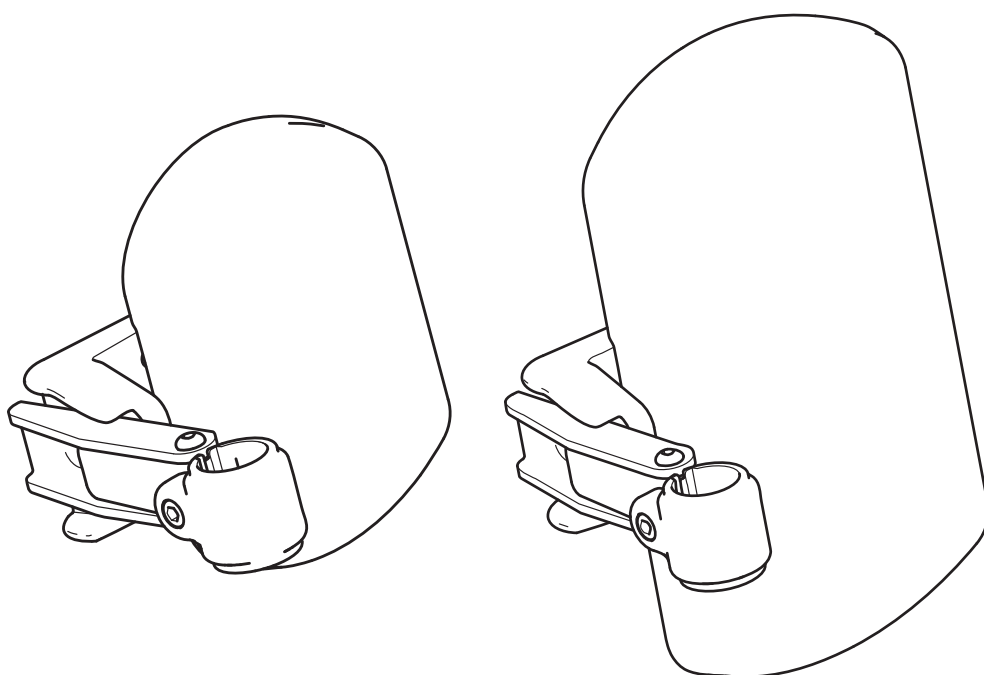

Description	Article number
Medium pad	<input type="checkbox"/> 3013550
Large pad	<input type="checkbox"/> 3013551



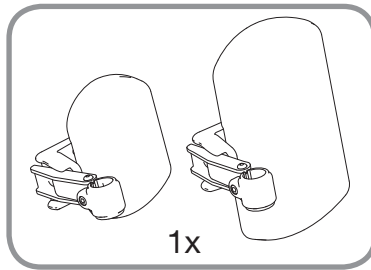
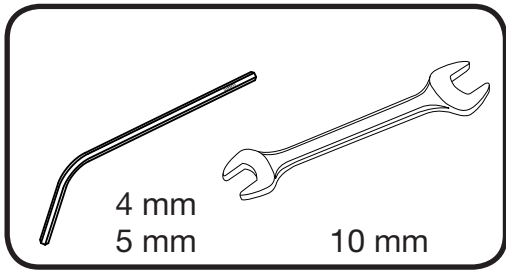

1

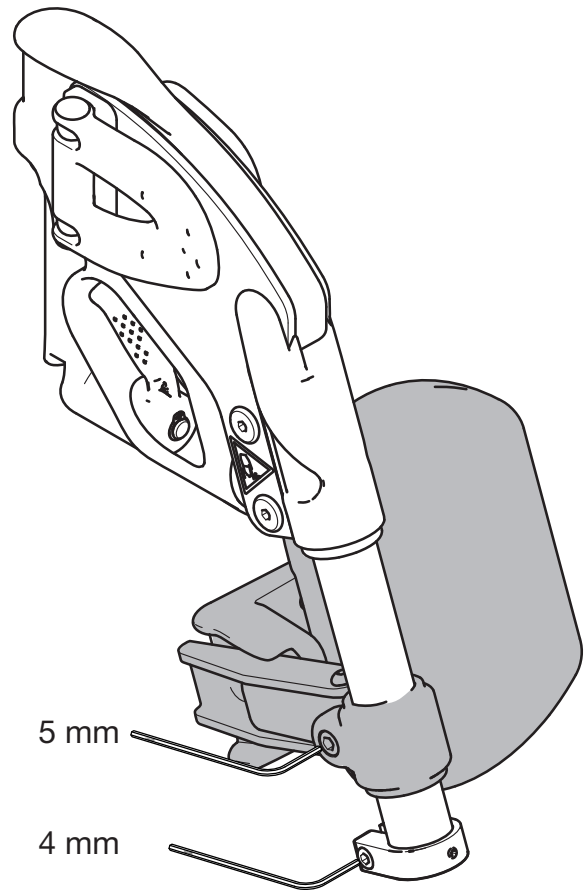
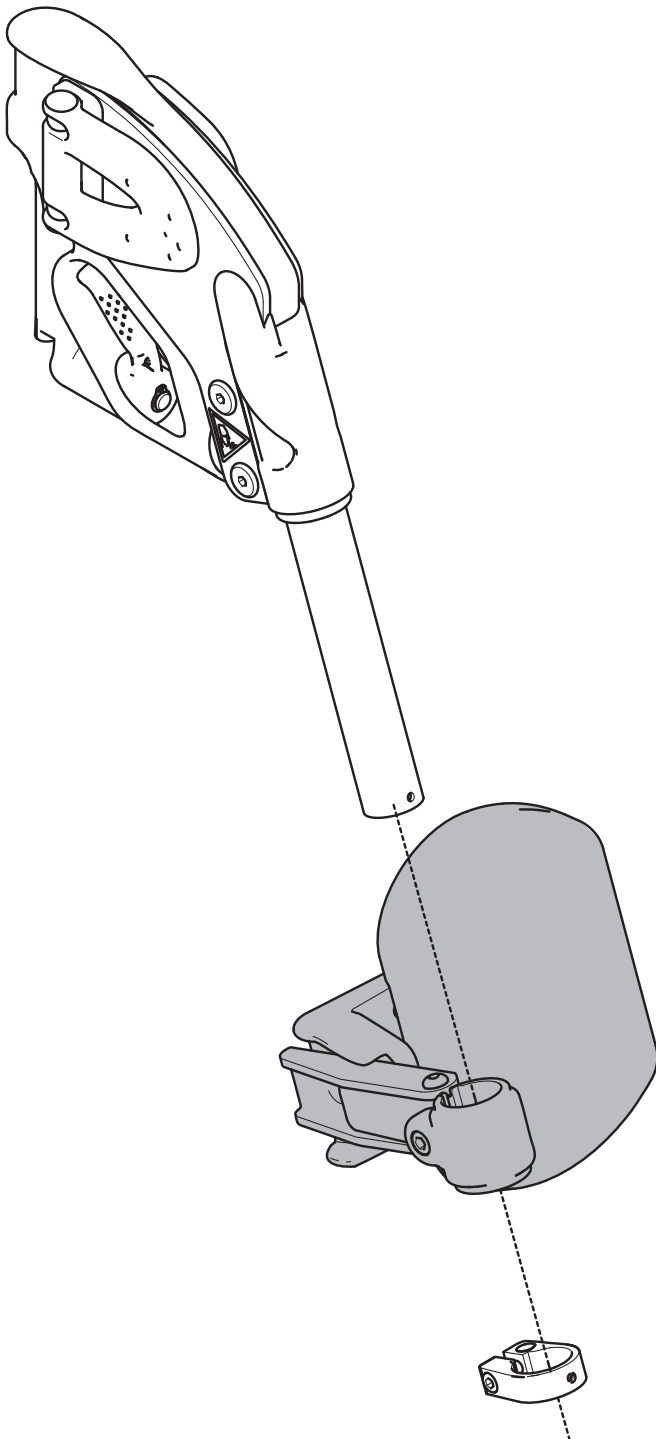

**2**

5 mm

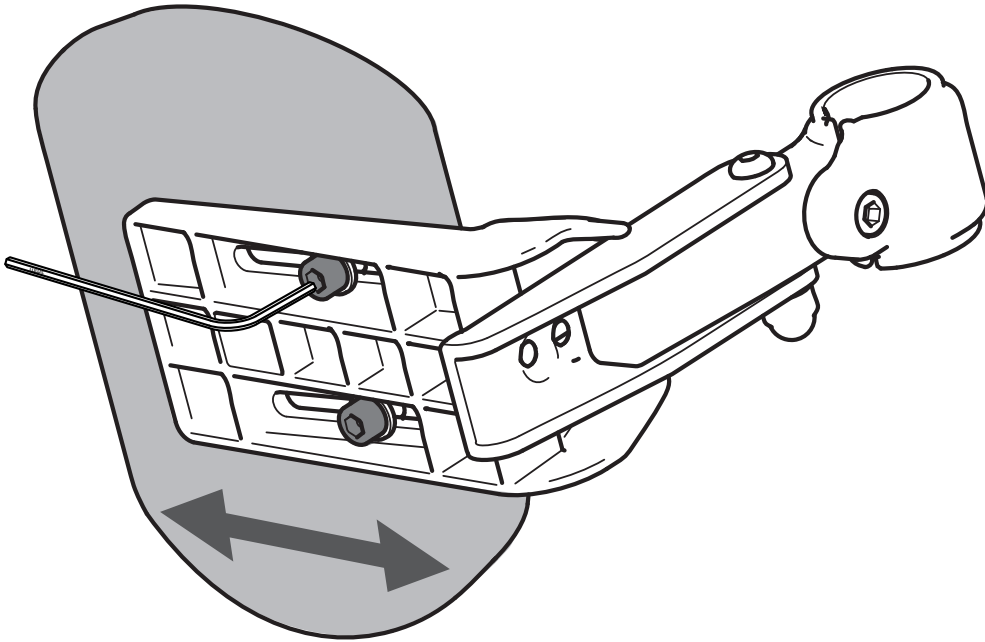

**3**

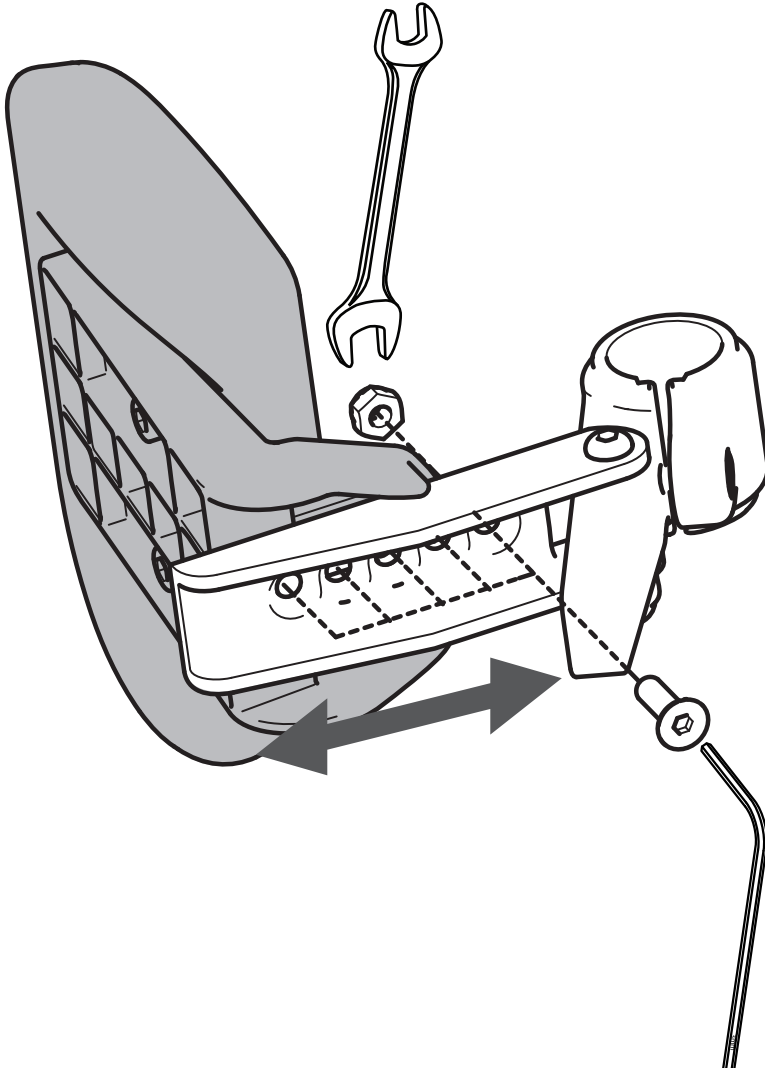

5 mm



Sunrise Medical HCM B.V.  
Vossenbeemd 104  
5705 CL Helmond  
The Netherlands

T: +31 (0)492 593 888  
[customerservice@sunrisemedical.nl](mailto:customerservice@sunrisemedical.nl)  
[www.SunriseMedical.eu](http://www.SunriseMedical.eu)