



Customer Contact Details

<p>Customer Name: _____</p> <p>Advisor: _____</p> <p>Address: _____</p> <p>_____</p> <p>_____</p> <p>Phone: _____</p> <p>Email: _____</p>	<p>Ship to Customer Address: <input type="checkbox"/></p> <p>Shipping Name: _____</p> <p>Shipping Address: _____</p> <p>_____</p> <p>_____</p> <p>Phone: _____</p> <p>Email: _____</p>
---	--

Additional Information

<p>Notes: _____</p> <p>_____</p> <p>_____</p> <p>_____</p>	<p>Current Wheelchair: _____</p> <p>Customer Weight: _____</p> <p>Customer Height: _____</p> <p>Customer Disability: _____</p>
--	--

Other

<p>VAT Exemption Declaration (UK Only):</p> <p>I declare that I am chronically sick or disabled by reason of:</p> <p>_____</p> <p>and that I am receiving from RGK Wheelchairs Ltd, the wheelchair specified herein and I claim relief from Value Added Tax under group 12 of schedule 8 to Value Added Tax Act 1994.</p> <p>Signature: _____ Date: _____</p>	<p>RGK Contact Authorisation:</p> <p>From time to time, RGK would like to send you exclusive information, news and offers on everything RGK, by email or post. We will not pass any of your details to any third party.</p> <p>I would like to be contacted by RGK: <input type="checkbox"/></p> <p>Signature: _____ Date: _____</p>
--	---

Guide: Base product Required option Optional Extra Critical Information Information Needed

PRODUCT STYLE

FXAXZ010 TIGA FX

XA070 Open design

Max User Weight 110kg (241lbs)

PLEASE NOTE: ALL RGK CHAIRS ARE HAND BUILT AND HAVE A MANUFACTURING MEASUREMENT TOLERANCE OF +/- 5MM

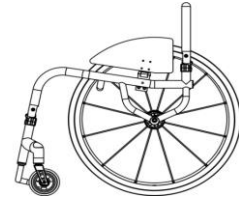

CAD APPROVAL

XW009 QUOTE ONLY (NO CAD FOR APPROVAL)

XW011 ORDER (NO CAD FOR APPROVAL)

XW012 QUOTE CAD drawing for approval
(2 customer amendments ONLY)

XW010 ORDER CAD drawing for approval
(2 customer amendments ONLY)

KEY MEASUREMENTS

XY010 Seat width (*Inside of sideguards*)



XY020 Seat length



XY030 Extra seat length (*Provides additional leg support & hand grip*)



XY050 Front frame height



XY060 Rear frame height

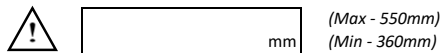

XY070 Frame length



XY072 Castor position

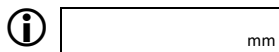

Optimise measurements

XA020 Ergonomic seat

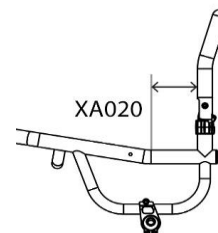
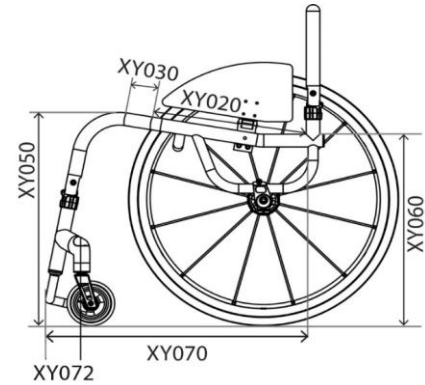
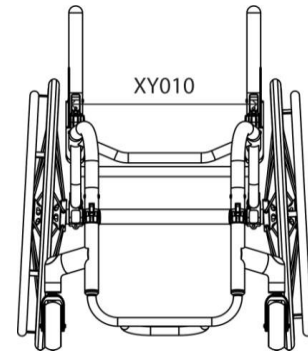
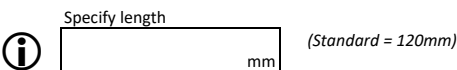

FRONT FRAME AND FOOTREST

Front Frame Options

XY080 Seat taper design

Specify width
 mm

Optimise measurements (XY010 - 100mm)

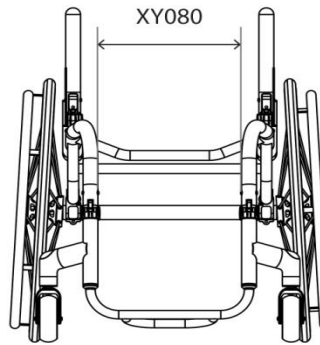

Footrest Design (Choose One)

XY100 Round design

Castor Size	Max Height	With XB200
3"	115mm	165mm
4"	125mm	175mm
5"	135mm	185mm

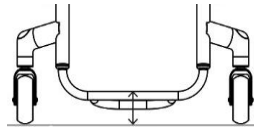

XB200 High level footrest (Only with XB010, XB080 & XB150)

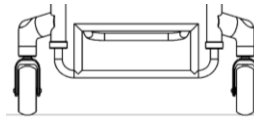

XY105 Square design

Castor Size	Max Height	With XB200
3"	135mm	185mm
4"	145mm	195mm
5"	155mm	205mm

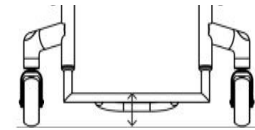

XB200 High level footrest (Only with XB010, XB080 & XB150)

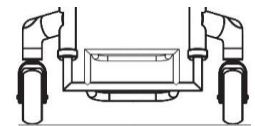

Footrest Individual Measurements

XY115 Front footrest height

 mm

XY120 Rear footrest height

 mm (Std = 20 lower than front height)

XY125 Footrest length

 mm (Std = 100mm) (160mm and over requires heavy duty upgrade XB150)

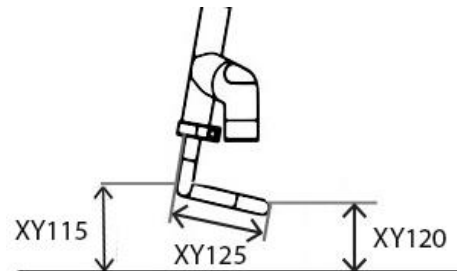

Footrest Style and Cover

FXAXB080 Tubular footrest welded w/ Aluminium plate (Supplied with spacer for +20mm adjustment)

FXAXB120 Clamp-on aluminium plate footrest (Angle/height adjustable)

FXAXB110 Tubular footrest welded w/ Carbon Fibre plate (Supplied with spacer for +20mm adjustment)

Footrest Options



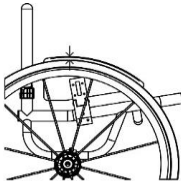
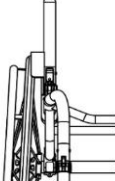
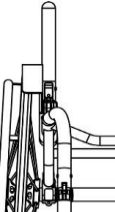
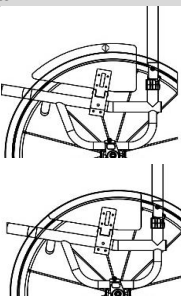
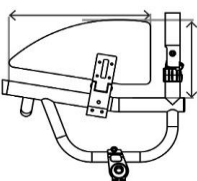

XB165 Rubber grip tape (3M safety walk)

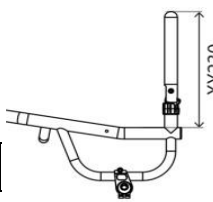
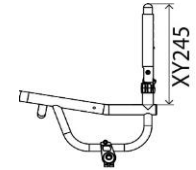
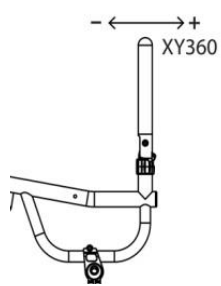
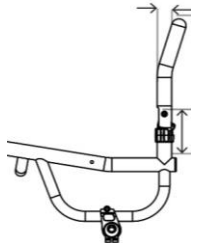
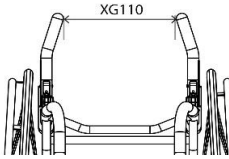
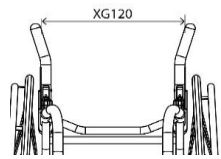
CASTOR WHEELS, FORKS & WHEEL LOCKS										
Castor Wheels 100mm (4")										
<input type="checkbox"/> XC060	Soft roll 4"x1.3" <i>(Black only)</i>									
<input type="checkbox"/> XC110	Aluminium centre 4"x1" <i>(Silver hub and black urethane tyre only)</i>									
<input type="checkbox"/> XC130	Aluminium centre 4"x1.4" <i>(choose colour below)</i>									
<table border="0"> <tr> <td><input type="checkbox"/> Silver hub & black tyre</td> <td><input type="checkbox"/> Gold hub & black tyre</td> <td><input type="checkbox"/> Purple hub & black tyre</td> </tr> <tr> <td><input type="checkbox"/> Black hub & black tyre</td> <td><input type="checkbox"/> Green hub & black tyre</td> <td></td> </tr> <tr> <td><input type="checkbox"/> Red hub & black tyre</td> <td><input type="checkbox"/> Blue hub & black tyre</td> <td></td> </tr> </table>		<input type="checkbox"/> Silver hub & black tyre	<input type="checkbox"/> Gold hub & black tyre	<input type="checkbox"/> Purple hub & black tyre	<input type="checkbox"/> Black hub & black tyre	<input type="checkbox"/> Green hub & black tyre		<input type="checkbox"/> Red hub & black tyre	<input type="checkbox"/> Blue hub & black tyre	
<input type="checkbox"/> Silver hub & black tyre	<input type="checkbox"/> Gold hub & black tyre	<input type="checkbox"/> Purple hub & black tyre								
<input type="checkbox"/> Black hub & black tyre	<input type="checkbox"/> Green hub & black tyre									
<input type="checkbox"/> Red hub & black tyre	<input type="checkbox"/> Blue hub & black tyre									
125mm (5")										
<input type="checkbox"/> XC070	Soft roll 5"x1.3" <i>(Black only)</i>									
<input type="checkbox"/> XC100	Pneumatic Aluminium centre 5"x1" <i>(Grey only)</i>									
<input type="checkbox"/> XC120	Aluminium centre 5"x1" <i>(Silver hub and black urethane tyre only)</i>									
<input type="checkbox"/> XC140	Aluminium centre 5"x1.4" <i>(Silver hub and black urethane tyre only)</i>									
150mm (6")										
<input type="checkbox"/> XC080	Soft roll 6"x1.3" <i>(Black hub / Grey tyre only)</i>									
<input type="checkbox"/> XC145	Aluminium centre 6"x1.4" <i>(Silver hub and black urethane tyre only)</i>									
Castor Forks										
<input type="checkbox"/> XC190	Performance castor fork <i>(Std when no option selected)</i> <i>Note: Colour follows accent</i>									
<input type="checkbox"/> XC192	High trail castor fork <i>Note: Greater distance between contact patch and steering axis reduces flutter at higher speeds. Colour follows accent</i>									
<input type="checkbox"/> XC210	Froglegs suspension castor fork <input type="checkbox"/> Black <input type="checkbox"/> Silver									
Castor Pin Width										
<input checked="" type="checkbox"/> XY330	Castor pin width (XY010 plus 70mm)									
Wheel Lock Options (Choose one)										
<input type="checkbox"/> XD020	Underseat Scissor									
<input type="checkbox"/> XD030	Compact scissor									
<input type="checkbox"/> XD035	Compact scissor with lightweight fixing <i>(Only with fixed centre of gravity)</i>									
<input type="checkbox"/> XD010	Omit wheel locks									
<input type="checkbox"/> XD050	Push to lock									
<input type="checkbox"/> XD046	Out Front push to lock									
<input type="checkbox"/> XD085	Eagle wheel lockss (Indicate colour)									
<input type="checkbox"/> XD086	Eagle WL with L/W fixing (Indicate colour) <i>(Only with fixed centre of gravity)</i>									
<input type="checkbox"/> BLACK <input type="checkbox"/> PURPLE <input type="checkbox"/> RED <input type="checkbox"/> BLUE Black Std if no option selected										

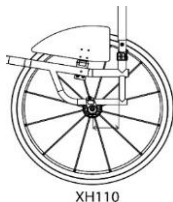
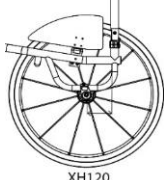
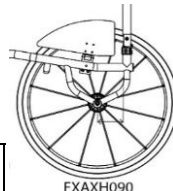
SIDEGUARDS AND ARMRESTS	
<div style="background-color: #eee; text-align: center; padding: 2px; margin-bottom: 5px;">Sideguard</div> <div style="background-color: #eee; text-align: center; padding: 2px; margin-bottom: 5px;">Aluminium Options</div> <p><input type="checkbox"/> XE080 Lift out aluminium</p> <p><input type="checkbox"/> FXAXE130 Fold flat aluminium</p> <div style="background-color: #eee; text-align: center; padding: 2px; margin-bottom: 5px;">Carbon Fibre Options</div> <p><input type="checkbox"/> XE100 Lift out carbon fibre</p> <p><input type="checkbox"/> FXAXE150 Fold flat carbon fibre</p> <div style="background-color: #eee; text-align: center; padding: 2px; margin-bottom: 5px;">ABS Plastic Options</div> <p><input type="checkbox"/> XE120 Lift out ABS plastic</p> <p><input type="checkbox"/> FXAXE170 Fold flat ABS plastic</p>	<div style="background-color: #eee; text-align: center; padding: 2px; margin-bottom: 5px;">Sideguard with Fender</div> <div style="background-color: #eee; text-align: center; padding: 2px; margin-bottom: 5px;">Aluminium Options</div> <p><input type="checkbox"/> XE090 Lift out aluminium with fender</p> <p><input type="checkbox"/> FXAXE140 Fold flat aluminium with fender</p> <div style="background-color: #eee; text-align: center; padding: 2px; margin-bottom: 5px;">Carbon Fibre Options</div> <p><input type="checkbox"/> XE110 Lift out carbon fibre with fender</p> <p><input type="checkbox"/> FXAXE160 Fold flat carbon fibre with fender</p> <div style="background-color: #eee; text-align: center; padding: 2px; margin-bottom: 5px;">Sideguard Measurements</div> <div style="background-color: #eee; text-align: center; padding: 2px; margin-bottom: 5px;">Fender height</div> <p><input type="checkbox"/> 10mm above tyre <i>(Standard)</i></p> <p><input type="checkbox"/> Individual above tyre <i>(Min = 10mm)</i></p> <p><input type="checkbox"/> <input style="width: 60px; height: 15px; border: 1px solid black;" type="text"/> mm</p>  <div style="background-color: #eee; text-align: center; padding: 2px; margin-bottom: 5px;">Fender position</div> <p><input type="checkbox"/> Centre of tyre <i>(Standard if no option selected)</i></p>  <p><input type="checkbox"/> Outside of tyre</p>  <div style="background-color: #eee; text-align: center; padding: 2px; margin-bottom: 5px;">Armrest Options</div> <p><input type="checkbox"/> XF010 Lift out armrest with plastic sideguard <i>(Indicate fixed height)</i></p> <p><input type="checkbox"/> XF020 Lift out armrest with Aluminium sideguard <i>(Indicate fixed height)</i></p> <p style="text-align: center;"><i>Height (Top of seatrail to top of armrest)</i></p> <p><input type="checkbox"/> <input style="width: 60px; height: 15px; border: 1px solid black;" type="text"/> mm</p>
<div style="background-color: #eee; text-align: center; padding: 2px; margin-bottom: 5px;">Sideguard Measurements</div> <div style="background-color: #eee; text-align: center; padding: 2px; margin-bottom: 5px;">Optimised measurements</div> <p><input type="checkbox"/> 25mm above tyre <i>(Follow tyre)</i></p> <p><input type="checkbox"/> Individual above tyre <i>(Follow tyre)</i></p> <p><input type="checkbox"/> <input style="width: 60px; height: 15px; border: 1px solid black;" type="text"/> mm</p> <p><input type="checkbox"/> Level with tyre <i>(Follow tyre)</i></p>  <div style="background-color: #eee; text-align: center; padding: 2px; margin-bottom: 5px;">Individual measurements</div> <p><input type="checkbox"/> Sideguard length</p> <p><input style="width: 60px; height: 15px; border: 1px solid black;" type="text"/> mm</p> <p><input type="checkbox"/> Sideguard height</p> <p><input style="width: 60px; height: 15px; border: 1px solid black;" type="text"/> mm</p> 	

BACKREST	
Backrest Height	
<input type="checkbox"/> XY230 Fixed height backrest (Maximum 400mm) Specify height <input type="text" value=""/> mm	<input type="checkbox"/> XY245 Adjustable height backrest (Maximum height 400mm) (+/-25mm) Specify height <input type="text" value=""/> mm
	
Backrest Design	
<input checked="" type="checkbox"/> FXAXG060 Folding backrest with Q Lock (Black)	
Ergonomic Options	
<input checked="" type="checkbox"/> XY360 Backrest angle -5 -3 0 +3 +5 <input type="checkbox"/> <input type="checkbox"/> <input type="checkbox"/> <input type="checkbox"/> <input type="checkbox"/> Individual <input type="text" value=""/> Deg (Max -7/+7 Deg)	<input type="checkbox"/> XG100 Ergonomic backrest Vertical height <input type="text" value=""/> mm Rearward position <input type="text" value=""/> mm
	
<input type="checkbox"/> XG110 Inward taper (inside of backrest posts) Specify width or per side <input type="text" value=""/> mm	<input type="checkbox"/> XG120 Outward flare (inside of backrest posts) Specify width or per side <input type="text" value=""/> mm
	
Push handle Options	
<input type="checkbox"/> XG070 Screw in push handles (N/A with XY245)	
<input type="checkbox"/> XG080 Flip down push handles (N/A with XY245)	
<input type="checkbox"/> XG085 Flip down push handles height adjustable (N/A with XY245)	
<input type="checkbox"/> XG097 Integrated push handle (Quickie design)	

CAMBER BAR	
<p style="text-align: center; background-color: #eee; margin-bottom: 5px;">Adjustable Centre of Gravity</p> <p><input type="checkbox"/> XH110 Square back adjustable centre of gravity (25-150mm) (Max seat width 500mm)</p> <p>Specify measurement <input style="width: 100px;" type="text"/> mm</p>  <p style="text-align: center; font-size: small;">XH110</p> <p><input type="checkbox"/> XH120 Round back adjustable centre of gravity (60-150mm)</p> <p>Specify measurement <input style="width: 100px;" type="text"/> mm</p>  <p style="text-align: center; font-size: small;">XH120</p>	<p style="text-align: center; background-color: #eee; margin-bottom: 5px;">Fixed Centre of Gravity</p> <p><input type="checkbox"/> FXAXH090 V-style fixed centre of gravity (25-125mm)</p> <p>Specify measurement <input style="width: 100px;" type="text"/> mm</p>  <p style="text-align: center; font-size: small;">FXAXH090</p>
<p style="text-align: center; background-color: #eee; margin-bottom: 5px;">Specify Camber Angle</p> <p><input checked="" type="checkbox"/> XY390 Camber angle</p> <p><input type="checkbox"/> 0 <input type="checkbox"/> 1 <input type="checkbox"/> 2 <input type="checkbox"/> 3 <input type="checkbox"/> 5</p>	<p style="text-align: center; background-color: #eee; margin-bottom: 5px;">Specify Camber Angle</p> <p><input checked="" type="checkbox"/> XY390 Camber angle</p> <p><input type="checkbox"/> 0 <input type="checkbox"/> 1 <input type="checkbox"/> 2 <input type="checkbox"/> 3 <input type="checkbox"/> 5</p>
Camber Bar Options	
<p><input type="checkbox"/> FXAXK227 Standard Axle pin (120 or 130mm)</p> <p><input type="checkbox"/> FXAXK226 100mm Titanium Axle pin (Fixed Axle Only)</p>	<p><input type="checkbox"/> XK220 Titanium 130mm quick release axle pins (pair) (N/A with XK010, XK070 or FXAXK226)</p> <p><input type="checkbox"/> XK240 Quad release axle nuts (pair) (N/A with FXAXK226)</p>
Anti-Tip Options	
<p><input type="checkbox"/> XJ010 Swingaway anti tip LEFT side (Only with square back frame. Not with XH040)</p> <p><input type="checkbox"/> XJ020 Swingaway anti tip RIGHT side (Only with square back frame. Not with XH040)</p>	<p><input type="checkbox"/> XJ100 Single sport anti tip (centre mounted)</p>

REAR WHEELS	
Rear Wheel Size	
<input type="checkbox"/> XY420 24" Wheels	<input type="checkbox"/> XY430 25" Wheels
Rear Wheel Gap	
<input checked="" type="checkbox"/> XY460 Rear wheel gap <div style="display: flex; align-items: center; margin-top: 5px;"> <div style="margin-right: 10px;"> <input type="checkbox"/> 15 <input type="checkbox"/> 20 <input type="checkbox"/> 25 </div> <div style="border: 1px solid black; width: 100px; height: 20px; display: flex; align-items: center; justify-content: center;"> Individual mm </div> </div>	
Rear Wheel Options	
<input type="checkbox"/> XK010 Fusion 16 spoke <i>(Silver Hub, black spokes)</i>	<input type="checkbox"/> XK320 Spinergy XLX 12 spoke <i>(cross/radial spoked)</i>
<input type="checkbox"/> XK050 Spinergy LX 12 spoke	<input type="checkbox"/> XK060 Spinergy SPOX 18 spoke
<input type="checkbox"/> XK150 Spinergy CLX 18 carbon blade spoke N/A IN SILVER HUB	<input type="checkbox"/> XK070 Spinergy BLXL 18 blade spoke N/A IN SILVER HUB
Spinergy Colour Options: 	
<input type="checkbox"/> Black spokes	<input type="checkbox"/> White spokes
<input type="checkbox"/> Red spokes	<input type="checkbox"/> Blue spokes
<input type="checkbox"/> Purple spokes	<input type="checkbox"/> Orange spokes
<input type="checkbox"/> Yellow spokes	<input type="checkbox"/> Pink spokes
<input type="checkbox"/> Green spokes	<input type="checkbox"/> XK180 Individual spoke design <i>(Specify colour)</i>
<i>Inside: _____</i>	
<i>Outside: _____</i>	
Spinergy Anodise Options	
<input type="checkbox"/> XK190 Black hub <i>(std option)</i>	<input type="checkbox"/> XK200 Silver hub <i>(n/a with BLXL/CLX)</i>
<input type="checkbox"/> XK202 Purple hub/rims <i>(LX, XLX & BLXL only)</i>	<input type="checkbox"/> XK203 Blue hub/rims <i>(LX, XLX & BLXL only)</i>
<input type="checkbox"/> XK201 Red hub/rims <i>(LX, XLX & BLXL only)</i>	<input type="checkbox"/> XK204 Gold hub/rims <i>(LX, XLX & BLXL only)</i>
<input type="checkbox"/> XK205 Individual hub/rims Select colour: _____	
Supply Without Wheels	
<input type="checkbox"/> XK040 Supply without Wheels	 <div style="display: flex; justify-content: space-around; margin-top: 5px;"> <div style="border: 1px solid black; padding: 2px;">Wheel Type: _____</div> <div style="border: 1px solid black; padding: 2px;">Tyre Type: _____</div> </div>
Handrim Position / Options	
<input type="checkbox"/> XY480 Narrow set handrim	<input type="checkbox"/> XY485 Wide set handrim
<input type="checkbox"/> XL090 Remove excess mounting tabs <i>(recommended for small wheel gaps)</i>	
Handrim Styles	
<input type="checkbox"/> XL010 Aluminium hard anodised 6 tab <i>(Standard if no option selected)</i>	<input type="checkbox"/> XL040 Titanium 6 tab
<input type="checkbox"/> XL160 Elipse 6 tab <i>(replacement for Surge)</i>	<input type="checkbox"/> XL035 Natural Fit LT
<input type="checkbox"/> XL020 Tetra grip 6 tab	<input type="checkbox"/> XL150 Carbolife Gekko <input type="checkbox"/> Black <input type="checkbox"/> Silver
<input type="checkbox"/> XL100 Para grip 6 tab	<input type="checkbox"/> XL170 Carbolife Curve L (Black)
Tyre Options	
<input type="checkbox"/> XM010 Kenda <input type="checkbox"/> Grey <input type="checkbox"/> Blue <input type="checkbox"/> Red <i>(Std)</i>	<input type="checkbox"/> XM060 Schwalbe One <i>(24",25" only)</i>
<input type="checkbox"/> XM130 Kenda black	<input type="checkbox"/> XM050 Kenda K885 mountain bike tyre <i>(24",25" only)</i>
<input type="checkbox"/> XM020 Schwalbe Marathon Plus	
<input type="checkbox"/> XM040 Shox solid airless	
Inner Tube Valve Options	
<input type="checkbox"/> XY500 Schraeder inner tube valve <i>(Standard if no option selected)</i>	<input type="checkbox"/> XY490 Presta inner tube valve
	
Wheel Accessories	
<input type="checkbox"/> XK310 Offroad wheel set 24" rim with handrim, MTB tyre and axle pins <i>(Replaces 25" wheel with XM010)</i>	<input type="checkbox"/> XK300 Offroad wheel set 22" rim with handrim, MTB tyre and axle pins <i>(Replaces 24" wheel with XM010)</i>

FINISH OPTIONS			
Frame & Component Finish			
<input type="checkbox"/> XN010 Powder coated frame		<input type="checkbox"/> XN150 Powder coated components <i>(Frame colour if not specified)</i>	
Frame Comp.	<u>Gloss</u>	Frame Comp.	<u>Matt</u>
<input type="checkbox"/>	<input type="checkbox"/> Black gloss 103	<input type="checkbox"/>	<input type="checkbox"/> Black matt 105
<input type="checkbox"/>	<input type="checkbox"/> White gloss 100	<input type="checkbox"/>	<input type="checkbox"/> White matt 101
<input type="checkbox"/>	<input type="checkbox"/> Grey gloss 132	<input type="checkbox"/>	<input type="checkbox"/> Grey matt 131
<input type="checkbox"/>	<input type="checkbox"/> Cream gloss 135	<input type="checkbox"/>	<input type="checkbox"/> Light grey matt 133
<input type="checkbox"/>	<input type="checkbox"/> Red gloss 108	<input type="checkbox"/>	<input type="checkbox"/> Navy blue matt 152
<input type="checkbox"/>	<input type="checkbox"/> Yellow gloss 120		
<input type="checkbox"/>	<input type="checkbox"/> Forest green gloss 143		
<input type="checkbox"/>	<input type="checkbox"/> Green gloss 107		
<input type="checkbox"/>	<input type="checkbox"/> Dark blue gloss 151		
<input type="checkbox"/>	<input type="checkbox"/> Royal blue gloss 154		
<input type="checkbox"/>	<input type="checkbox"/> Blue gloss 174		
<input type="checkbox"/>	<input type="checkbox"/> Duckegg blue gloss 141		
<input type="checkbox"/>	<input type="checkbox"/> Pink gloss 188		
<input type="checkbox"/>	<input type="checkbox"/> Orange gloss 180		
<input type="checkbox"/>	<input type="checkbox"/> Purple gloss 157		
<input type="checkbox"/>	FXAXN030 Brushed frame <i>(All parts black unless XN160 chosen)</i>	<input type="checkbox"/>	XN160 Brushed components
<input type="checkbox"/>	FXAXN050 Polished frame <i>(All parts black unless XN170 chosen)</i>	<input type="checkbox"/>	XN170 Polished components
		<input type="checkbox"/>	XN200 Individual paint colour (State Colour/RAL code)
		Frame	Comp
		<input type="checkbox"/>	<input type="checkbox"/>

Accent Colour			
<u>Note:</u> Accent colour includes, forks & castor caps.			
<input type="checkbox"/>	Black accent	<input type="checkbox"/>	Silver accent
<input type="checkbox"/>	Red accent	<input type="checkbox"/>	Blue accent
<input type="checkbox"/>	Purple accent	<input type="checkbox"/>	Carbon accent
		<input type="checkbox"/>	XN250 Individual Accent Colour

UPHOLSTERY			
Seat Upholstery			
<input type="checkbox"/>	XP040 Seat sling adjustable tension with straps	<input type="checkbox"/>	XR050 Carbon fibre seat plate
Backrest Upholstery			
<input type="checkbox"/>	XP050 Airtech backrest strap adjustable	<input type="checkbox"/>	XP060 Backrest upgrade to full leather <i>(Black)</i>
		<input type="checkbox"/>	XP070 Backrest upgrade to leather corners <i>(Black)</i>
Backrest Stitching Colour			
<input type="checkbox"/>	Silver	<input type="checkbox"/>	Black
<input type="checkbox"/>	Red	<input type="checkbox"/>	Orange
<input type="checkbox"/>	Blue	<input type="checkbox"/>	Purple
<input type="checkbox"/>	Individual:	_____	
RGK Logo Colour			
<input type="checkbox"/>	White (Std)	<input type="checkbox"/>	Green
<input type="checkbox"/>	Red	<input type="checkbox"/>	Orange
<input type="checkbox"/>	Blue	<input type="checkbox"/>	Purple
<input type="checkbox"/>	Individual:	_____	
Model Logo Colour			
<input type="checkbox"/>	White (Std)	<input type="checkbox"/>	Green
<input type="checkbox"/>	Red	<input type="checkbox"/>	Orange
<input type="checkbox"/>	Blue	<input type="checkbox"/>	Purple
<input type="checkbox"/>	Individual:	_____	
Backrest Accessories			
<input type="checkbox"/>	XP110 Backrest with zip pocket	<input type="checkbox"/>	XP170 Individual backrest embroidery <i>PLEASE COMPLETE PAGE 11</i>

CUSHION	
Cushion foam options	
<input type="checkbox"/> XP080	Cushion foam <i>(select density and size below)</i>
<input type="checkbox"/> Soft (CMS040)	<input type="checkbox"/> Medium (CMS050)
<input type="checkbox"/> 50mm	<input type="checkbox"/> 75mm <input type="checkbox"/> 100mm
Cushion cover Upgrades	
<input type="checkbox"/> XP085	Nylon cushion cover <i>(Black)</i>
<input type="checkbox"/> XP090	Air Lite cushion cover <i>(Black)</i>
<input type="checkbox"/> XP100	Leather cushion cover <i>(Black)</i>
Jay Products - PLEASE PROVIDE JAY ORDER FORM	
<input type="checkbox"/> JAY Cushion <i>(Price dependant on size / option)</i>	<input type="checkbox"/> Jay Order form attached
<input type="checkbox"/> JAY Backrest <i>(Price dependant on size / option)</i>	<input type="checkbox"/> Jay Order form attached
<input type="checkbox"/> JAY Whitmyer Headrest <i>(Price dependant on size / option)</i>	<input type="checkbox"/> Jay Order form attached
ACCESSORIES	
<input type="checkbox"/> XR080	Frontwheel assembly <i>(Only with tubular style footrest)</i>
<input type="checkbox"/> XP120	Frame protectors Neoprene zip fasten <i>(Black)</i>
<input type="checkbox"/> XP420	Frame protectors Nylon velcro fasten <i>(Black)</i>
<input type="checkbox"/> XR010	Seat pouch velcro attach <i>(Black)</i>
<input type="checkbox"/> XR200	Rucksack with RGK logo (Black)
<input type="checkbox"/> XR100	FX carry bag
<input checked="" type="checkbox"/> XR090	Tool kit
<input checked="" type="checkbox"/> XS060	Calf strap

ADDITIONAL NOTES

INDIVIDUAL BACKREST EMBROIDERY

PLEASE PROVIDE JPEG IMAGE AT TIME OF ORDER AND NOTE POSITION BELOW



SPEC NOTES:

OFF SPEC REQUEST*

(please specify below the page number(s) and details to which the off spec request applies.

OFF SPEC REQUEST APPROVED *(for internal RGK office only)*

x

RGK Internal Sign-off

Off spec requests require a feasibility study which may increase order price and lead time. Any dimension/ option/ frame request not listed on the order form will be treated as an off spec request.*