

Deliver to:
 Name:
 Street:
 Town: Postal code:
 E-Mail:
 Tel: Fax:

Deliver to:
 Name:
 Street:
 Town: Postal code:
 E-Mail:
 Tel: Fax:



Order date:
 Purchase order:
 Number required:

Marked for:
 Sunrise order no:

- Order
- Calculation
- Built 4 me

- = Standard
- = Cost option
- = No cost option

Customer service fax number: 0845 605 66 89

Max. user weight: **125kg**
USER WEIGHT kg
 Mandatory information to ensure correct configuration

Basic price ! £10,500.00

CLIENT MEASUREMENT

Seat width in cm

34	36	38	40	42
○	○	○	○	○
W34	W36	W38	W40	W42

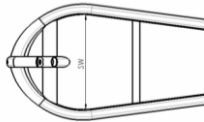

£	
----------	--

FRAME		
SRK010010	<input checked="" type="radio"/> Std frame	
SRK010900	<input type="checkbox"/> Built-4-Me	(see B4M order form) POA

BACKREST		
SRK030001	<input type="checkbox"/> Standard backrest - height and angle adjustable	
SRK030005	<input type="checkbox"/> Performance backrest	£346.15

Backrest Position		
SRK030003	<input type="checkbox"/> 25 SRK030004 <input type="checkbox"/> 30	
SRK030007	<input type="checkbox"/> high (35-44cm) SRK030008 <input type="checkbox"/> low (25-36cm)	
SRK030002	<input type="checkbox"/> Standard neck support - height and depth adjustable	
SRK030006	<input type="checkbox"/> Comfort neck support - height and depth adjustable	£128.80

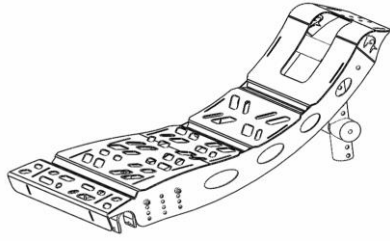

Standard Backrest

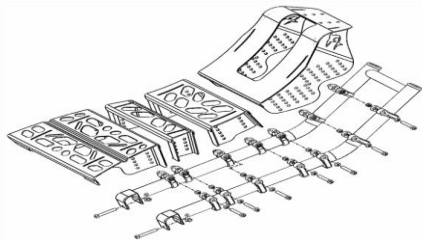

Performance Backrest

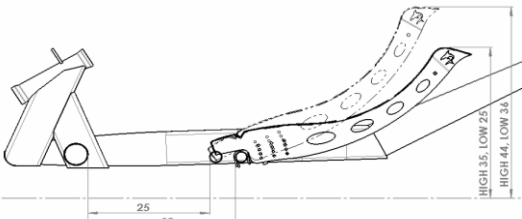

SRK030003 or SRK030004

SRK030007 or SRK030008

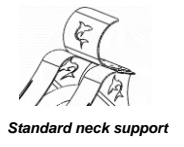

Standard neck support

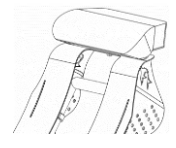

Comfort neck support

FORK		
SRK070001	<input type="checkbox"/> Fork with adjustable crank housing	(chosen measurements are +/- 2 cm w/o changing of parts, adjustable, see Owners' Manual)
SRK070901	<input type="checkbox"/> Fork fixed welded crank housing	
SRK070900	<input type="checkbox"/> Built-4-Me	(see B4M order form) POA

		height in cm				
		41	43	45	47	49
depth in cm	D25	2.5	○	○	○	○
	D35	3.5	○	○	○	○
	D45	4.5	○	○	○	○
	D55	5.5	○	○	○	○
	D65	6.5	○	○	○	○
	D75	7.5	○	○	○	○
	D85	8.5	○	○	○	○
	D95	9.5	○	○	○	○
	D105	10.5	○	○	○	○
	D115	11.5	○	○	○	○
D125	12.5	○	○	○	○	
		H41	H43	H45	H47	H49

adjusting range for fork with adjustable crank housing

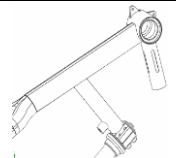
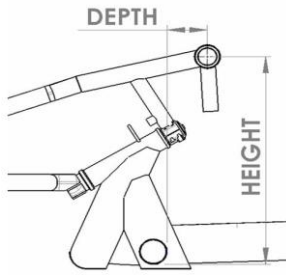

SRK070901

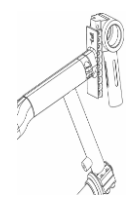

SRK070001

QUICKIE SHARK RS

● = Standard ○ = No cost option □ = Cost option

£

CRANK

SRK080001 ● V Crank

SRK080900 □ Built-4-Me

(see B4M order form)

POA

Length in cm

	15.5	16	16.5	17	17.5
SRK080032	○	○	○	○	○
SRK080034	○	○	○	○	○
SRK080036	○	○	○	○	○
SRK080038	○	○	○	○	○
SRK080040	○	○	○	○	○

width in cm

SRK080155 SRK080160 SRK080165 SRK080170 SRK080175

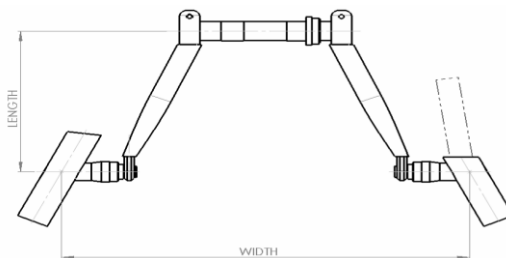

SRK080200 ● Handle

SRK080240 ○ diameter 47x32mm

SRK080230 ○ diameter 37x21mm

SRK080005 ○ Chain plate kit small (22 / 34 / 48 teeth)

SRK080006 ○ Chain plate kit large (34 / 42 / 52 teeth)

SEAT UPHOLSTERY

SRK020001 ● Seat sling

SRK020002 ○ Seat cushion with cover, black

Foam composite, thickness: 3cm (medium)

LEGREST & FOOTPLATES

● Footrest length adjustable

SRK050002 ○ for long legs (70 - 100cm)

SRK050003 ○ for short legs (45 - 70cm)

SRK050004 ○ Performance footrest

(long legs only)

SRK050900 □ Built-4-Me

(see B4M order form)

POA

GEAR

SRK070100 ○ Trigger shifter 3x10 Speed

(fitted to right-hand side of the fork)

SRK070105 □ Double tap control (SRAM)

(1)

£261.05

FRONT WHEEL (incl. tyre)

SRK070201 ● DT-SWISS 559 Performance Front Wheel (Clincher)

SRK070202 □ DT-SWISS 571 RS Front Carbon Wheel (full carbon tubular rim incl. tubular tyres and brake shoes)

£1,038.45 (4)

SRK070203 □ DT-SWISS Additional 571 RS Front Carbon Wheel (full carbon tubular rim incl. tyres and brake shoes)

£1,038.45 (4)

SRK070204 ○ Omit front wheel

REAR WHEEL

SRK070301 ● DT-SWISS 559 Performance Rear Wheels (Clincher)

SRK070302 □ DT-SWISS 571 RS Rear Carbon Wheels (full carbon tubular rim incl tyres and brake shoes)

(pair)

£2,078.05 (3) (4)

SRK070303 □ DT-SWISS Additional 571 RS Rear Carbon Wheel (full carbon tubular rim incl. tyres & brake shoes)

(pair)

£2,078.05 (3) (4)

SRK070304 □ Omit rear wheels

-£282.90

SRK070401 ○ Quick release axle

(only with aluminium axle tube SRK070801+SRK07802)

SRK070402 ○ Threaded axle

WHEEL CAMBER

SRK070701 ● 0°

SRK070920 □ Built-4-Me

(see B4M order form)

POA

AXLE TUBE

SRK070801 ● Aluminium anodised

SRK070802 □ Aluminium powder coated

(in frame colour)

£60.95

SRK070803 □ Carbon (3)

£346.15

REAR COLLISION PROTECTOR

SRK070501 ● Rear collision protector 559/571

SRK070910 □ Built-4-Me

(see B4M order form)

POA

BRAKE

SRK060001 ● Performance brake lever (2)

SRK060002 ○ handle mounted left

SRK060003 ○ handle mounted right

SRK060004 □ Reverse brake (2)

£1,212.10

SRK060005 ● Parking brake

(Brake lever can be locked)

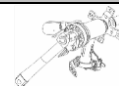

SRK060004

(1): Dual control shifter, fitted to right-hand side of the fork, including the brake

(2): Not available with Dual control 3x10 Speed (SRK070105)

(3): Only in combination with threaded axle SRK070402

(4): Max. 100 kg user weight

QUICKIE SHARK RS

● = Standard C = No cost option □ = Cost option

£

ACCESSORIES

SRK090001	<input type="checkbox"/> Front fender (with quick fitting)	£87.40
SRK090009	<input type="checkbox"/> Front and rear light <i>(Includes universal bracket)</i>	£103.50
SRK050200	<input type="checkbox"/> Knee pad <i>(pair)</i>	£87.40
SRK090004	<input type="checkbox"/> Waist belt	
SRK090005	<input checked="" type="checkbox"/> Protection flag	
SRK090006	<input type="checkbox"/> Mirror	£60.95
SRK090007	<input type="checkbox"/> Bottle holder	£95.45
SRK090008	<input type="checkbox"/> Universal bracket for light, mirror, speedometer and GPS	£60.95

COLOURS

32	<input type="checkbox"/> Signal White	SRK010429	24	<input type="checkbox"/> Tutti Fruitti Orange	SRK010421
02	<input type="checkbox"/> Brilliant Silver	SRK010402	27	<input type="checkbox"/> Graphite Metallic	SRK010424
03	<input type="checkbox"/> Silver matt	SRK010403	29	<input type="checkbox"/> Black	SRK010426
06	<input type="checkbox"/> Sun Yellow	SRK010405	31	<input type="checkbox"/> Matt Black	SRK010428
14	<input type="checkbox"/> Blue	SRK010412	33	<input type="checkbox"/> Pink	SRK100125
15	<input type="checkbox"/> Brilliant Marine	SRK010413	34	<input type="checkbox"/> Dark Chocolate Metallic	SRK100126
16	<input type="checkbox"/> Matt Marine	SRK010414	35	<input type="checkbox"/> Sky Blue	SRK100127
19	<input type="checkbox"/> Brilliant Purple	SRK010416	36	<input type="checkbox"/> Cyan Metallic	SRK100128
21	<input type="checkbox"/> Red Ruby	SRK010418	37	<input type="checkbox"/> Mars Red (Orange)	SRK100129
22	<input type="checkbox"/> Brilliant Red	SRK010419	40	<input type="checkbox"/> Kiwi	SRK100132
23	<input type="checkbox"/> Matt Red	SRK010420	41	<input type="checkbox"/> Flamingo Glitter	SRK100133
			42	<input type="checkbox"/> Matt Anthracite	SRK100134

Upholstery colour

SRK020401	<input checked="" type="checkbox"/> Black
-----------	---

Anodized colour package for footrest, axle tube and collision protector

SRK070002	Black	<input checked="" type="checkbox"/>	
SRK070003	Orange	<input type="checkbox"/>	173.65

Label colour (decals)

SRK010450	<input type="checkbox"/> White
SRK010451	<input type="checkbox"/> Orange/Black

Dimensions:

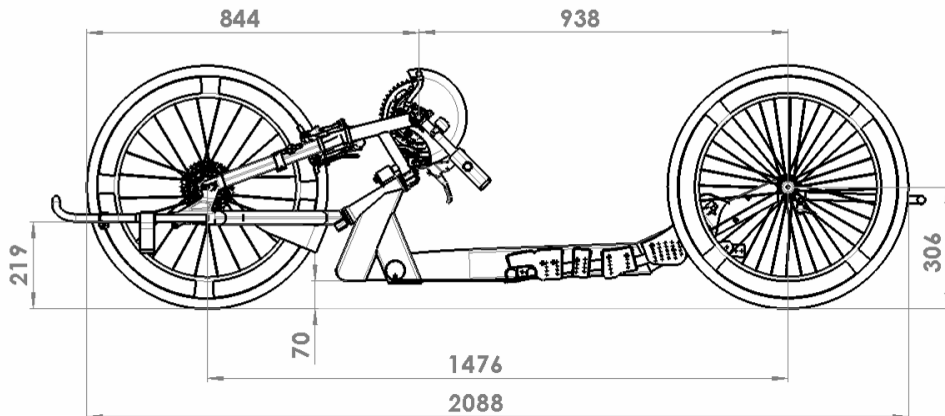

Shark RS - Base Price	£10,500
Option price	£
Total Price	£

Sunrise Medical Customer service Address: Thorns Road, Brierley Hill, West Midlands, DY5 2LD Tel. 0845 605 66 88 Fax. 0845 605 66 89	E-mail: orders@sunmed.co.uk Website: www.SunriseMedical.co.uk
---	---