



Shark RS

Rechnungsadresse
 Name:
 Straße:
 Ort: PLZ:
 Land:
 Telefon Nr.: Fax:

Versandadresse
 Name:
 Straße:
 Ort: PLZ:
 E-Mail:
 Telefon Nr.: Fax:

Bestelldatum:
 Bestellung:
 Kundennummer:



Kommission:
 Unsere Auftragsnummer:

- Bestellung
- Kostenvoranschlag
- FMG (Für Mich Gebaut)
 Verlängerte Lieferzeit und andere Konditionen

Grundpreis 7.948,00 €
Art. Nr.: 47200000

Zugelassen bis 125 kg

Stand 01.01.2024 Preise gültig bis auf Widerruf

● = Standard □ = Aufpreis ○ = Kostenlose Option

Grundmaße

Sitzbreite in cm				
34	36	38	40	42
<input type="radio"/>	<input type="radio"/>	<input type="radio"/>	<input type="radio"/>	<input type="radio"/>
W34	W36	W38	W40	W42

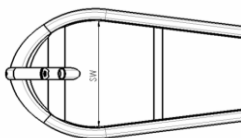

Rahmen			€
SRK010010	● Std Rahmen		Std.
SRK010900	□ FMG	(Machbarkeitsprüfung)	nach Aufwand
FMG-MF01-3160-01	□ Shark RS Attack Rahmen (kurzer Rahmen, 20" Antriebsrad (406) - Anpassung nötig)	(Machbarkeitsprüfung)	nach Aufwand

Rücken			€
SRK030001	○ Standard Rücken - höhen- und winkelverstellbar		0,-
SRK030005	□ Performance Rücken		437,-
Rücken Position			
SRK030003	○ 25 cm	SRK030004 ○ 30 cm	0,-
SRK030007	○ Hoch (35 - 44 cm)	SRK030008 ○ Niedrig (25 - 36 cm)	0,-
SRK030002	□ Standard Nackenstütze - höhen- und tiefenverstellbar		131,-
SRK030006	□ Komfort Nackenstütze - höhen- und tiefenverstellbar		193,-

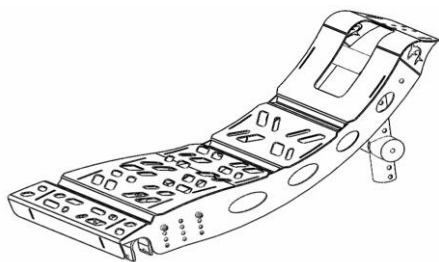

Standardrückenlehne

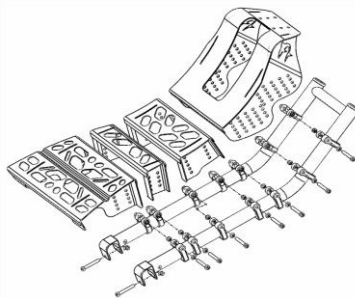

Performance Rückenlehne

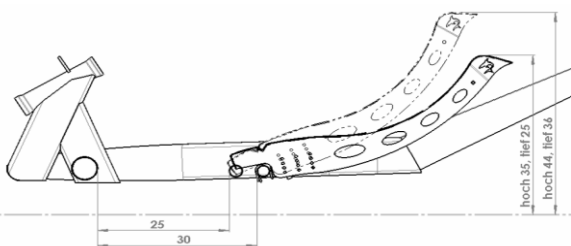

SRK030003 oder SRK030004

SRK030007 oder SRK030008

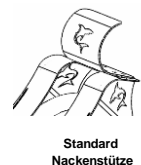

Standard Nackenstütze



Komfort Nackenstütze

Gabel			€
SRK070001	○ Gabel mit verstellbarem Kurbelgehäuse		0,-
SRK070901	○ Gabel mit fest verschweißtem Kurbelgehäuse		0,-
SRK070900	□ FMG	(Machbarkeitsprüfung)	nach Aufwand

		Höhe in cm				
		41	43	45	47	49
Tiefe in cm	D25	2,5	○	○	○	○
	D35	3,5	○	○	○	○
	D45	4,5	○	○	○	○
	D55	5,5	○	○	○	○
	D65	6,5	○	○	○	○
	D75	7,5	○	○	○	○
	D85	8,5	○	○	○	○
	D95	9,5	○	○	○	○
	D105	10,5	○	○	○	○
	D115	11,5	○	○	○	○
	D125	12,5	○	○	○	○
			H41	H43	H45	H47

■ Einstellbereich der Gabel mit verstellbarem Kurbelbereich

▨ nicht möglich

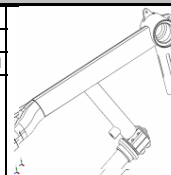
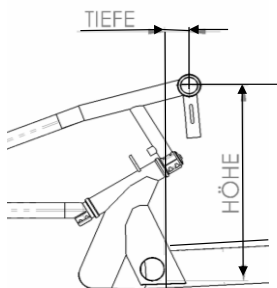

Kurbelgehäuse verschweißt

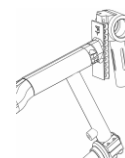

Kurbelgehäuse verstellbar

RGK Shark RS

● = Standard ○ = Kostenlose Option □ = Aufpreis

€

Kurbel

SRK080001	● V Kurbel		Std.																																														
SRK080900	□ FMG (Sonderbau)	(Machbarkeitsprüfung)	nach Aufwand																																														
	<table border="1"> <thead> <tr> <th colspan="2"></th> <th colspan="5">Länge in cm</th> </tr> <tr> <th colspan="2"></th> <th>15,5</th> <th>16</th> <th>17</th> <th>17</th> <th>17,5</th> </tr> </thead> <tbody> <tr> <th rowspan="5">Breite in cm</th> <th>32</th> <td>○</td><td>○</td><td>○</td><td>○</td><td>○</td> </tr> <tr> <th>34</th> <td>○</td><td>○</td><td>○</td><td>○</td><td>○</td> </tr> <tr> <th>36</th> <td>○</td><td>○</td><td>○</td><td>○</td><td>○</td> </tr> <tr> <th>38</th> <td>○</td><td>○</td><td>○</td><td>○</td><td>○</td> </tr> <tr> <th>40</th> <td>○</td><td>○</td><td>○</td><td>○</td><td>○</td> </tr> </tbody> </table>			Länge in cm							15,5	16	17	17	17,5	Breite in cm	32	○	○	○	○	○	34	○	○	○	○	○	36	○	○	○	○	○	38	○	○	○	○	○	40	○	○	○	○	○			
		Länge in cm																																															
		15,5	16	17	17	17,5																																											
Breite in cm	32	○	○	○	○	○																																											
	34	○	○	○	○	○																																											
	36	○	○	○	○	○																																											
	38	○	○	○	○	○																																											
	40	○	○	○	○	○																																											
SRK080032																																																	
SRK080034																																																	
SRK080036																																																	
SRK080038																																																	
SRK080040																																																	
<small>SRK080155 SRK080160 SRK080165 SRK080170 SRK080175</small>																																																	
SRK080200	● Griff		Std.																																														
SRK080240	○ Durchmesser 47 x 32 mm	SRK080230 ○ Durchmesser 37 x 21 mm		0,-																																													
SRK080005	○ Kettenblatt Kombination (22 / 34 / 48 Zähne)			0,-																																													
SRK080006	○ Kettenblatt Kombination (34 / 42 / 52 Zähne)			0,-																																													

Sitzbespannung

SRK020001	● Sitzbespannung Nylon		Std.	
SRK020002	□ Sitzkissen mit Bezug, schwarz			128,-

Fußraste

	● Fußrasten verstellbar		Std.	
SRK050002	○ Für lange Beine (70 - 100 cm)	SRK050003 ○ Für kurze Beine (45 - 70 cm)		0,-
SRK050004	□ Performance Fußraste	(ausschließlich lange Beine)		117,-
SRK050900	□ FMG	(Machbarkeitsprüfung)		nach Aufwand

Schaltung

SRK070071	○ Triggerschalter 11 fach (Kassette: 11-40)	(montiert am Griff rechts)		0,-
SRK070072	□ Brems/Schalthebel kombiniert, 11 fach	(1)		307,-

Vorderrad (inklusive Reifen)

SRK070201	● 559 Performance Vorderrad (Drahtreifen)		Std.	
SRK070204	□ ohne Vorderrad			0,-

Hinterräder

SRK070301	● 559 Performance Hinterräder (Drahtreifen)		Std.	
SRK070304	□ ohne Hinterräder			0,-
SRK070401	○ Steckachsen	(nur mit Achsenrohr SRK070801+SRK07802)		0,-
SRK070402	○ Schraubachsen			0,-

Radsturz

SRK070701	● 0,5°		Std.	
-----------	--------	--	------	--

Hinterradachsen

SRK070801	● Aluminium eloxiert		Std.	
SRK070802	□ Aluminium pulverbeschichtet	(in Rahmenfarbe)		117,-
SRK070803	□ Carbon	(3)		224,-

Auffahrschutz

SRK070501	● Auffahrschutz 559/571		Std.	
SRK070910	□ FMG	(Machbarkeitsprüfung)		nach Aufwand

Bremsen

SRK060001	● Performance Bremshebel (2)		Std.	
SRK060002	○ Griff links montiert	SRK060003 ○ Griff rechts montiert		0,-
SRK060004	□ Rücktrittbremse (2)	(Kettenblatt 22/34/48; Kurbellänge 175mm lang & 400mm breit)		996,-
SRK060005	● Parkbremse		Std.	

(1): Kombiniertes Brems-/Schalthebel ist an der Gabel rechts montiert
 (2): Nicht verfügbar mit kombiniertem Brems-/Schalthebel SRK070105

Weitere Informationen finden Sie unter www.SunriseMedical.de

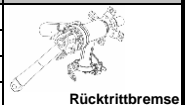

RGK Shark RS

● = Standard ○ = Kostenlose Option □ = Aufpreis

€

Zubehör

SRK090001	<input type="checkbox"/>	Schutzblech vorne, mit Schnellanbindung		38,-
SRK090009	<input type="checkbox"/>	Front- & Rückscheinwerfer	(inkl. Universalhalter)	112,-
SRK050200	<input type="checkbox"/>	Kniepolster	(Paar)	100,-
SRK090004	<input type="checkbox"/>	Beckengurt		197,-
SRK090005	●	Signalfahne		Std.
SRK090006	<input type="checkbox"/>	Rückspiegel		74,-
SRK090007	<input type="checkbox"/>	Flaschenhalter	(am Rahmen verschraubt)	117,-
SRK090008	<input type="checkbox"/>	Universalhalter für Licht, Rückspiegel, Tachometer oder z.B. GPS		38,-

Rahmenfarben

<input type="checkbox"/> 32 - Signalweiß	0,-	<input type="checkbox"/> 22 - Brillantrot	101,-
<input type="checkbox"/> 29 - Schwarz	0,-	<input type="checkbox"/> 23 - Mattrot	101,-
<input type="checkbox"/> 31 - Mattschwarz	0,-	<input type="checkbox"/> 19 - Brillantviolett	101,-
<input type="checkbox"/> 02 - Brillantsilber	0,-	<input type="checkbox"/> 41 - Flamingo Glitter	101,-
<input type="checkbox"/> 42 - Matt Anthrazit	0,-	<input type="checkbox"/> 15 - Brillantmarine	101,-
<input type="checkbox"/> 27 - Graphitmetallic	0,-	<input type="checkbox"/> 16 - Mattmarin	101,-
<input type="checkbox"/> 14 - Blau	0,-	<input type="checkbox"/> 35 - Himmelblau	101,-
<input type="checkbox"/> 06 - Sonnengelb	0,-	<input type="checkbox"/> 36 - Cyan-Metallic	101,-
<input type="checkbox"/> 24 - Tutti Frutti Orange	0,-	<input type="checkbox"/> 46 - Mambagrün	101,-
<input type="checkbox"/> 33 - Pink	0,-	<input type="checkbox"/> 40 - Kiwi	101,-
<input type="checkbox"/> 21 - Rubinrot	0,-	<input type="checkbox"/> 37 - Marsrot	101,-
		<input type="checkbox"/> 03 - Mattsilber	101,-
		<input type="checkbox"/> 34 - Dark Chocolate Metallic	101,-

Bespannung

SRK020401	<input type="checkbox"/>	Schwarz
-----------	--------------------------	---------

Farb Paket für eloxierte Fußraste, Hinterradachse und Auffahrschutz

SRK070002	Schwarz	●	Std.
SRK070003	Orange	□	145,-

Farbe von Schriftzug/Logo

SRK010450	<input type="checkbox"/>	Weiss
SRK010451	<input type="checkbox"/>	Orange / Schwarz

Weitere Kommentare für "Für mich gebaut" (Sonderbau):

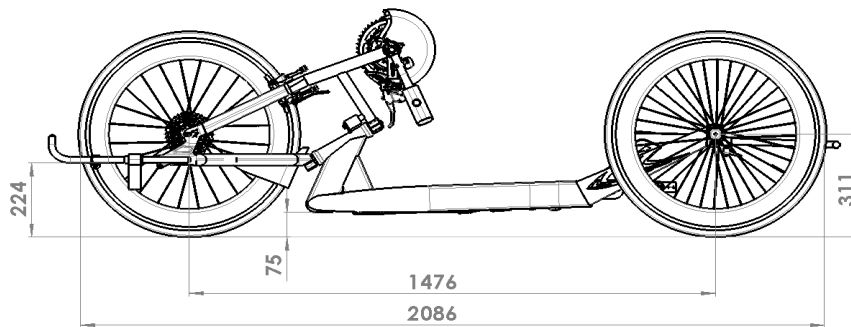

SHARK RS - Grundpreis

€ 7.948,-

Summe der Mehrpreise / Minderpreise	€.....
Verpackung und Frachtkostenanteil	€.....
Preis ohne MwSt.	€.....
MwSt. 19%	€.....
Gesamtpreis	€.....

Sunrise Medical GmbH
 Kahlbachring 2-4 / D-69254 Malsch/HD
 Tel.: +49 (0) 7253 980 - 0
 Fax: +49 (0) 7253 980 - 222



MADE IN
MALSCH/GERMANY

Weitere Informationen finden Sie unter www.SunriseMedical.de