

AI

ALUMINIUM 7020



CE

Customer Contact Details

Customer Name: _____

Advisor: _____

Address: _____

Phone: _____

Email: _____

Ship to Customer Address:

Shipping Name: _____

Shipping Address: _____

Phone: _____

Email: _____

Additional Information

Notes: _____

Current Wheelchair: _____

Customer Weight: _____

Customer Height: _____

Customer Disability: _____

Other

Guide:

- Base product
- Required option
- Optional Extra
- Critical Information
- Information Needed

PRODUCT STYLE

- TGAXZ010 TIGA**
- XA070 Open design
- XA080 Closed design
- TGAXA085 Crash tested upgrade
- XA170 Heavy duty frame *(Spinergy SLX 24 spoke wheels also required)*

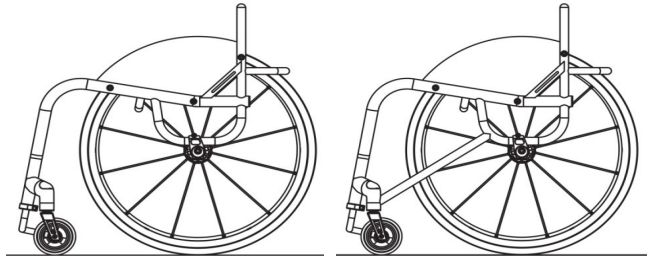

XA070 - Open design

XA080 - Closed design

Max User Weight 125kg (275lbs)
Max User Weight XA170 Heavy Duty Frame 158kg (348lbs)

PLEASE NOTE: ALL RGK CHAIRS ARE HAND BUILT AND HAVE A MANUFACTURING MEASUREMENT TOLERANCE OF +/- 5MM

CAD APPROVAL

- XW009 QUOTE ONLY (NO CAD FOR APPROVAL)
- XW011 ORDER (NO CAD FOR APPROVAL)
- XW012 QUOTE / CAD drawing for approval (2 customer amendments ONLY)
- XW010 ORDER CAD drawing for approval (2 customer amendments ONLY)

KEY MEASUREMENTS

- XY010 Seat width *(Inside to inside of sideguards)*
Seat width
- XY020 Seat length
Seat length
- XY030 Extra Seat Length *(Provides additional leg support & hand grip)*
Extra Seat Length
- XY050 Front frame height
Front frame height
- XY060 Rear frame height
Rear frame height
- XY070 Frame length
Frame length
- XY072 Castor position
Castor position
- XA020 Ergonomic seat
Ergonomic seat

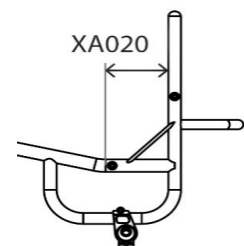
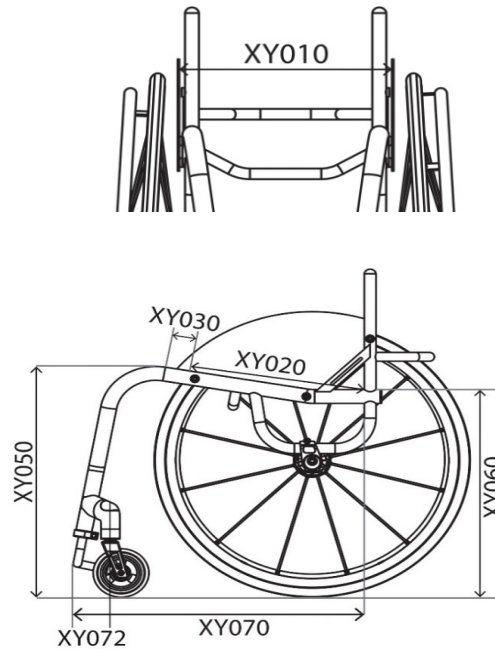

FRONT FRAME AND FOOTREST

Front Frame Options

- XY080 Seat taper design
Seat taper design

i Specify width mm

(When combined with XY091, dimension is inbetween the centre of the main bends)

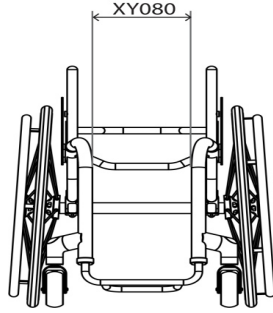

- XY091 Parallel taper design
Parallel taper design

i Specify width mm

(When combined with XY080, dimensions must be smaller by 20mm)

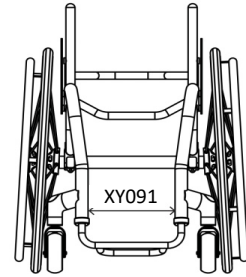

Footrest Design (Choose One)

- XY100 Round design
Round design

Castor Size	Max Height	With XB200
3"	115mm	165mm
4"	125mm	175mm
5"	135mm	185mm

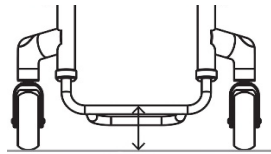

- XY105 Square design
Square design

Castor Size	Max Height	With XB200
3"	135mm	185mm
4"	145mm	195mm
5"	155mm	205mm

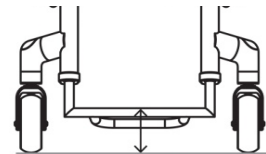

- XB200 High level footrest (Only with XB010, XB080 & XB150)
High level footrest (Only with XB010, XB080 & XB150)
(Max - 100mm)

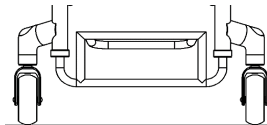

- XB200 High level footrest (Only with XB010, XB080 & XB150)
High level footrest (Only with XB010, XB080 & XB150)
(Max - 100mm)

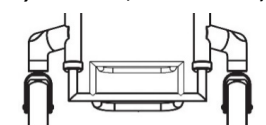

Footrest Individual Measurements

- XY115 Front footrest height
Front footrest height
! mm (Min - 40mm, 60mm for front wheel attachment)
(any footrest over 160mm move to highlevel footrest)

- XY120 Rear footrest height
Rear footrest height
i mm (Std = 20 lower than front height)
(Min - 40mm, 60mm for front wheel attachment)
(any footrest over 160mm move to highlevel footrest)

- XY125 Footrest length
Footrest length
i mm (Std = 100mm)
(160mm and over requires heavy duty upgrade XB150)
(160mm and over requires heavy duty upgrade XB150)

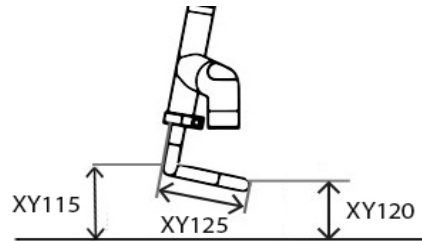

Footrest Style (Choose One)

- XB010 Tubular aluminium footrest
(Height adjustable)

- XB070 Angle adjustable aluminium footrest
(Angle/height adjustable)

- TGAXB080 Tubular footrest welded into frame
(No height adjustment)
Tubular footrest welded into frame

- XB030 Flip up plastic footrest
(Angle/height adjustable, with closed frame only)

- XB150 Heavy duty tubular footrest
(Height adjustable, for Freewheel use)
Heavy duty tubular footrest

Footrest Cover

- XB050 Carbon fibre cover (Not with XB070 & XB030)
Carbon fibre cover (Not with XB070 & XB030)

- XB040 Plastic Cover (Not with XB070 & XB030)
Plastic Cover (Not with XB070 & XB030)

- XB170 Aluminium cover (Not with XB070 & XB030)
Aluminium cover (Not with XB070 & XB030)

- XB165 Rubber grip tape (3M Safety walk) (Not with XB030)
Rubber grip tape (Not with XB030)

Castor Wheels 100mm (4")													
<input type="checkbox"/> XC060	Soft roll 4"x1.3" (Black only) Soft roll 4"x1.3" (Black only)												
<input type="checkbox"/> XC110	Aluminium centre 4"x1" (Silver hub and black urethane tyre only) Aluminium centre 4"x1" (Silver hub and black urethane tyre only)												
<input type="checkbox"/> XC130	Aluminium centre 4"x1.4" (choose colour below) Aluminium centre 4"x1.4" (choose colour below)												
i	<table style="width: 100%; border: none;"> <tr> <td style="width: 33%;"><input type="checkbox"/> Silver hub & black tyre (Std) Silver hub & black tyre</td> <td style="width: 33%;"><input type="checkbox"/> Gold hub & black tyre Gold hub & black tyre</td> <td style="width: 33%;"><input type="checkbox"/> Purple hub & black tyre Purple hub & black tyre</td> </tr> <tr> <td><input type="checkbox"/> Black hub & black tyre Black hub & black tyre</td> <td><input type="checkbox"/> Green hub & black tyre Green hub & black tyre</td> <td></td> </tr> <tr> <td><input type="checkbox"/> Red hub & black tyre Red hub & black tyre</td> <td><input type="checkbox"/> Blue hub & black tyre Blue hub & black tyre</td> <td></td> </tr> </table>	<input type="checkbox"/> Silver hub & black tyre (Std) Silver hub & black tyre	<input type="checkbox"/> Gold hub & black tyre Gold hub & black tyre	<input type="checkbox"/> Purple hub & black tyre Purple hub & black tyre	<input type="checkbox"/> Black hub & black tyre Black hub & black tyre	<input type="checkbox"/> Green hub & black tyre Green hub & black tyre		<input type="checkbox"/> Red hub & black tyre Red hub & black tyre	<input type="checkbox"/> Blue hub & black tyre Blue hub & black tyre				
<input type="checkbox"/> Silver hub & black tyre (Std) Silver hub & black tyre	<input type="checkbox"/> Gold hub & black tyre Gold hub & black tyre	<input type="checkbox"/> Purple hub & black tyre Purple hub & black tyre											
<input type="checkbox"/> Black hub & black tyre Black hub & black tyre	<input type="checkbox"/> Green hub & black tyre Green hub & black tyre												
<input type="checkbox"/> Red hub & black tyre Red hub & black tyre	<input type="checkbox"/> Blue hub & black tyre Blue hub & black tyre												
125mm (5")													
<input type="checkbox"/> XC070	Soft roll 5"x1.3" (Black only) Soft roll 5"x1.3" (Black only)												
<input type="checkbox"/> XC100	Pneumatic Aluminium centre 5"x1" (Grey only) Pneumatic Aluminium centre 5"x1" (Grey only)												
<input type="checkbox"/> XC120	Aluminium centre 5"x1" Aluminium centre 5"x1" (Silver hub and black urethane tyre only) (Silver hub and black urethane tyre only)												
<input type="checkbox"/> XC140	Aluminium centre 5"x1.4" Aluminium centre 5"x1.4" (Silver hub and black urethane tyre only) (Silver hub and black urethane tyre only)												
150mm (6")													
<input type="checkbox"/> XC080	Soft roll 6"x1.3" (Black hub / grey tyre only) Soft roll 6"x1.3" (Black hub / grey tyre only)												
<input type="checkbox"/> XC145	Aluminium centre 6"x1.4" Aluminium centre 6"x1.4" (Silver hub and black urethane tyre only) (Silver hub and black urethane tyre only)												
200mm (8")													
<input type="checkbox"/> XC185	Pneumatic offroad 8"x2" (only with TX Forward castor position) Pneumatic offroad 8"x2" (only with TX Forward castor position)												
Castor Forks													
<input type="checkbox"/> XC190	Performance castor fork Performance castor fork (Std when no option selected) Note: Colour follows accent												
<input type="checkbox"/> XC192	High trail castor fork High trail castor fork Note: Greater distance between contact patch and steering axis reduces flutter at higher speeds. Colour follows accent												
<input type="checkbox"/> XC210	Froglegs suspension castor fork Froglegs suspension castor fork i <input type="checkbox"/> Black <input type="checkbox"/> Silver Black Silver												
Castor Pin Width													
<input checked="" type="checkbox"/> XY330	Castor pin width Castor pin width												
<input type="checkbox"/>	Optimise measurements Optimise measurements												
Wheel Lock Options (choose one)													
<input type="checkbox"/> XD020	Underseat scissor Underseat scissor												
<input type="checkbox"/> XD030	Compact scissor Compact scissor												
<input type="checkbox"/> XD035	Compact scissor with lightweight fixing <i>(Only with fixed centre of gravity)</i> Compact scissor with lightweight fixing <i>(Only with fixed centre of gravity)</i>												
<input type="checkbox"/> XD050	Push to lock Push to lock												
<input type="checkbox"/> XD046	Out Front push to lock Out Front push to lock												
<input type="checkbox"/> XD085	Eagle wheel locks (Indicate colour) Eagle wheel locks (Indicate colour)												
<input type="checkbox"/> XD086	Eagle WL with L/W fixing (Indicate colour) <i>(Only with fixed centre of gravity)</i> Eagle WL with L/W fixing (Indicate colour) <i>(Only with fixed centre of gravity)</i>												
<input type="checkbox"/> XD010	Omit wheel locks Omit wheel locks												
	<table style="display: inline-table; border: none;"> <tr> <td style="text-align: center;"><input type="checkbox"/></td> <td style="text-align: center;"><input type="checkbox"/></td> <td style="text-align: center;"><input type="checkbox"/></td> <td style="text-align: center;"><input type="checkbox"/></td> </tr> <tr> <td style="text-align: center;">BLACK</td> <td style="text-align: center;">PURPLE</td> <td style="text-align: center;">RED</td> <td style="text-align: center;">BLUE</td> </tr> <tr> <td style="text-align: center;">BLACK</td> <td style="text-align: center;">PURPLE</td> <td style="text-align: center;">RED</td> <td style="text-align: center;">BLUE</td> </tr> </table> <p>Black Std if no option selected</p>	<input type="checkbox"/>	<input type="checkbox"/>	<input type="checkbox"/>	<input type="checkbox"/>	BLACK	PURPLE	RED	BLUE	BLACK	PURPLE	RED	BLUE
<input type="checkbox"/>	<input type="checkbox"/>	<input type="checkbox"/>	<input type="checkbox"/>										
BLACK	PURPLE	RED	BLUE										
BLACK	PURPLE	RED	BLUE										

SIDEGUARDS AND ARMRESTS

Sideguard Aluminium Options		Sideguard with Fender Aluminium Options	
<input type="checkbox"/> XE030	Screw on aluminium Screw on aluminium	<input type="checkbox"/> XE040	Screw on aluminium with fender Screw on aluminium with fender
<input type="checkbox"/> XE080	Lift out aluminium Lift out aluminium	<input type="checkbox"/> XE090	Lift out aluminium with fender Lift out aluminium with fender
<input type="checkbox"/> TGAXE130	Fold flat aluminium Fold flat aluminium	<input type="checkbox"/> TGAXE140	Fold flat aluminium with fender Fold flat aluminium with fender
<input type="checkbox"/> XE180	Flip back aluminium Flip back aluminium	<input type="checkbox"/> XE190	Flip back aluminium with fender Flip back aluminium with fender
<input type="checkbox"/> TGAXE220	Welded with 6mm bead Welded with 6mm bead		
<input type="checkbox"/> TGAXE230	Welded aluminium sport <i>(Extra strong)</i> Welded aluminium sport		
Carbon Fibre Options		Carbon Fibre Options	
<input type="checkbox"/> XE050	Screw on carbon fibre Screw on carbon fibre	<input type="checkbox"/> XE060	Screw on carbon fibre with fender Screw on carbon fibre with fender
<input type="checkbox"/> XE100	Lift out carbon fibre Lift out carbon fibre	<input type="checkbox"/> XE110	Lift out carbon fibre with fender Lift out carbon fibre with fender
<input type="checkbox"/> TGAXE150	Fold flat carbon fibre Fold flat carbon fibre	<input type="checkbox"/> TGAXE160	Fold flat carbon fibre with fender Fold flat carbon fibre with fender
<input type="checkbox"/> XE200	Flip back carbon fibre Flip back carbon fibre	<input type="checkbox"/> XE210	Flip back carbon fibre with fender Flip back carbon fibre with fender
ABS Plastic Options		Sideguard Measurements	
<input type="checkbox"/> XE070	Screw on ABS plastic Screw on ABS plastic	Fender Height	
<input type="checkbox"/> XE120	Lift out ABS plastic Lift out ABS plastic	<input type="checkbox"/> 10mm above tyre <i>(Standard)</i> 10mm above tyre (Standard)	
<input type="checkbox"/> TGAXE170	Fold flat ABS plastic Fold flat ABS plastic	<input type="checkbox"/> Individual above tyre Individual above tyre <i>(Min = 10mm)</i>	
		<input type="checkbox"/> <input type="text" value="mm"/>	
Sideguard Measurements		Fender position	
Optimised measurements		<input type="checkbox"/> Centre of tyre <i>(Standard if no option selected)</i> Centre of tyre <i>(Standard if no option selected)</i>	
<input type="checkbox"/> 25mm above tyre <i>(Follow tyre)</i> 25mm above tyre (Follow tyre)		<input type="checkbox"/> Outside of tyre Outside of tyre	
<input type="checkbox"/> <i>(Follow tyre)</i> <input type="text" value="mm"/>			
<input type="checkbox"/> Level with tyre <i>(Follow tyre)</i> Level with tyre <i>(Follow tyre)</i>			
<input type="checkbox"/> Individual measurements			
<input type="checkbox"/> Sideguard length Sideguard length			
<input type="checkbox"/> <input type="text" value="mm"/>			
<input type="checkbox"/> Sideguard height Sideguard height			
<input type="checkbox"/> <input type="text" value="mm"/>			
		Armrest Options	
		<input type="checkbox"/> XF010	Lift out armrest with plastic sideguard <i>(Indicate fixed height)</i> Lift out armrest with plastic sideguard
		<input type="checkbox"/> XF020	Lift out armrest with Aluminium sideguard <i>(Indicate fixed height)</i> Lift out armrest with Aluminium sideguard
		<input type="text" value="mm"/>	<i>Height (Top of seatrail to top of armrest)</i>

BACKREST

Backrest Height

XY230 Fixed height backrest (Max - 400mm)
Fixed height backrest (Max - 400mm)
Specify height

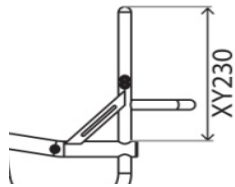

XY245 Adjustable height backrest (+/-25mm) (Max - 400mm)
Adjustable height backrest (Max - 400mm)
Specify height

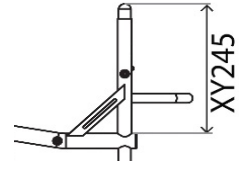

Backrest Design

XG010 Fixed backrest (Non-folding)
Fixed backrest (Non-folding)

TGAXG020 Folding backrest (with 2 position snap lock and angle adjust ± 5 Deg)
Folding backrest (with 2 position snap lock and angle adjust ± 5 Deg)

Ergonomic Options

XY360 Backrest angle
Backrest angle
-5 -3 0 +3 +5
Individual

(Max -10/+20 Deg)

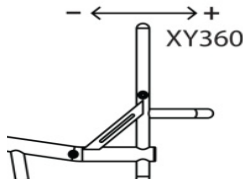

XG100 Ergonomic backrest
Ergonomic backrest
Vertical height
Vertical height

Rearward position
Rearward position

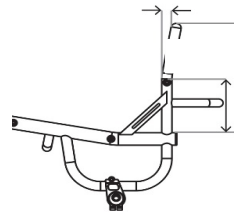

XG110 Inward taper (inside of backrest posts)
Inward taper (inside of backrest posts)
Specify width or per side

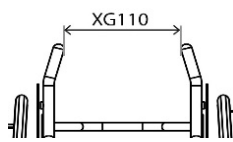

XG120 Outward flare (inside of backrest posts)
Outward flare (inside of backrest posts)
Specify width or per side

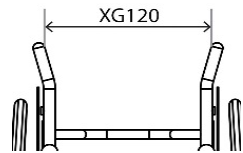

Push handle Options

XG070 Screw in push handles
Screw in push handles

XG080 Flip down push handles (N/A with XY245)
Flip down push handles (N/A with XY245)

XG085 Flip down push handles height adjustable (N/A with XY245)
Flip down push handles height adjustable (N/A with XY245)

XG090 Stroller push handles height adjustable
Stroller push handles height adjustable
Height from floor to top of handles

 Optimise (1000mm from floor) (Quickie design)

XG097 Integrated push handle (N/A with XY245)
Integrated push handle (N/A with XY245) (Quickie design)

Backrest Options

XG040 Heavy duty backrest upgrade (Recommended for hand cycling) (Not with XY245)
Heavy duty backrest upgrade (Recommended for hand cycling) (Not with XY245)

XG130 Extra deep Square brace bar (Recommended for JAY backs) (Std - 90mm)
Extra deep Square brace bar (Recommended for JAY backs) (Std - 90mm)
Depth

ILSA Backrest Options

XG140 Integrated lateral support
Integrated lateral support

A - Left <input type="text" value="mm"/>	A - Right <input type="text" value="mm"/>
B - Left <input type="text" value="mm"/>	B - Right <input type="text" value="mm"/>
C - Left <input type="text" value="mm"/>	C - Right <input type="text" value="mm"/>
D - Left <input type="text" value="mm"/>	D - Right <input type="text" value="mm"/>

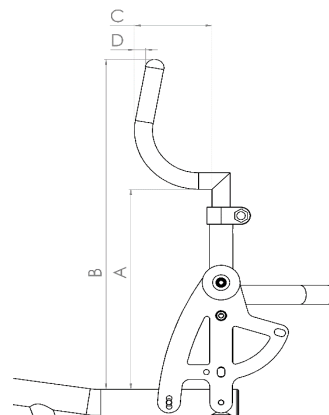

CAMBER BAR

Adjustable Centre of Gravity

XH110 Square back adjustable centre of gravity (25-150mm)
Square back adjustable centre of gravity

Specify measurement mm

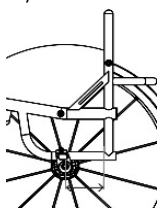

XH120 Round back adjustable centre of gravity (60-150mm)
Round back adjustable centre of gravity

Specify measurement mm

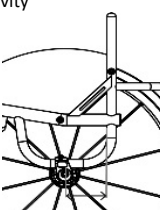

Specify Camber Angle

XY390 Camber angle
Camber angle

0 1 2 3 5

Camber Bar Options

XH040 Handbike camber bar fixed
Handbike camber bar fixed

Camber angle (Handbike camber bar)
Camber angle (Handbike camber bar)
 0 5

Castor height from floor for handbike fitting (Standard 30mm if not indicated)
Castor height from floor for handbike fitting (Standard 30mm if not indicated)
 30 50

XA226 Make Ready for Batec Bloc (Upgraded Camber Bar to suit)
Make Ready for Batec Bloc (Upgraded Camber Bar to suit)

Fixed Centre of Gravity

TGAXH100 Single post fixed centre of gravity (25-125mm)
(Open frame only)
(Not with Crash test option)
Single post fixed centre of gravity (Open frame only)
(Not with Crash test option)
Specify measurement mm

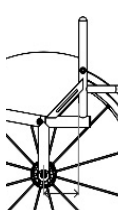

TGAXH090 V-style fixed centre of gravity (25-125mm)
V-style fixed centre of gravity

Specify measurement mm

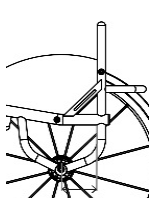

Specify Camber Angle

XY390 Camber angle
Camber angle

0 1 2 3 5

Camber Bar Options

XH040 Handbike camber bar fixed
Handbike camber bar fixed

Camber angle (Handbike camber bar)
Camber angle (Handbike camber bar)
 0 5

Castor height from floor for handbike fitting (Standard 30mm if not indicated)
Castor height from floor for handbike fitting (Standard 30mm if not indicated)
 30 50

XA227 Batec Bloc and Mount
Batec Bloc and Mount

Anti-Tip Options

XJ010 Swingaway anti tip LEFT side (Only with square back frame. Not with XH040)
Swingaway anti tip LEFT side (Only with square back frame. Not with XH040)

XJ020 Swingaway anti tip RIGHT side (Only with square back frame. Not with XH040)
Swingaway anti tip RIGHT side (Only with square back frame. Not with XH040)

XJ100 Single sport anti tip (centre mounted)
Single sport anti tip (centre mounted)

REAR WHEELS			
Rear Wheel Size			
<input type="checkbox"/> XY420	24" Wheels <i>24" Wheels</i>	<input type="checkbox"/> XY430	25" Wheels <i>25" Wheels</i>
<input type="checkbox"/> XY440	26" Wheels <i>26" Wheels</i>		
Rear Wheel Gap			
<input checked="" type="checkbox"/> XY460	Rear wheel gap <i>Rear wheel gap</i>		
<input type="checkbox"/> 15	<input type="checkbox"/> 20	<input type="checkbox"/> 25	Individual <input style="width: 100px;" type="text"/> mm
Rear Wheel Options			
<input type="checkbox"/> XK010	Fusion 16 spoke <i>Fusion 16 spoke</i>	(Silver Hub, black spokes) <i>(Silver Hub, black spokes)</i>	<input type="checkbox"/> XK320
<input type="checkbox"/> XK050	Spinergy LX 12 spoke <i>Spinergy LX 12 spoke</i>		Spinergy XLX 12 spoke <i>Spinergy XLX 12 spoke</i>
<input type="checkbox"/> XK150	Spinergy CLX 18 carbon blade spoke <i>Spinergy CLX 18 carbon blade spoke</i>	<i>N/A IN SILVER HUB</i> <i>N/A IN SILVER HUB</i>	<input type="checkbox"/> XK070
<input type="checkbox"/> XK080	Spinergy SLX 24 spoke <i>Spinergy SLX 24 spoke</i>		Spinergy BLXL 18 blade spoke <i>Spinergy BLXL 18 blade spoke</i>
Spinergy Colour Options:			
<input type="checkbox"/> Black spokes <i>Black spokes</i>	<input type="checkbox"/> White spokes <i>White spokes</i>	<input type="checkbox"/> Yellow spokes <i>Yellow spokes</i>	<input type="checkbox"/> XK180
<input type="checkbox"/> Red spokes <i>Red spokes</i>	<input type="checkbox"/> Blue spokes <i>Blue spokes</i>	<input type="checkbox"/> Pink spokes <i>Pink spokes</i>	Individual spoke design <i>Individual spoke design</i>
<input type="checkbox"/> Purple spokes <i>Purple spokes</i>	<input type="checkbox"/> Orange spokes <i>Orange spokes</i>	<input type="checkbox"/> Green spokes <i>Green spokes</i>	<i>(Specify colour)</i>
Spinergy Anodise Options			
<input type="checkbox"/> XK190	Black hub <i>(std option)</i> <i>Black hub</i>	<input type="checkbox"/> XK200	Silver hub <i>(N/A with BLXL/CLX)</i> <i>Silver hub</i>
<input type="checkbox"/> XK202	Purple hub/rims <i>(LX, XLX & BLXL only)</i> <i>Purple hub/rims</i>	<input type="checkbox"/> XK203	Blue hub/rims <i>(LX, XLX & BLXL only)</i> <i>Blue hub/rims</i>
<input type="checkbox"/> XK201	Red hub/rims <i>(LX, XLX & BLXL only)</i> <i>Red hub/rims</i>	<input type="checkbox"/> XK204	Gold hub/rims <i>(LX, XLX & BLXL only)</i> <i>Gold hub/rims</i>
Supply Without Wheels			
<input type="checkbox"/> XK040	Supply without Wheels and Axle Pins <i>Supply without Wheels and Axle Pins</i>		<input style="width: 150px;" type="text"/> <i>Wheel Type:</i> <input style="width: 150px;" type="text"/> <i>Tyre Type:</i>
Handrim Position / Options			
<input type="checkbox"/> XY480	Narrow set handrim <i>Narrow set handrim</i>	<input type="checkbox"/> XY485	Wide set handrim <i>Wide set handrim</i>
<input type="checkbox"/> XL090	Remove excess mounting tabs <i>Remove excess mounting tabs</i>	<i>(recommended for small wheel gaps)</i> <i>(recommended for small wheel gaps)</i>	
Handrim Styles			
<input type="checkbox"/> XL010	Aluminium hard anodised 6 tab <i>Aluminium hard anodised 6 tab</i>	<input type="checkbox"/> XL040	Titanium 6 tab <i>Titanium 6 tab</i>
<input type="checkbox"/> XL160	Elipse 6 tab <i>Elipse 6 tab</i>	<input type="checkbox"/> XL035	Natural Fit LT <i>Natural Fit LT</i>
<input type="checkbox"/> XL020	Tetra grip 6 tab <i>Tetra grip 6 tab</i>	<input type="checkbox"/> XL150	Carbolife Gekko <i>Carbolife Gekko</i>
<input type="checkbox"/> XL100	Para grip 6 tab <i>Para grip 6 tab</i>	<input type="checkbox"/> XL170	Carbolife Curve L (Black) <i>Carbolife Curve L (Black)</i>
Tyre Options			
<input type="checkbox"/> XM010	Kenda (Std) <i>Kenda</i>	<input type="checkbox"/> Grey <i>Grey</i>	<input type="checkbox"/> Blue <i>Blue</i>
<input type="checkbox"/> XM130	Kenda black <i>Kenda black</i>	<input type="checkbox"/> Red <i>Red</i>	<input type="checkbox"/> XM060
<input type="checkbox"/> XM020	Schwalbe Marathon Plus <i>Schwalbe Marathon Plus</i>		Schwalbe One <i>Schwalbe One</i>
<input type="checkbox"/> XM040	Shox solid airless, black (not with fusion wheels) <i>Shox solid airless, black (not with fusion wheels)</i>		Kenda K885 mountain bike tyre <i>Kenda K885 mountain bike tyre</i>
Inner Tube Valve Options			
<input type="checkbox"/> XY500	Schraeder inner tube valve <i>(Standard if no option selected)</i> <i>Schraeder inner tube valve</i>		<input type="checkbox"/> XY490
			Presta inner tube valve <i>Presta inner tube valve</i>
Wheel Accessories			
<input type="checkbox"/> XK220	Titanium 130mm quick release axle pins (pair) <i>(N/A with XK010 & XK070)</i> <i>Titanium 130mm quick release axle pins (pair)</i>	<input type="checkbox"/> XK300	Offroad wheel set 22" with handrim, MTB tyre and axle pins <i>(Replaces 24" and 25" wheel with XM010)</i> <i>Offroad wheel set 22" with handrim, MTB tyre and axle pins (Replaces 24" and 25" wheel with XM010)</i>
<input type="checkbox"/> XK240	Quad release axle nuts (pair) <i>Quad release axle nuts (pair)</i>	<input type="checkbox"/> XK310	Offroad wheel set 24" with handrim, MTB tyre and axle pins <i>(Replaces 26" wheel with XM010)</i> <i>Offroad wheel set 24" with handrim, MTB tyre and axle pins (Replaces 26" wheel with XM010)</i>
<input type="checkbox"/> XK145	Black Gloss Spokeguards <i>Black Gloss Spokeguards</i>	<input type="checkbox"/> fitted <i>fitted</i>	<input type="checkbox"/> not fitted <i>not fitted</i>

FINISH OPTIONS			
Frame & Component Finish			
<input type="checkbox"/> XN010	Powder coated frame Powder coated frame	<input type="checkbox"/> XN150	Powder coated components (Frame colour if not specified) Powder coated components (Frame colour if not specified)
Frame Comp.	<u>Gloss</u>	Frame Comp.	<u>Matt</u> <u>Special</u>
<input type="checkbox"/> <input type="checkbox"/>	Black gloss 103	<input type="checkbox"/> <input type="checkbox"/>	Black matt 105
<input type="checkbox"/> <input type="checkbox"/>	White gloss 100	<input type="checkbox"/> <input type="checkbox"/>	White matt 101
<input type="checkbox"/> <input type="checkbox"/>	Grey gloss 132	<input type="checkbox"/> <input type="checkbox"/>	Grey matt 131
<input type="checkbox"/> <input type="checkbox"/>	Cream gloss 135	<input type="checkbox"/> <input type="checkbox"/>	Light grey matt 133
<input type="checkbox"/> <input type="checkbox"/>	Red gloss 108	<input type="checkbox"/> <input type="checkbox"/>	Navy blue matt 152
<input type="checkbox"/> <input type="checkbox"/>	Yellow gloss 120	<input type="checkbox"/> <input type="checkbox"/>	Chrome Mirror 300
<input type="checkbox"/> <input type="checkbox"/>	Forest green gloss 143	<input type="checkbox"/> <input type="checkbox"/>	Sparkle silver 170
<input type="checkbox"/> <input type="checkbox"/>	Green gloss 107	<input type="checkbox"/> <input type="checkbox"/>	Metallic black matt 104
<input type="checkbox"/> <input type="checkbox"/>	Dark blue gloss 151	<input type="checkbox"/> <input type="checkbox"/>	Metallic grey matt 130
<input type="checkbox"/> <input type="checkbox"/>	Royal blue gloss 154	<input type="checkbox"/> <input type="checkbox"/>	Black sandpaper 201
<input type="checkbox"/> <input type="checkbox"/>	Blue gloss 174	<input type="checkbox"/> <input type="checkbox"/>	Grey sandpaper 202
<input type="checkbox"/> <input type="checkbox"/>	Duckegg blue gloss 141	<input type="checkbox"/> <input type="checkbox"/>	White sandpaper 200
<input type="checkbox"/> <input type="checkbox"/>	Pink gloss 188		
<input type="checkbox"/> <input type="checkbox"/>	Orange gloss 180		
<input type="checkbox"/> <input type="checkbox"/>	Purple gloss 157		
<input type="checkbox"/> TGAXN030	Brushed frame (All parts black unless XN160 chosen)	<input type="checkbox"/> XN160	Brushed components Brushed components
<input type="checkbox"/> TGAXN050	Polished frame (All parts black unless XN170 chosen)	<input type="checkbox"/> XN170	Polished components Polished components
<p>Note: Accent colour includes, forks, clamps & castor caps.</p>			
<input type="checkbox"/>	Black accent	<input type="checkbox"/>	Silver accent
<input type="checkbox"/>	Red accent	<input type="checkbox"/>	Blue accent
<input type="checkbox"/>	Purple accent	<input type="checkbox"/>	Carbon accent (Castor caps only, black for rest)
	Black accent	<input type="checkbox"/>	Carbon accent (Castor caps only, black for rest)
	Red accent		
	Red accent		
	Purple accent		
	Purple accent		
UPHOLSTERY			
Seat Upholstery			
<input type="checkbox"/> XP040	Seat sling adjustable tension with straps Seat sling adjustable tension with straps	<input type="checkbox"/> XR050	Carbon fibre seat plate Carbon fibre seat plate
			mm (STD XY020 - 20mm)
Backrest Upholstery			
<input type="checkbox"/> XP050	Airtech backrest strap adjustable Airtech backrest strap adjustable	<input type="checkbox"/> XP070	Backrest upgrade to leather corners (Black) Backrest upgrade to leather corners (Black)
Backrest Stitching Colour			
<input type="checkbox"/>	Silver	<input type="checkbox"/>	Black
<input type="checkbox"/>	Red	<input type="checkbox"/>	Orange
<input type="checkbox"/>	Red	<input type="checkbox"/>	Blue
		<input type="checkbox"/>	Purple
		<input type="checkbox"/>	Purple
			Individual: _____
			Individual: _____
RGK Logo Colour			
<input type="checkbox"/>	White (Std)	<input type="checkbox"/>	Green
<input type="checkbox"/>	Red	<input type="checkbox"/>	Orange
<input type="checkbox"/>	Red	<input type="checkbox"/>	Blue
		<input type="checkbox"/>	Purple
		<input type="checkbox"/>	Purple
			Individual: _____
			Individual: _____
Model Logo Colour			
<input type="checkbox"/>	White (Std)	<input type="checkbox"/>	Green
<input type="checkbox"/>	Red	<input type="checkbox"/>	Orange
<input type="checkbox"/>	Red	<input type="checkbox"/>	Blue
		<input type="checkbox"/>	Purple
		<input type="checkbox"/>	Purple
			Individual: _____
			Individual: _____
Backrest Accessories			
<input type="checkbox"/> XP110	Backrest with zip pocket Backrest with zip pocket	<input type="checkbox"/> XP170	Individual backrest embroidery Individual backrest embroidery
			Complete page 11

CUSHION			
Cushion foam options			
<input type="checkbox"/>	XP080	Cushion foam <i>(select density and size below)</i> Cushion foam <i>(select density and size below)</i>	
<input type="checkbox"/>	<input type="checkbox"/>	Soft (CMS040) Soft (CMS040) 50mm 50mm	<input type="checkbox"/>
<input type="checkbox"/>	<input type="checkbox"/>	Medium (CMS050) Medium (CMS050) 75mm 75mm	<input type="checkbox"/>
<input type="checkbox"/>	<input type="checkbox"/>		100mm 100mm
Cushion Cover Upgrades			
<input type="checkbox"/>	XP085	Nylon cushion cover <i>(Black)</i> Nylon cushion cover <i>(Black)</i>	
<input type="checkbox"/>	XP090	Air Lite cushion cover <i>(Black)</i> Air Lite cushion cover <i>(Black)</i>	
<input type="checkbox"/>	XP100	Leather cushion cover <i>(Black)</i> Leather cushion cover <i>(Black)</i>	
Jay Products - PLEASE PROVIDE JAY ORDER FORM			
<input type="checkbox"/>	JAY Cushion <i>(Price dependant on size / option)</i> JAY Cushion <i>(Price dependant on size / option)</i>	<input type="checkbox"/>	Jay Order form attached Jay Order form attached
<input type="checkbox"/>	JAY Whitmyer Headrest <i>(Price dependant on size / option)</i> JAY Whitmyer Headrest <i>(Price dependant on size / option)</i>	<input type="checkbox"/>	Jay Order form attached Jay Order form attached
FRAME OPTIONS			
<input type="checkbox"/>	XR060	Welded calf strap mounting loops <i>(To locate calf strap on front frame)</i> Welded calf strap mounting loops <i>(To locate calf strap on front frame)</i> Specify height from floor <input type="text"/>	
<input type="checkbox"/>	Optimise measurements Optimise measurements		
ACCESSORIES			
<input type="checkbox"/>	XR080	Frontwheel assembly <i>(Only with tubular and angle adjustable footrest)</i> Frontwheel assembly <i>(Only with tubular and angle adjustable footrest)</i>	<input type="checkbox"/> red <input type="checkbox"/> purple <input type="checkbox"/> blue <input type="checkbox"/> silver
<input type="checkbox"/>	XP120	Frame protectors Neoprene zip fasten <i>(Black)</i> Frame protectors Neoprene zip fasten <i>(Black)</i>	
<input type="checkbox"/>	XP420	Frame protectors Nylon velcro fasten <i>(Black)</i> Frame protectors Nylon velcro fasten <i>(Black)</i>	
<input type="checkbox"/>	XR010	Seat pouch velcro attach <i>(Black)</i> Seat pouch velcro attach <i>(Black)</i>	
<input type="checkbox"/>	XR200	Rucksack with RGK logo <i>(Black)</i> Rucksack with RGK logo <i>(Black)</i>	
<input checked="" type="checkbox"/>	XR090	Tool kit Tool kit	
<input checked="" type="checkbox"/>	XS060	Calf strap Calf strap	

SERIAL NO: _____

ADDITIONAL NOTES

INDIVIDUAL BACKREST EMBROIDERY

PLEASE PROVIDE JPEG IMAGE AT TIME OF ORDER AND NOTE POSITION BELOW



BRACE BAR

SPEC NOTES:

OFF SPEC REQUEST* *(please specify below the page number(s) and details to which the off spec request applies.)*

OFF SPEC REQUEST APPROVED *(for internal RGK office only)*

X
RGK Internal Sign-off

Off spec requests require a feasibility study which may increase order price and lead time. Any dimension/ option/ frame request not listed on the order form will be treated as an off spec request.*