

AI
ALUMINIUM 7020



Customer Contact Details

Customer Name: _____

Advisor: _____

Address: _____

Phone: _____

Email: _____

Ship to Customer Address:

Shipping Name: _____

Shipping Address: _____

Phone: _____

Email: _____

Additional Information

Notes: _____

Current Wheelchair: _____

Customer Weight: _____

Customer Height: _____

Customer Disability: _____

Other

Guide:

- Base product
- Required option
- Optional Extra
- Critical Information
- Information Needed

PRODUCT STYLE

FXAXZ010 TIGA FX
TIGA FX

XA070 Open design
Open design

Max User Weight 110kg (241lbs)

PLEASE NOTE: ALL RGK CHAIRS ARE HAND BUILT AND HAVE A MANUFACTURING MEASUREMENT TOLERANCE OF +/- 5MM

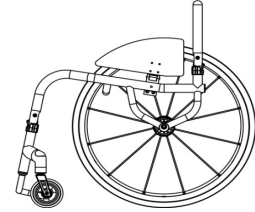

CAD APPROVAL

- XW009 QUOTE ONLY (NO CAD FOR APPROVAL)
QUOTE ONLY (NO CAD FOR APPROVAL)
- XW011 ORDER (NO CAD FOR APPROVAL)
ORDER (NO CAD FOR APPROVAL)
- XW012 QUOTE CAD drawing for approval (2 amendments ONLY)
QUOTE CAD drawing for approval
- XW010 ORDER CAD drawing for approval (2 amendments ONLY)
ORDER CAD drawing for approval

KEY MEASUREMENTS

- XY010 Seat width (Inside to inside of sideguards)
Seat width
 (Max - 460mm)
(Min - 250mm)
- XY020 Seat length
Seat length
 (Max - 460mm)
(Min - 250mm)
- XY030 Extra seat length (Provides additional leg support & hand grip)
Extra seat length
- XY050 Front frame height
Front frame height
 (Max - 550mm)
(Min - 480mm)
- XY060 Rear frame height
Rear frame height
 (Max - 550mm)
(Min - 360mm)
- XY070 Frame length
Frame length
 (Max 625mm)
(Min XY020 + XY030 + 140mm)
- XY072 Castor position
Castor position

 Optimise measurements
Optimise measurements
- XA020 Ergonomic seat
Ergonomic seat
Specify length
 (Standard = 120mm)

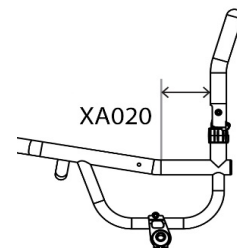
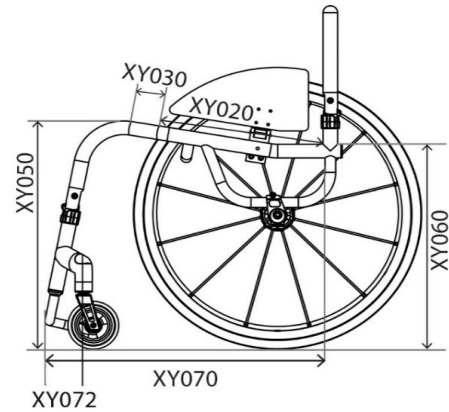
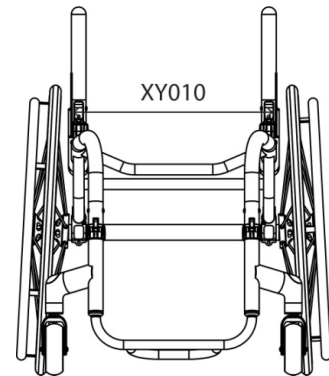

FRONT FRAME AND FOOTREST

Front Frame Options

XY080 Seat taper design
Seat taper design
 Specify width
 mm

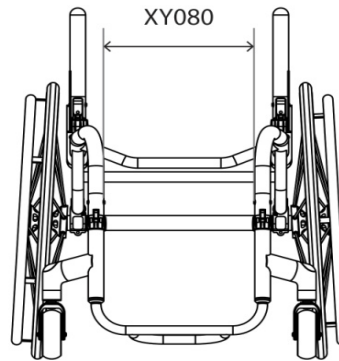

Optimise measurements (XY010 - 100mm)
Optimise measurements (XY010 - 100mm)

Footrest Design (Choose One)

XY100 Round design
Round design

Castor Size	Max Height	With XB200
3"	115mm	165mm
4"	125mm	175mm
5"	135mm	185mm

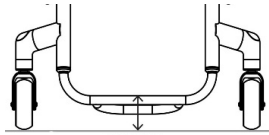

XY105 Square design
Square design

Castor Size	Max Height	With XB200
3"	135mm	185mm
4"	145mm	195mm
5"	155mm	205mm

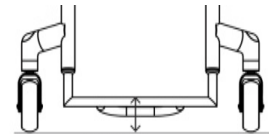

XB200 High level footrest (Only with XB010, XB080 & XB150)
High level footrest (Only with XB010, XB080 & XB150)
 (Max - 100mm)

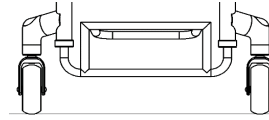

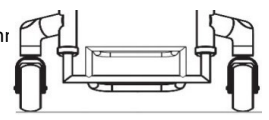

XB200 High level footrest (Only with XB010, XB080 & XB150)
High level footrest (Only with XB010, XB080 & XB150)
 (Max - 100mm)



Footrest Individual Measurements

XY115 Front footrest height
Front footrest height
 mm (Min - 50mm, 70mm for front wheel attachment)
 (any footrest over 160mm move to highlevel footrest)

XY120 Rear footrest height
Rear footrest height
 mm (Std = 20 lower than front height)
 (Min - 50mm, 70mm for front wheel attachment)
 (any footrest over 160mm move to highlevel footrest)

XY125 Footrest length
Footrest length
 mm (Std = 100mm)
 (160mm and over requires heavy duty upgrade XB150)
(160mm and over requires heavy duty upgrade XB150)

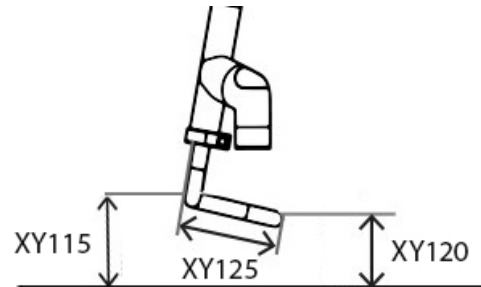

Footrest Style and Cover

FXAXB080 Tubular footrest welded w/ Aluminium plate
 (Supplied with spacer for +20mm adjustment)
Tubular footrest welded w/ Aluminium plate
 (Supplied with spacer for +20mm adjustment)

FXAXB110 Tubular footrest welded w/ Carbon Fibre plate
 (Supplied with spacer for +20mm adjustment)
Tubular footrest welded w/ Carbon Fibre plate
 (Supplied with spacer for +20mm adjustment)

FXAXB120 Clamp-on aluminium plate footrest
 (Angle/height adjustable)
Clamp-on aluminium plate footrest
 (Angle/height adjustable)

Footrest Options

XB165 Rubber grip tape (3M safety walk)
Rubber grip tape (3M safety walk)

CASTOR WHEELS, FORKS & WHEEL LOCKS			
Castor Wheels			
100mm (4")			
<input type="checkbox"/>	XC060	Soft roll 4"x1.3" <i>Soft roll 4"x1.3"</i>	<i>(Black only)</i> <i>(Black only)</i>
<input type="checkbox"/>	XC110	Aluminium centre 4"x1" <i>Aluminium centre 4"x1"</i>	<i>(Silver hub and black urethane tyre only)</i> <i>(Silver hub and black urethane tyre only)</i>
<input type="checkbox"/>	XC130	Aluminium centre 4"x1.4" <i>Aluminium centre 4"x1.4"</i>	<i>(choose colour below)</i> <i>(choose colour below)</i>
<div style="display: flex; justify-content: space-between;"> <div style="width: 30%;"> <p>i <input type="checkbox"/> Silver hub & black tyre <i>Silver hub & black tyre</i></p> <p><input type="checkbox"/> Black hub & black tyre <i>Black hub & black tyre</i></p> <p><input type="checkbox"/> Red hub & black tyre <i>Red hub & black tyre</i></p> </div> <div style="width: 30%;"> <p><input type="checkbox"/> Gold hub & black tyre <i>Gold hub & black tyre</i></p> <p><input type="checkbox"/> Green hub & black tyre <i>Green hub & black tyre</i></p> <p><input type="checkbox"/> Blue hub & black tyre <i>Blue hub & black tyre</i></p> </div> <div style="width: 30%;"> <p><input type="checkbox"/> Purple hub & black tyre <i>Purple hub & black tyre</i></p> </div> </div>			
125mm (5")			
<input type="checkbox"/>	XC070	Soft roll 5"x1.3" <i>Soft roll 5"x1.3"</i>	<i>(Black only)</i> <i>(Black only)</i>
<input type="checkbox"/>	XC100	Pneumatic Aluminium centre 5"x1" <i>Pneumatic Aluminium centre 5"x1"</i>	<i>(Grey only)</i> <i>(Grey only)</i>
<input type="checkbox"/>	XC120	Aluminium centre 5"x1" <i>Aluminium centre 5"x1"</i>	<i>(Silver hub and black urethane tyre only)</i> <i>(Silver hub and black urethane tyre only)</i>
<input type="checkbox"/>	XC140	Aluminium centre 5"x1.4" <i>Aluminium centre 5"x1.4"</i>	<i>(Silver hub and black urethane tyre only)</i> <i>(Silver hub and black urethane tyre only)</i>
150mm (6")			
<input type="checkbox"/>	XC080	Soft roll 6"x1.3" <i>Soft roll 6"x1.3"</i>	<i>(Black hub / Grey tyre only)</i> <i>(Black hub / Grey tyre only)</i>
<input type="checkbox"/>	XC145	Aluminium centre 6"x1.4" <i>Aluminium centre 6"x1.4"</i>	<i>(Silver hub and black urethane tyre only)</i> <i>(Silver hub and black urethane tyre only)</i>
Castor Forks			
<input type="checkbox"/>	XC190	Performance castor fork <i>Performance castor fork</i>	<i>(Std when no option selected)</i> <i>(Std when no option selected)</i>
<input type="checkbox"/>	XC192	High trail castor fork <i>High trail castor fork</i>	<i>Note: Greater distance between contact patch and steering axis reduces flutter at higher speeds. Colour follows accent</i>
<input type="checkbox"/>	XC210	Froglegs suspension castor fork <i>Froglegs suspension castor fork</i>	i <input type="checkbox"/> Black <input type="checkbox"/> Silver <i>Black Silver</i>
Castor Pin Width			
<input checked="" type="checkbox"/>	XY330	Castor pin width <i>Castor pin width</i>	(XY010 plus 70mm) <i>(XY010 plus 70mm)</i>
Wheel Lock Options (Choose one)			
<input type="checkbox"/>	XD020	Underseat Scissor <i>Underseat Scissor</i>	<input type="checkbox"/> XD050 Push to lock <i>Push to lock</i>
<input type="checkbox"/>	XD030	Compact scissor <i>Compact scissor</i>	<input type="checkbox"/> XD046 Out Front push to lock <i>Out Front push to lock</i>
<input type="checkbox"/>	XD035	Compact scissor with lightweight fixing <i>(Only with fixed centre of gravity)</i> <i>Compact scissor with lightweight fixing</i> <i>(Only with fixed centre of gravity)</i>	<input type="checkbox"/> XD085 Eagle wheel locks (Indicate colour) <i>Eagle wheel locks (Indicate colour)</i>
<input type="checkbox"/>	XD010	Omit wheel locks <i>Omit wheel locks</i>	<input type="checkbox"/> XD086 Eagle WL with L/W fixing (Indicate colour) <i>(Only with fixed centre of gravity)</i> <i>Eagle WL with L/W fixing (Indicate colour)</i> <i>(Only with fixed centre of gravity)</i>
<div style="display: flex; justify-content: center; gap: 20px;"> <div style="text-align: center;"><input type="checkbox"/> BLACK <i>BLACK</i></div> <div style="text-align: center;"><input type="checkbox"/> PURPLE <i>PURPLE</i></div> <div style="text-align: center;"><input type="checkbox"/> RED <i>RED</i></div> <div style="text-align: center;"><input type="checkbox"/> BLUE <i>BLUE</i></div> </div> <p style="text-align: center;">Black Std if no option selected</p>			

SIDEGUARDS AND ARMRESTS	
<div style="background-color: #eee; padding: 2px; text-align: center; font-weight: bold; margin-bottom: 5px;">Sideguard</div> <div style="background-color: #eee; padding: 2px; text-align: center; font-weight: bold; margin-bottom: 5px;">Aluminium Options</div> <p><input type="checkbox"/> XE080 Lift out aluminium Lift out aluminium</p> <p><input type="checkbox"/> FXAXE130 Fold flat aluminium Fold flat aluminium</p> <div style="background-color: #eee; padding: 2px; text-align: center; font-weight: bold; margin-bottom: 5px;">Carbon Fibre Options</div> <p><input type="checkbox"/> XE100 Lift out carbon fibre Lift out carbon fibre</p> <p><input type="checkbox"/> FXAXE150 Fold flat carbon fibre Fold flat carbon fibre</p> <div style="background-color: #eee; padding: 2px; text-align: center; font-weight: bold; margin-bottom: 5px;">ABS Plastic Options</div> <p><input type="checkbox"/> XE120 Lift out ABS plastic Lift out ABS plastic</p> <p><input type="checkbox"/> FXAXE170 Fold flat ABS plastic Fold flat ABS plastic</p> <div style="background-color: #eee; padding: 2px; text-align: center; font-weight: bold; margin-bottom: 5px;">Sideguard Measurements</div> <div style="background-color: #eee; padding: 2px; text-align: center; font-weight: bold; margin-bottom: 5px;">Optimised measurements</div> <p><input type="checkbox"/> 25mm above tyre <i>(Follow tyre)</i> 25mm above tyre <i>(Follow tyre)</i></p> <p><input type="checkbox"/> Individual above tyre <i>(Follow tyre)</i> Individual above tyre <i>(Follow tyre)</i></p> <p><input type="checkbox"/> <input style="width: 60px; height: 15px; border: 1px solid black;" type="text"/> mm</p> <p><input type="checkbox"/> Level with tyre <i>(Follow tyre)</i> Level with tyre <i>(Follow tyre)</i></p> <div style="background-color: #eee; padding: 2px; text-align: center; font-weight: bold; margin-bottom: 5px;">Individual measurements</div> <p><input type="checkbox"/> Sideguard length Sideguard length</p> <p><input type="checkbox"/> <input style="width: 60px; height: 15px; border: 1px solid black;" type="text"/> mm</p> <p><input type="checkbox"/> Sideguard height Sideguard height</p> <p><input type="checkbox"/> <input style="width: 60px; height: 15px; border: 1px solid black;" type="text"/> mm</p>	<div style="background-color: #eee; padding: 2px; text-align: center; font-weight: bold; margin-bottom: 5px;">Sideguard with Fender</div> <div style="background-color: #eee; padding: 2px; text-align: center; font-weight: bold; margin-bottom: 5px;">Aluminium Options</div> <p><input type="checkbox"/> XE090 Lift out aluminium with fender Lift out aluminium with fender</p> <p><input type="checkbox"/> FXAXE140 Fold flat aluminium with fender Fold flat aluminium with fender</p> <div style="background-color: #eee; padding: 2px; text-align: center; font-weight: bold; margin-bottom: 5px;">Carbon Fibre Options</div> <p><input type="checkbox"/> XE110 Lift out carbon fibre with fender Lift out carbon fibre with fender</p> <p><input type="checkbox"/> FXAXE160 Fold flat carbon fibre with fender Fold flat carbon fibre with fender</p> <div style="background-color: #eee; padding: 2px; text-align: center; font-weight: bold; margin-bottom: 5px;">Sideguard Measurements</div> <div style="background-color: #eee; padding: 2px; text-align: center; font-weight: bold; margin-bottom: 5px;">Fender height</div> <p><input type="checkbox"/> 10mm above tyre <i>(Standard)</i> 10mm above tyre <i>(Standard)</i></p> <p><input type="checkbox"/> Individual above tyre Individual above tyre <i>(Min = 10mm)</i></p> <p><input type="checkbox"/> <input style="width: 60px; height: 15px; border: 1px solid black;" type="text"/> mm</p> <div style="background-color: #eee; padding: 2px; text-align: center; font-weight: bold; margin-bottom: 5px;">Fender position</div> <p><input type="checkbox"/> Centre of tyre <i>(Standard if no option selected)</i> Centre of tyre <i>(Standard if no option selected)</i></p> <p><input type="checkbox"/> Outside of tyre Outside of tyre</p> <div style="background-color: #eee; padding: 2px; text-align: center; font-weight: bold; margin-bottom: 5px;">Armrest Options</div> <p><input type="checkbox"/> XF010 Lift out armrest with plastic sideguard <i>(Indicate fixed height)</i> Lift out armrest with plastic sideguard <i>(Indicate fixed height)</i></p> <p><input type="checkbox"/> XF020 Lift out armrest with Aluminium sideguard <i>(Indicate fixed height)</i> Lift out armrest with Aluminium sideguard <i>(Indicate fixed height)</i></p> <p><i>Height (Top of seatrail to top of armrest)</i> Height (Top of seatrail to top of armrest)</p> <p><input type="checkbox"/> <input style="width: 60px; height: 15px; border: 1px solid black;" type="text"/> mm</p>

BACKREST

Backrest Height

- XY230 Fixed height backrest
(Max - 400mm)
Fixed height backrest
(Max - 400mm)

Specify height

mm

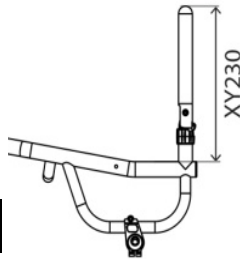

- XY245 Adjustable height backrest
(Max - 400mm)
(+/-25mm)
Adjustable height backrest
(Max - 400mm)

Specify height

mm

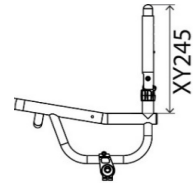

Backrest Design

- FXAXG060 Folding backrest with Q Lock (Black)
Folding backrest with Q Lock (Black)

Ergonomic Options

- XY360 Backrest angle
Backrest angle
- 5 -3 0 +3 +5
- Individual Deg
(Max -7/+7 Deg)

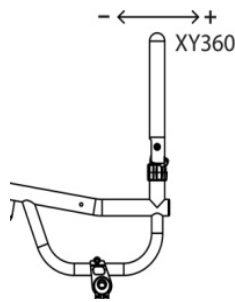

- XG100 Ergonomic backrest
Ergonomic backrest
Vertical height
Vertical height

mm

Rearward position
Rearward position

mm

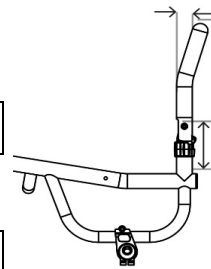

- XG110 Inward taper
(inside of backrest posts)
Inward taper
(inside of backrest posts)
Specify width or per side

mm

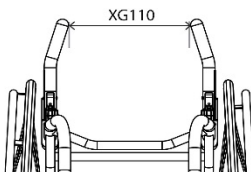

- XG120 Outward flare
(inside of backrest posts)
Outward flare
(inside of backrest posts)
Specify width or per side

mm

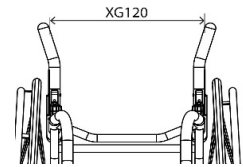

Push handle Options

- XG070 Screw in push handles
Screw in push handles
- XG080 Flip down push handles (N/A with XY245)
Flip down push handles (N/A with XY245)
- XG085 Flip down push handles height adjustable (N/A with XY245)
Flip down push handles height adjustable (N/A with XY245)
- XG097 Integrated push handle (Quickie design) (N/A with XY245)
Integrated push handle (Quickie design) (N/A with XY245)

CAMBER BAR

Adjustable Centre of Gravity

- XH110 Square back adjustable centre of gravity
Square back adjustable centre of gravity

(25-150mm)
(Max seat width 500mm)

Specify measurement

mm

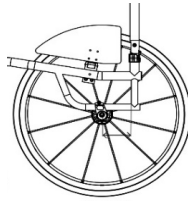

XH110

- XH120 Round back adjustable centre of gravity
Round back adjustable centre of gravity

(60-150mm)

Specify measurement

mm

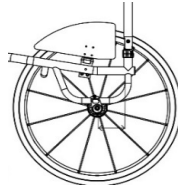

XH120

Fixed Centre of Gravity

- FXAXH090 V-style fixed centre of gravity
V-style fixed centre of gravity

(25-125mm)

Specify measurement

mm

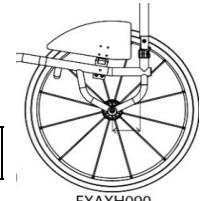

FXAXH090

Specify Camber Angle

- XY390 Camber angle
Camber angle
- 0 1 2 3 5

Specify Camber Angle

- XY390 Camber angle
Camber angle
- 0 1 2 3 5

Camber Bar Options

- FXAXK227 Standard Axle pin (120 or 130mm)
Standard Axle pin (120 or 130mm)

- XK220 Titanium 130mm quick release axle pins (pair)
(N/A with XK010, XK070 or FXAXK226)
Titanium 130mm quick release axle pins (pair)
(N/A with XK010, XK070 or FXAXK226)

- FXAXK226 100mm Titanium Axle pin (Fixed Axle Only)
100mm Titanium Axle pin (Fixed Axle Only)

- XK240 Quad release axle nuts (pair)
(N/A with FXAXK226)
Quad release axle nuts (pair)
(N/A with FXAXK226)

- XA226 Make Ready for Batec Bloc (Upgraded Camber Bar to suit)
Make Ready for Batec Bloc (Upgraded Camber Bar to suit)

- XA227 Batec Bloc and Mount
Batec Bloc and Mount

Anti-Tip Options

- XJ010 Swingaway anti tip LEFT side (Only with square back frame. Not with XH040)
Swingaway anti tip LEFT side (Only with square back frame. Not with XH040)

- XJ100 Single sport anti tip (centre mounted)
Single sport anti tip (centre mounted)

- XJ020 Swingaway anti tip RIGHT side (Only with square back frame. Not with XH040)
Swingaway anti tip RIGHT side (Only with square back frame. Not with XH040)

REAR WHEELS			
Rear Wheel Size			
<input type="checkbox"/> XY420	24" Wheels <i>24" Wheels</i>	<input type="checkbox"/> XY430	25" Wheels <i>25" Wheels</i>
Rear Wheel Gap			
<input checked="" type="checkbox"/> XY460	Rear wheel gap <i>Rear wheel gap</i>		
	<input type="checkbox"/> 15 <input type="checkbox"/> 20 <input type="checkbox"/> 25 <i>Individual</i>	<input style="width: 100px; height: 20px;" type="text"/> mm	
Rear Wheel Options			
<input type="checkbox"/> XK010	Fusion 16 spoke <i>Fusion 16 spoke</i>	(Silver Hub, black spokes) <i>(Silver Hub, black spokes)</i>	<input type="checkbox"/> XK320
<input type="checkbox"/> XK050	Spineray LX 12 spoke <i>Spineray LX 12 spoke</i>		<input type="checkbox"/> XK060
<input type="checkbox"/> XK150	Spineray CLX 18 carbon blade spoke <i>Spineray CLX 18 carbon blade spoke</i>	<i>N/A IN SILVER HUB</i> <i>N/A IN SILVER HUB</i>	<input type="checkbox"/> XK070
Spineray Colour Options:			<input type="checkbox"/> XK180
<input type="checkbox"/> Black spokes <i>Black spokes</i>	<input type="checkbox"/> White spokes <i>White spokes</i>	<input type="checkbox"/> Yellow spokes <i>Yellow spokes</i>	Individual spoke design <i>Individual spoke design</i> Inside: _____ Outside: _____
<input type="checkbox"/> Red spokes <i>Red spokes</i>	<input type="checkbox"/> Blue spokes <i>Blue spokes</i>	<input type="checkbox"/> Pink spokes <i>Pink spokes</i>	
<input type="checkbox"/> Purple spokes <i>Purple spokes</i>	<input type="checkbox"/> Orange spokes <i>Orange spokes</i>	<input type="checkbox"/> Green spokes <i>Green spokes</i>	
Spineray Anodise Options			
<input type="checkbox"/> XK190	Black hub <i>Black hub</i>	<input type="checkbox"/> XK200	
<input type="checkbox"/> XK202	Purple hub/rims <i>Purple hub/rims</i>	<input type="checkbox"/> XK203	
<input type="checkbox"/> XK201	Red hub/rims <i>Red hub/rims</i>	<input type="checkbox"/> XK204	
<input type="checkbox"/> XK202	Purple hub/rims <i>Purple hub/rims</i>	<input type="checkbox"/> XK203	<input type="checkbox"/> XK204
Supply Without Wheels			
<input type="checkbox"/> XK040	Supply without Wheels and Axle Pins <i>Supply without Wheels and Axle Pins</i>		Wheel Type: <input style="width: 150px;" type="text"/> Tyre Type: <input style="width: 150px;" type="text"/>
Handrim Position / Options			
<input type="checkbox"/> XY480	Narrow set handrim <i>Narrow set handrim</i>	<input type="checkbox"/> XY485	Wide set handrim <i>Wide set handrim</i>
<input type="checkbox"/> XL090	Remove excess mounting tabs <i>Remove excess mounting tabs</i>	<i>(recommended for small wheel gaps)</i> <i>(recommended for small wheel gaps)</i>	
Handrim Styles			
<input type="checkbox"/> XL010	Aluminium hard anodised 6 tab <i>Aluminium hard anodised 6 tab</i>	<i>(Std if no option selected)</i> <i>(Std if no option selected)</i>	<input type="checkbox"/> XL040
<input type="checkbox"/> XL160	Elipse 6 tab <i>Elipse 6 tab</i>	<i>(replacement for Surge)</i> <i>(replacement for Surge)</i>	<input type="checkbox"/> XL035
<input type="checkbox"/> XL020	Tetra grip 6 tab <i>Tetra grip 6 tab</i>		<input type="checkbox"/> XL150
<input type="checkbox"/> XL100	Para grip 6 tab <i>Para grip 6 tab</i>		<input type="checkbox"/> XL170
Tyre Options			
<input type="checkbox"/> XM010	Kenda (Std) <input type="checkbox"/> Grey <input type="checkbox"/> Blue <input type="checkbox"/> Red <i>Kenda</i>	<input type="checkbox"/> XM060	Schwalbe One (24",25" only) <i>Schwalbe One (24",25" only)</i>
<input type="checkbox"/> XM130	Kenda black <i>Kenda black</i>	<input type="checkbox"/> XM050	Kenda K885 mountain bike tyre (24",25" only) <i>Kenda K885 mountain bike tyre (24",25" only)</i>
<input type="checkbox"/> XM020	Schwalbe Marathon Plus <i>Schwalbe Marathon Plus</i>		
<input type="checkbox"/> XM040	Shox solid airless (not with fusion wheels) <i>Shox solid airless (not with fusion wheels)</i>		
Inner Tube Valve Options			
<input type="checkbox"/> XY500	Schraeder inner tube valve <i>(Standard if no option selected)</i> <i>Schraeder inner tube valve</i>		<input type="checkbox"/> XY490
			Presta inner tube valve <i>Presta inner tube valve</i>
Wheel Accessories			
<input type="checkbox"/> XK310	Offroad wheel set 24" rim with handrim, MTB tyre and axle pins <i>(Replaces 26" wheel with XM010)</i>	<input type="checkbox"/> XK300	Offroad wheel set 22" rim with handrim, MTB tyre and axle pins <i>(Replaces 24" and 25" wheel with XM010)</i>
<input type="checkbox"/> XK130	Spokeguard with design (pair) <i>Spokeguard with design (pair)</i>	<input type="checkbox"/> fitted <input type="checkbox"/> not fitted <i>fitted not fitted</i>	<input type="checkbox"/> XK145
		<input type="checkbox"/> fitted <input type="checkbox"/> not fitted <i>fitted not fitted</i>	Black Gloss Spokeguards <i>Black Gloss Spokeguards</i>

FINISH OPTIONS					
Frame & Component Finish					
<input type="checkbox"/> XN010 Powder coated frame Powder coated frame		<input type="checkbox"/> XN150 Powder coated components <i>(Frame colour if not specified)</i> Powder coated components (Frame colour if not specified)			
<i>Frame Comp.</i>	Gloss	<i>Frame Comp.</i>	Matt	<i>Frame Comp.</i>	Special
<input type="checkbox"/>	<input type="checkbox"/> Black gloss 103	<input type="checkbox"/>	<input type="checkbox"/> Black matt 105	<input type="checkbox"/>	<input type="checkbox"/> Chrome Mirror 300
<input type="checkbox"/>	<input type="checkbox"/> White gloss 100	<input type="checkbox"/>	<input type="checkbox"/> White matt 101	<input type="checkbox"/>	<input type="checkbox"/> Sparkle silver 170
<input type="checkbox"/>	<input type="checkbox"/> Grey gloss 132	<input type="checkbox"/>	<input type="checkbox"/> Grey matt 131	<input type="checkbox"/>	<input type="checkbox"/> Metallic black matt 104
<input type="checkbox"/>	<input type="checkbox"/> Cream gloss 135	<input type="checkbox"/>	<input type="checkbox"/> Light grey matt 133	<input type="checkbox"/>	<input type="checkbox"/> Metallic grey matt 130
<input type="checkbox"/>	<input type="checkbox"/> Red gloss 108	<input type="checkbox"/>	<input type="checkbox"/> Navy blue matt 152	<input type="checkbox"/>	<input type="checkbox"/> Black sandpaper 201
<input type="checkbox"/>	<input type="checkbox"/> Yellow gloss 120			<input type="checkbox"/>	<input type="checkbox"/> Grey sandpaper 202
<input type="checkbox"/>	<input type="checkbox"/> Forest green gloss 143			<input type="checkbox"/>	<input type="checkbox"/> White sandpaper 200
<input type="checkbox"/>	<input type="checkbox"/> Green gloss 107				
<input type="checkbox"/>	<input type="checkbox"/> Dark blue gloss 151				
<input type="checkbox"/>	<input type="checkbox"/> Royal blue gloss 154				
<input type="checkbox"/>	<input type="checkbox"/> Blue gloss 174				
<input type="checkbox"/>	<input type="checkbox"/> Duckegg blue gloss 141				
<input type="checkbox"/>	<input type="checkbox"/> Pink gloss 188				
<input type="checkbox"/>	<input type="checkbox"/> Orange gloss 180				
<input type="checkbox"/>	<input type="checkbox"/> Purple gloss 157				
<input type="checkbox"/>	FXAXN030 Brushed frame <i>(All parts black unless XN160 chosen)</i> Brushed frame	<input type="checkbox"/>	XN160 Brushed components Brushed components		
<input type="checkbox"/>	FXAXN050 Polished frame <i>(All parts black unless XN170 chosen)</i> Polished frame	<input type="checkbox"/>	XN170 Polished components Polished components		
Accent Colour					
Note: Accent colour includes, forks & castor caps.					
<input type="checkbox"/>	Black accent	<input type="checkbox"/>	Silver accent		
<input type="checkbox"/>	Black accent	<input type="checkbox"/>	Silver accent		
<input type="checkbox"/>	Red accent	<input type="checkbox"/>	Blue accent		
<input type="checkbox"/>	Red accent	<input type="checkbox"/>	Blue accent		
<input type="checkbox"/>	Purple accent	<input type="checkbox"/>	Carbon accent <i>(Castor caps only, black for rest)</i>		
<input type="checkbox"/>	Purple accent	<input type="checkbox"/>	Carbon accent <i>(Castor caps only, black for rest)</i>		
UPHOLSTERY					
Seat Upholstery					
<input type="checkbox"/>	XP040 Seat sling adjustable tension with straps Seat sling adjustable tension with straps	<input type="checkbox"/>	XR050 Carbon fibre seat plate Carbon fibre seat plate	_____ mm <i>(STD XY020 - 20mm)</i>	
Backrest Upholstery					
<input type="checkbox"/>	XP050 Airtech backrest strap adjustable Airtech backrest strap adjustable	<input type="checkbox"/>	XP060 Backrest upgrade to full leather <i>(Black)</i> Backrest upgrade to full leather <i>(Black)</i>		
		<input type="checkbox"/>	XP070 Backrest upgrade to leather corners <i>(Black)</i> Backrest upgrade to leather corners <i>(Black)</i>		
Backrest Stitching Colour					
<input type="checkbox"/>	Silver	<input type="checkbox"/>	Black	<input type="checkbox"/>	Blue
<input type="checkbox"/>	Silver	<input type="checkbox"/>	Black	<input type="checkbox"/>	Blue
<input type="checkbox"/>	Red	<input type="checkbox"/>	Orange	<input type="checkbox"/>	Purple
<input type="checkbox"/>	Red	<input type="checkbox"/>	Orange	<input type="checkbox"/>	Purple
				<input type="checkbox"/>	Individual: _____
				<input type="checkbox"/>	Individual: _____
RGK Logo Colour					
<input type="checkbox"/>	White (Std)	<input type="checkbox"/>	Green	<input type="checkbox"/>	Blue
<input type="checkbox"/>	White (Std)	<input type="checkbox"/>	Green	<input type="checkbox"/>	Blue
<input type="checkbox"/>	Red	<input type="checkbox"/>	Orange	<input type="checkbox"/>	Purple
<input type="checkbox"/>	Red	<input type="checkbox"/>	Orange	<input type="checkbox"/>	Purple
				<input type="checkbox"/>	Individual: _____
				<input type="checkbox"/>	Individual: _____
Model Logo Colour					
<input type="checkbox"/>	White (Std)	<input type="checkbox"/>	Green	<input type="checkbox"/>	Blue
<input type="checkbox"/>	White (Std)	<input type="checkbox"/>	Green	<input type="checkbox"/>	Blue
<input type="checkbox"/>	Red	<input type="checkbox"/>	Orange	<input type="checkbox"/>	Purple
<input type="checkbox"/>	Red	<input type="checkbox"/>	Orange	<input type="checkbox"/>	Purple
				<input type="checkbox"/>	Individual: _____
				<input type="checkbox"/>	Individual: _____
Backrest Accessories					
<input type="checkbox"/>	XP110 Backrest with zip pocket Backrest with zip pocket	<input type="checkbox"/>	XP170 Individual backrest embroidery Individual backrest embroidery	PLEASE COMPLETE PAGE 11	

CUSHION				
Cushion foam options				
<input type="checkbox"/>	XP080	Cushion foam <i>(select density and size below)</i> Cushion foam <i>(select density and size below)</i>		
	<input type="checkbox"/>	Soft (CMS040) Soft (CMS040)	<input type="checkbox"/>	Medium (CMS050) Medium (CMS050)
	<input type="checkbox"/>	50mm 50mm	<input type="checkbox"/>	75mm 75mm
			<input type="checkbox"/>	100mm 100mm
Cushion cover Upgrades				
<input type="checkbox"/>	XP085	Nylon cushion cover <i>(Black)</i> Nylon cushion cover <i>(Black)</i>		
<input type="checkbox"/>	XP090	Air Lite cushion cover <i>(Black)</i> Air Lite cushion cover <i>(Black)</i>		
<input type="checkbox"/>	XP100	Leather cushion cover <i>(Black)</i> Leather cushion cover <i>(Black)</i>		
Jay Products - PLEASE PROVIDE JAY ORDER FORM				
<input type="checkbox"/>	JAY Cushion	<i>(Price dependant on size / option)</i> JAY Cushion <i>(Price dependant on size / option)</i>	<input type="checkbox"/>	Jay Order form attached Jay Order form attached
<input type="checkbox"/>	JAY Backrest	<i>(Price dependant on size / option)</i> JAY Backrest <i>(Price dependant on size / option)</i>	<input type="checkbox"/>	Jay Order form attached Jay Order form attached
<input type="checkbox"/>	JAY Whitmyer Headrest	<i>(Price dependant on size / option)</i> JAY Whitmyer Headrest <i>(Price dependant on size / option)</i>	<input type="checkbox"/>	Jay Order form attached Jay Order form attached
ACCESSORIES				
<input type="checkbox"/>	XR080	Frontwheel assembly <i>(Only with tubular and angle adjustable footrest)</i> Frontwheel assembly <i>(Only with tubular and angle adjustable footrest)</i>	<input type="checkbox"/>	<input type="checkbox"/>
			red	purple
			blue	silver
<input type="checkbox"/>	XP120	Frame protectors Neoprene zip fasten <i>(Black)</i> Frame protectors Neoprene zip fasten <i>(Black)</i>		
<input type="checkbox"/>	XP420	Frame protectors Nylon velcro fasten <i>(Black)</i> Frame protectors Nylon velcro fasten <i>(Black)</i>		
<input type="checkbox"/>	XR010	Seat pouch velcro attach <i>(Black)</i> Seat pouch velcro attach <i>(Black)</i>		
<input type="checkbox"/>	XR200	Rucksack with RGK logo <i>(Black)</i> Rucksack with RGK logo <i>(Black)</i>		
<input type="checkbox"/>	XR100	FX carry bag FX carry bag		
<input checked="" type="checkbox"/>	XR090	Tool kit Tool kit		
<input checked="" type="checkbox"/>	XS060	Calf strap Calf strap		

ADDITIONAL NOTES

INDIVIDUAL BACKREST EMBROIDERY

PLEASE PROVIDE JPEG IMAGE AT TIME OF ORDER AND NOTE POSITION BELOW



SPEC NOTES:

OFF SPEC REQUEST* *(please specify below the page number(s) and details to which the off spec request applies.*

OFF SPEC REQUEST APPROVED *(for internal RGK office only)*

X
RGK Internal Sign-off

Off spec requests require a feasibility study which may increase order price and lead time. Any dimension/ option/ frame request not listed on the order form will be treated as an off spec request.*