

SERIAL NO: _____

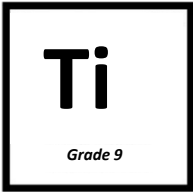

Customer Contact Details

Customer Name: _____

Advisor: _____

Address: _____

Phone: _____

Email: _____

Ship to Customer Address:

Shipping Name: _____

Shipping Address: _____

Phone: _____

Email: _____

Additional Information

Notes: _____

Current Wheelchair: _____

Customer Weight: _____

Customer Height: _____

Customer Disability: _____

Other

Guide:

Base product

Required option

Optional Extra



Critical Information



Information Needed



Non certified Sub4 weight option

PRODUCT STYLE

SBTXZ010 **OCTANE SUB4**
OCTANE SUB4

XA070 Open design
Open design

XA080 Closed design (Non Certified Sub4 option)
Closed design

Max User Weight 110kg (242lbs)

PLEASE NOTE: ALL RGK CHAIRS ARE HAND BUILT AND HAVE A MANUFACTURING MEASUREMENT TOLERANCE OF +/- 5MM

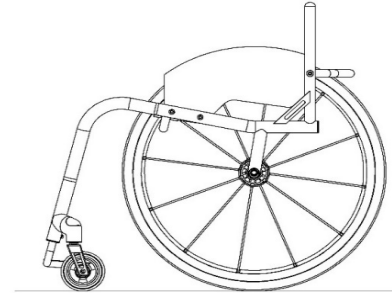

CAD APPROVAL

XW010 ORDER CAD drawing for approval (2 amendments ONLY)
ORDER CAD drawing for approval

XW009 QUOTE ONLY (NO CAD FOR APPROVAL)
QUOTE ONLY (NO CAD FOR APPROVAL)

XW012 QUOTE / CAD drawing for approval (2 amendments ONLY)
QUOTE / CAD drawing for approval

XW011 ORDER (NO CAD FOR APPROVAL)
ORDER (NO CAD FOR APPROVAL)

KEY MEASUREMENTS

XY010 Seat width (Inside of sideguards)
Seat width
 mm (Max - 440mm)
(Min - 250mm)

XY020 Seat length
Seat length
 mm (Max - 440mm)
(Min - 250mm)

XY030 Extra seat length (Provides additional leg support & hand grip)
Extra seat length
 mm (Max - 440mm total seat)

XY050 Front frame height
Front frame height
 mm (Max - 520mm)
(Min - 380mm)

XY060 Rear frame height
Rear frame height
 mm (Max - 500mm)
(Min - 360mm)

XY070 Frame length
Frame length
 mm (Max - 625mm)
(Min = XY020 + XY030 + 140mm)

XY072 Castor position
Castor position
 mm
 Optimise measurements
Optimise measurements

XA020 Ergonomic seat
Ergonomic seat
Specify length
 mm (Standard = 120mm)

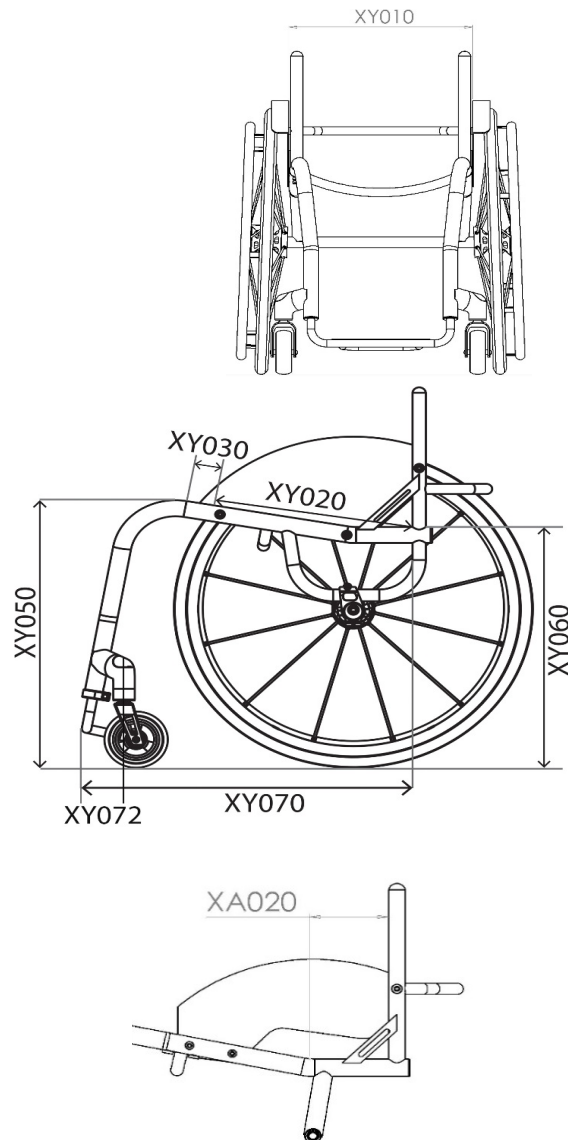

SERIAL NO: _____



FRONT FRAME AND FOOTREST

Front Frame Options

XY080 Seat taper design
Seat taper design

i Specify width mm

(When combined with XY091, dimension is inbetween the centre of the main bends)

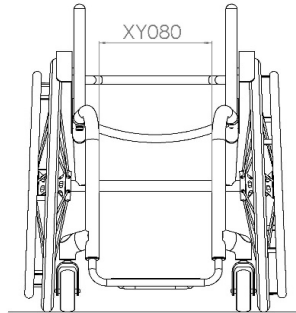

XY091 Parallel taper design
Parallel taper design

i Specify width mm

(When combined with XY080, dimensions must be smaller by 20mm)

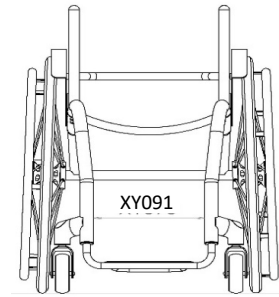

Footrest Design Choose One

XY100 Round design
Round design

Castor Wheel Size	Max Height Achievable
4"	110mm

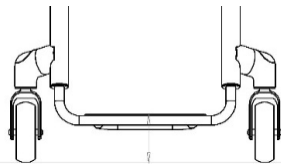

XY105 Square design
Square design

Castor Wheel Size	Max Height Achievable
4"	130mm

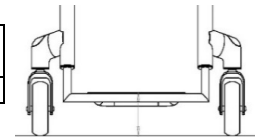

Footrest Measurements

XY115 Front footrest height
Front footrest height
! mm (Min - 40mm, 60mm for front wheel attachment)
(any footrest over 160mm move to highlevel footrest)

XY120 Rear footrest height
Rear footrest height
i mm Std = 20 lower than front height (Min - 40mm, 60mm for front wheel attachment)
(any footrest over 160mm move to highlevel footrest)

XY125 Footrest length
Footrest length
i mm Maximum length 140mm (Certified weight)
(160mm and over requires heavy duty upgrade XB150)
(160mm and over requires heavy duty upgrade XB150)

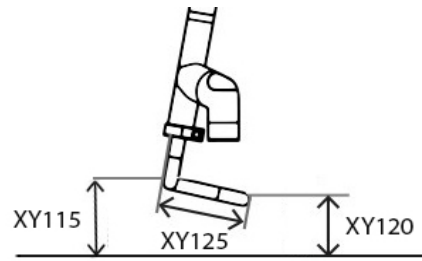

4 XB200 High level footrest (Non-certified Sub4 option)
High level footrest (Max - 100mm)
Indicate front footrest height:
 mm

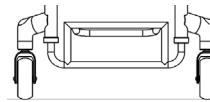

Footrest Style

XB025 Tubular Titanium footrest Sub4 (15.88mm x 1mm)
Tubular Titanium footrest Sub4 (Height adjustable)

4 XB020 Tubular titanium footrest (15.88mm x 1.2mm)
(Non Certified Sub4 option) (Height adjustable)
Tubular titanium footrest (Height adjustable)

Footrest Cover

XB045 Lightweight carbon fibre cover (With weight saving cut-out)
Lightweight carbon fibre cover (With weight saving cut-out)

Footplate width Sub4 certified (Std if no option selected)
Footplate width Sub4 certified (Std if no option selected)

4 No Cut-Out (Non Certified Sub4 option)
No Cut-Out

4 Footplate width Standard (optimised plate width)
(Non Certified Sub4 option)
Footplate width Standard (optimised plate width)

CASTOR WHEELS, FORKS & WHEEL LOCKS

Castor Wheels

- XC135 Aluminium centre 4"x1.25"
Aluminium centre 4"x1.25" *Choose colour below:*
Choose colour below:
- Silver hub & black tyre (Std)
Silver hub & black tyre (Std)
- Black hub & black tyre
Black hub & black tyre
- Purple hub & black tyre
Purple hub & black tyre
- Green hub & black tyre
Green hub & black tyre
- Red hub & black tyre
Red hub & black tyre
- Blue hub & black tyre
Blue hub & black tyre
- SBTXC155 Forged carbon centre 4"x1.4" (Non certified Sub4 option)
Forged carbon centre 4"x1.4"
- XC140 Aluminium centre 5"x1.4" (Non certified Sub4 option) *(Silver hub and black tyre only)*
Aluminium centre 5"x1.4" *(Silver hub and black tyre only)*
- XC145 Aluminium centre 6"x1.4" (Non certified Sub4 option) *(Silver hub and black tyre only)*
Aluminium centre 6"x1.4" *(Silver hub and black tyre only)*

Castor Forks

- XC190 Performance castor fork *(Std)*
Performance castor fork *(Std)* *Note: Colour follows accent*
- XC192 High trail castor fork
High trail castor fork *Note: Greater distance between contact patch and steering axis reduces flutter at higher speeds. Colour follows accent*

Castor Pin Width

- XY330 Castor pin width
Castor pin width
- Optimise measurements
(Minimum width for clear castor rotation and maximum wheelbase length)
- Optimise measurements
(Minimum width for clear castor rotation and maximum wheelbase length)

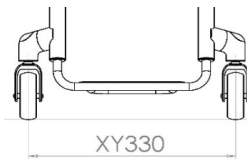

Wheel Lock Options

- SBTXD036 Compact scissor with lightweight fixing
Compact scissor with lightweight fixing
 - XD020 Underseat scissor (Non certified Sub4 option)
Underseat scissor
 - XD050 Push to lock (Non certified Sub4 option)
Push to lock
 - XD010 Omit wheel locks
Omit wheel locks
 - SBTXD085 Eagle wheel locks (Indicate colour) *(Non Certified Sub4 option)*
Eagle wheel locks (Indicate colour)
 - SBTXD086 Eagle WL with L/W fixing (Indicate colour) *(Only with fixed centre of gravity)* *(Non Certified Sub4 option)*
Eagle WL with L/W fixing (Indicate colour) *(Only with fixed centre of gravity)*
- BLACK PURPLE RED BLUE
 BLACK PURPLE RED BLUE
 Black Std if no option selected

SIDEGUARDS

Sideguard

- XE055 Screw on lightweight carbon fibre
Screw on lightweight carbon fibre

Sideguard Measurements

- Individual above tyre *(Follow tyre - max. 25mm)*
Individual above tyre *(Follow tyre - max. 25mm)*
 - Level with tyre *(Follow tyre)*
Level with tyre *(Follow tyre)*
-

Sideguard with Fender

- XE065 Screw on lightweight carbon fibre w/fender
Screw on lightweight carbon fibre w/fender

Sideguard Measurements

- 10mm above tyre *(Standard)*
10mm above tyre *(Standard)*
 - Individual above tyre *(Min = 10mm)*
Individual above tyre *(Min = 10mm)*
 - Centre of tyre
Centre of tyre
-

BACKREST

Backrest Measurements

XY230 Backrest height (Max - 400mm)
Backrest height (Max - 400mm)
Specify height

mm

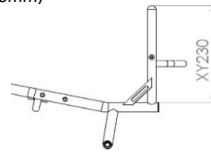

XG010 Fixed Backrest (non-folding)
Fixed Backrest (non-folding)

SBTXG020 Folding backrest with 2 position snap lock and angle adjust (Non certified Sub4 option)
Folding backrest with 2 position snap lock and angle adjust

Ergonomic Options

XY360 Backrest angle
Backrest angle

-5 -3 0 +3 +5

Individual Deg
(Max -10/+20 Deg)

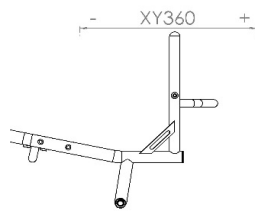

XG100 Ergonomic backrest
Ergonomic backrest

Vertical height mm

Rearward position mm

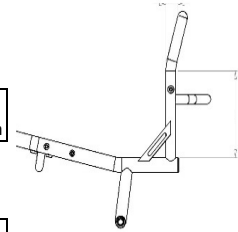

XG110 Inward taper (inside of backrest posts)
Inward taper (inside of backrest posts)

Specify width or per side mm

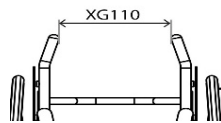

XG120 Outward flare (inside of backrest posts)
Outward flare (inside of backrest posts)

Specify width or per side mm

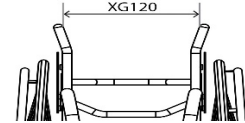

CAMBER BAR

Specify Camber Angle

XY390 Camber angle
Camber angle

! 1 2 3

Centre of Gravity

SBTXH100 Single post fixed centre of gravity
Single post fixed centre of gravity (25-125mm)

mm

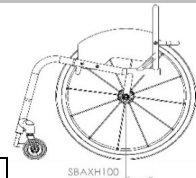

SBTXH130 Square back adjustable centre of gravity (25-125mm) (Non Certified Sub4 option)
Square back adjustable centre of gravity (25-125mm)

mm

SBTXH140 Round back adjustable centre of gravity (60-125mm) (Non Certified Sub4 option)
Round back adjustable centre of gravity (60-125mm)

mm

Camber Bar Options

XA226 Make Ready for Batec Bloc (Upgraded Camber Bar to suit)
Make Ready for Batec Bloc (Upgraded Camber Bar to suit)

XA227 Batec Bloc and Mount
Batec Bloc and Mount

XG070 Screw in push handles (Non Certified Sub4 option)
Screw in push handles

XG080 Flip down push handles (Non Certified Sub4 option)
Flip down push handles

XJ100 Single sport anti tip (Non Certified Sub4 option)
Single sport anti tip

FRAME FINISH OPTIONS

Frame and Footrest (Choose One)

- | | | | | |
|-----------------------------------|---|---|---|-----------------------------|
| <input type="checkbox"/> SBTXN030 | Bead Blast frame
Bead Blast frame | <input checked="" type="checkbox"/> XN010 | Powder coat frame
Powder coat frame | (Non certified Sub4 option) |
| <input type="checkbox"/> SBTXN050 | Polished frame
Polished frame | Paint code | <input type="text"/> | |
| | | Paint code | | |

Accent Colour (Choose One)

Note: Accent colour includes, forks & castor caps.

- | | |
|--|--|
| <input type="checkbox"/> Black accent
Black accent | <input type="checkbox"/> Silver accent
Silver accent |
| <input type="checkbox"/> Red accent
Red accent | <input type="checkbox"/> Blue accent
Blue accent |
| <input type="checkbox"/> Purple accent
Purple accent | |

UPHOLSTERY

Seat Upholstery

- | | | | | |
|--------------------------------|---|---|---|-----------------------------|
| <input type="checkbox"/> XP045 | Sub4 Seat sling strap adjustable
Sub4 Seat sling strap adjustable | <input checked="" type="checkbox"/> XR050 | Carbon fibre seat plate
Carbon fibre seat plate | (Non certified Sub4 option) |
| | | | <input type="text"/> | mm (STD XY020 - 20mm) |

Backrest Upholstery

- | | | | |
|--------------------------------|---|---|---|
| <input type="checkbox"/> XP035 | Airtech Sub4 backrest strap adjustable
Airtech Sub4 backrest strap adjustable | <input checked="" type="checkbox"/> XP050 | Airtech backrest strap adjustable
(Non certified Sub4 option)
Airtech backrest strap adjustable |
| | | <input checked="" type="checkbox"/> XP070 | Backrest upgrade to leather corners (Black)
(only with Airtech upholstery XP050)
(Non certified Sub4 option)
Backrest upgrade to leather corners (Black)
(only with Airtech upholstery XP050) |
| | | <input checked="" type="checkbox"/> XP110 | Backrest with zip pocket
(only with Airtech upholstery XP050)
(Non certified Sub4 option)
Backrest with zip pocket
(only with Airtech upholstery XP050) |
| | | <input checked="" type="checkbox"/> XP170 | Individual backrest embroidery
<i>Please complete page 9</i>
(only with Airtech upholstery XP050)
Individual backrest embroidery
(only with Airtech upholstery XP050) |

Backrest Upholstery Stitching Options

- | | | | |
|--|--|--|--|
| <input type="checkbox"/> Silver
Silver | <input type="checkbox"/> Black
Black | <input type="checkbox"/> Blue
Blue | <input type="checkbox"/> Individual:
Individual: |
| <input type="checkbox"/> Red
Red | <input type="checkbox"/> Orange
Orange | <input type="checkbox"/> Purple
Purple | _____ |

RGK Logo Colour

- | | | | |
|--|--|--|--|
| <input type="checkbox"/> White (Std)
White (Std) | <input type="checkbox"/> Black
Black | <input type="checkbox"/> Blue
Blue | <input type="checkbox"/> Individual:
Individual: |
| <input type="checkbox"/> Red
Red | <input type="checkbox"/> Orange
Orange | <input type="checkbox"/> Purple
Purple | _____ |

A REAR WHEELS (* non certified weight options)			
Rear Wheel Size			
<input type="checkbox"/> XY420	24" Wheels 24" Wheels	<input type="checkbox"/> XY430	25" Wheels 25" Wheels
Rear Wheel Gap			
<input checked="" type="checkbox"/> XY460	Rear wheel gap Rear wheel gap		
<input type="checkbox"/> 15	<input type="checkbox"/> 20	<input type="checkbox"/> 25	
Rear Wheel Options			
<input type="checkbox"/> XK075	Spinergy BLXL 18 blade spoke Spinergy BLXL 18 blade spoke	<i>N/A IN SILVER HUB</i> <i>N/A IN SILVER HUB</i>	<input type="checkbox"/> SBTXK150 Spinergy CLX 18 carbon blade spoke <i>N/A IN SILVER HUB</i> Spinergy CLX 18 carbon blade spoke <i>N/A IN SILVER HUB</i>
<input checked="" type="checkbox"/> XK226	Titanium 100mm quick release axle pins Titanium 100mm quick release axle pins		
Spinergy Colour Options: i			
<input type="checkbox"/> Black spokes	<input type="checkbox"/> White spokes	<input type="checkbox"/> Yellow spokes	<input type="checkbox"/> XK180 Individual spoke design (Specify colour) Individual spoke design (Specify colour) Inside: _____ Outside: _____
<input type="checkbox"/> Red spokes	<input type="checkbox"/> Blue spokes	<input type="checkbox"/> Pink spokes	
<input type="checkbox"/> Purple spokes	<input type="checkbox"/> Orange spokes	<input type="checkbox"/> Green spokes	
<input type="checkbox"/> Black spokes	<input type="checkbox"/> White spokes	<input type="checkbox"/> Yellow spokes	
<input type="checkbox"/> Red spokes	<input type="checkbox"/> Blue spokes	<input type="checkbox"/> Pink spokes	
<input type="checkbox"/> Purple spokes	<input type="checkbox"/> Orange spokes	<input type="checkbox"/> Green spokes	
Spinergy Anodise Options			
<input type="checkbox"/> XK190 Black hub (std option) Black hub (std option)	<input type="checkbox"/> XK200 Silver hub (n/a with BLXL/CLX) Silver hub (n/a with BLXL/CLX)	<input type="checkbox"/> XK201 Red hub/rims (LX, XLX & BLXL only) Red hub/rims (LX, XLX & BLXL only)	
<input type="checkbox"/> XK202 Purple hub/rims (LX, XLX & BLXL only) Purple hub/rims (LX, XLX & BLXL only)	<input type="checkbox"/> XK203 Blue hub/rims (LX, XLX & BLXL only) Blue hub/rims (LX, XLX & BLXL only)	<input type="checkbox"/> XK204 Gold hub/rims (LX, XLX & BLXL only) Gold hub/rims (LX, XLX & BLXL only)	
Supply Without Wheels			
<input type="checkbox"/> SBTXK040	Supply without Wheels and Axle Pins Supply without Wheels and Axle Pins	i Wheel Type: <input style="width: 150px;" type="text"/>	Tyre Type: <input style="width: 150px;" type="text"/>
Handrim Position / Options			
<input type="checkbox"/> XY480	Narrow set handrim Narrow set handrim	<input type="checkbox"/> XY485	Wide set handrim Wide set handrim
<input type="checkbox"/> XL090	Remove excess mounting tabs Remove excess mounting tabs	(recommended for small wheel gaps) (recommended for small wheel gaps)	
Handrim Styles			
<input type="checkbox"/> XL010	Aluminium hard anodised 6 tab Aluminium hard anodised 6 tab	(Std if no option selected) (Std if no option selected)	<input type="checkbox"/> XL040 Titanium 6 tab Titanium 6 tab
<input type="checkbox"/> XL160	Elipse 6 tab Elipse 6 tab	(replacement for Surge) (replacement for Surge)	<input type="checkbox"/> XL035 Natural Fit LT Natural Fit LT
<input type="checkbox"/> XL020	Tetra grip 6 tab Tetra grip 6 tab		<input type="checkbox"/> XL150 Carbolife Gekko Carbolife Gekko
<input type="checkbox"/> XL100	Para grip 6 tab Para grip 6 tab		<input type="checkbox"/> XL170 Carbolife Curve L (Black) Carbolife Curve L (Black)
			<input type="checkbox"/> Black Black <input type="checkbox"/> Silver Silver
Tyre Options			
<input type="checkbox"/> XM060	Schwalbe One (Lightest option) Schwalbe One (Lightest option)	<input type="checkbox"/> XM130	Kenda black Kenda black
<input type="checkbox"/> XM010	Kenda <input type="checkbox"/> Grey <input type="checkbox"/> Blue <input type="checkbox"/> Red Kenda Grey Blue Red	<input type="checkbox"/> XM050	Kenda K885 mountain bike tyre (24", 25" only) (24", 25" only)
<input type="checkbox"/> XM020	Schwalbe Marathon Plus Schwalbe Marathon Plus		Kenda K885 mountain bike tyre (24", 25" only) (24", 25" only)
<input type="checkbox"/> XM040	Shox solid airless (not with fusion wheels) Shox solid airless (not with fusion wheels)		
Inner Tube Valve Options			
<input type="checkbox"/> XY500	Schraeder inner tube valve (Standard if no option selected) Schraeder inner tube valve (Standard if no option selected)		<input type="checkbox"/> XY490 Presta inner tube valve Presta inner tube valve
Wheel Accessories			
<input type="checkbox"/> XK130	Spokeguard with design (pair) Spokeguard with design (pair)	<input type="checkbox"/> fitted <input type="checkbox"/> not fitted fitted not fitted	<input type="checkbox"/> XK145 Black Gloss Spokeguards Black Gloss Spokeguards
			<input type="checkbox"/> fitted <input type="checkbox"/> not fitted fitted not fitted

* Indicates options that are not part of the certified Sub4kg weight of the product

CUSHION (** non certified weight options)			
Cushion foam options			
<input type="checkbox"/>	XP080	Cushion foam Cushion foam	(select density and size below) (select density and size below)
<input type="checkbox"/>		Soft (CMS040) Soft (CMS040)	<input type="checkbox"/> Medium (CMS050) Medium (CMS050)
<input type="checkbox"/>		50mm 50mm	<input type="checkbox"/> 75mm 75mm <input type="checkbox"/> 100mm 100mm
Cushion cover upgrades			
<input type="checkbox"/>	XP085	Nylon cushion cover Nylon cushion cover	(Black) (Black)
<input type="checkbox"/>	XP090	Airlite cushion cover Airlite cushion cover	(Black) (Black)
<input type="checkbox"/>	XP100	Leather cushion cover Leather cushion cover	(Black) (Black)
Jay Products - PLEASE PROVIDE JAY ORDER FORM			
<input type="checkbox"/>	JAY Cushion (Price dependant on size / option) JAY Cushion	<input type="text" value="Refer to Jay Order Form"/>	
<input type="checkbox"/>	JAY Backrest (Price dependant on size / option) JAY Backrest	<input type="text" value="Refer to Jay Order Form"/>	
<input type="checkbox"/>	JAY Whitmyer Headrest (Price dependant on size / option) JAY Whitmyer Headrest	<input type="text" value="Refer to Jay Order Form"/>	
FRAME OPTIONS (** non certified weight options)			
<input type="checkbox"/>	XR060	Welded calf strap mounting loops Welded calf strap mounting loops	(To locate calf strap on front frame) (To locate calf strap on front frame)
		Specify height from floor <input type="text"/>	
<input type="checkbox"/>		Optimise measurements Optimise measurements	
ACCESSORIES (** non certified weight options)			
<input type="checkbox"/>	XR080	Frontwheel assembly Frontwheel assembly	(Only with tubular and angle adjustable footrest) (Only with tubular and angle adjustable footrest) <input type="checkbox"/> red <input type="checkbox"/> purple <input type="checkbox"/> blue <input type="checkbox"/> silver
<input type="checkbox"/>	XP120	Frame protectors Neoprene zip fasten Frame protectors Neoprene zip fasten	(Black) (Black)
<input type="checkbox"/>	XP420	Frame protectors Nylon velcro fasten Frame protectors Nylon velcro fasten	(Black) (Black)
<input type="checkbox"/>	XR010	Seat pouch velcro attach Seat pouch velcro attach	(Black) (Black)
<input type="checkbox"/>	XR200	Rucksack with RGK logo Rucksack with RGK logo	(Black) (Black)
<input checked="" type="checkbox"/>	XR090	Tool kit Tool kit	
<input checked="" type="checkbox"/>	XS065	Sub4 Calf Strap Sub4 Calf Strap	
** indicates options that, when chosen, will not enable RGK to guarantee a Sub4kg product weight			

ADDITIONAL NOTES

INDIVIDUAL BACKREST EMBROIDERY

PLEASE PROVIDE JPEG IMAGE AT TIME OF ORDER AND NOTE POSITION BELOW



BRACE BAR

SPEC NOTES:

OFF SPEC REQUEST*

(please specify below the page number(s) and details to which the off spec request applies.

**OFF SPEC REQUEST
APPROVED** *(for internal
RGK office only)*

X
RGK Internal Sign-off

Off spec requests require a feasibility study which may increase order price and lead time. Any dimension/ option/ frame request not listed on the order form will be treated as an off spec request.*