

**Ti**  
Grade 9



CE

**Customer Contact Details**

Customer Name: \_\_\_\_\_

Advisor: \_\_\_\_\_

Address: \_\_\_\_\_

\_\_\_\_\_

\_\_\_\_\_

\_\_\_\_\_

Phone: \_\_\_\_\_

Email: \_\_\_\_\_

Ship to Customer Address:

Shipping Name: \_\_\_\_\_

Shipping Address: \_\_\_\_\_

\_\_\_\_\_

\_\_\_\_\_

Phone: \_\_\_\_\_

Email: \_\_\_\_\_

**Additional Information**

Notes: \_\_\_\_\_

\_\_\_\_\_

\_\_\_\_\_

\_\_\_\_\_

Current Wheelchair: \_\_\_\_\_

Customer Weight: \_\_\_\_\_

Customer Height: \_\_\_\_\_

Customer Disability: \_\_\_\_\_

**Other**

Empty text box for additional notes.

Empty text box for additional notes.

Guide:

- Base product
- Required option
- Optional Extra
- Critical Information
- Information Needed

## PRODUCT STYLE

**FXTXZ010 OCTANE FX**  
**OCTANE FX**

**XA070** Open design  
Open design

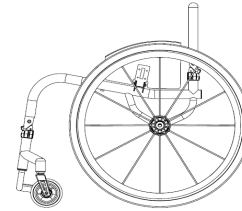

**Max User Weight 110kg (242lbs)**

**PLEASE NOTE: ALL RGK CHAIRS ARE HAND BUILT AND HAVE A MANUFACTURING MEASUREMENT TOLERANCE OF +/- 5MM**

## CAD APPROVAL

**XW009** QUOTE ONLY (NO CAD FOR APPROVAL)  
QUOTE ONLY (NO CAD FOR APPROVAL)

**XW011** ORDER (NO CAD FOR APPROVAL)  
ORDER (NO CAD FOR APPROVAL)

**XW012** QUOTE CAD drawing for approval  
(2 customer amendments ONLY)  
QUOTE CAD drawing for approval

**XW010** ORDER CAD drawing for approval  
(2 customer amendments ONLY)  
ORDER CAD drawing for approval

## KEY MEASUREMENTS

**XY010** Seat width (Inside of sideguards)  
Seat width  
  mm (Max - 460mm)  
(Min - 250mm)

**XY020** Seat length  
Seat length  
  mm (Max - 460mm)  
(Min - 250mm)

**XY030** Extra seat length (Provides additional leg support & hand grip)  
Extra seat length  
  mm

**XY050** Front frame height  
Front frame height  
  mm (Max - 550mm)  
(Min - 480mm)

**XY060** Rear frame height  
Rear frame height  
  mm (Max - 550mm)  
(Min - 360mm)

**XY070** Frame length  
Frame length  
  mm (Max 625mm)  
(Min XY020 + XY030 + 140mm)

**XY072** Castor position  
Castor position  
  mm  
 Optimise measurements  
Optimise measurements

**XA020** Ergonomic seat  
Ergonomic seat  
Specify length  
  mm (Standard = 120mm)

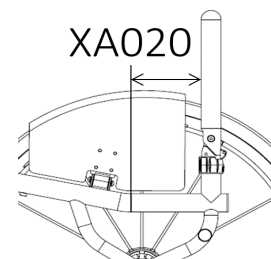
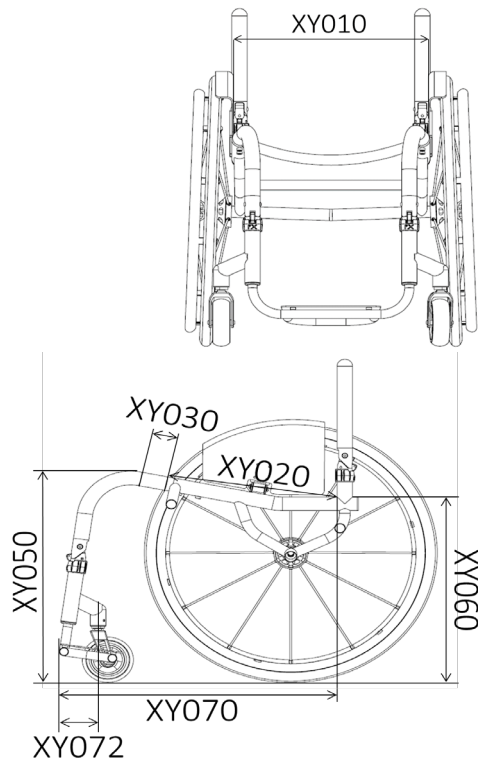

**FRONT FRAME AND FOOTREST**

Front Frame Options

XY080 Seat taper design  
Seat taper design

Specify width

mm

Optimise measurements (XY010 Seat Width -100mm)  
Optimise measurements (XY010 Seat Width -100mm)

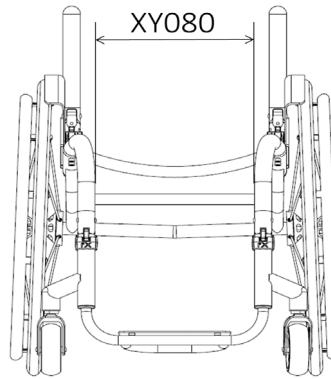

Footrest Design (Choose One)

XY100 Round design  
Round design

Castor Size	Max Height	With XB200
3"	115mm	165mm
4"	125mm	175mm
5"	135mm	185mm

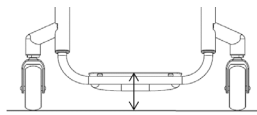

XY105 Square design  
Square design

Castor Size	Max Height	With XB200
3"	135mm	185mm
4"	145mm	195mm
5"	155mm	205mm

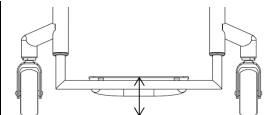

XB200 High level footrest (Only with XB010, XB080 & XB150)  
High level footrest (Only with XB010, XB080 & XB150)  
(Max - 100mm)

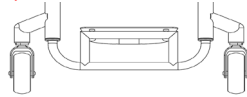

XB200 High level footrest (Only with XB010, XB080 & XB150)  
High level footrest (Only with XB010, XB080 & XB150)  
(Max - 100mm)

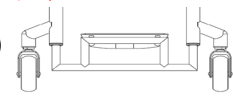

Footrest Individual Measurements

XY115 Front footrest height  
Front footrest height

mm

(Min - 50mm, 70mm for front wheel attachment)  
(any footrest over 160mm move to highlevel footrest)

XY120 Rear footrest height  
Rear footrest height

mm

(Std = 20 lower than front height)  
(Min - 50mm, 70mm for front wheel attachment)  
(any footrest over 160mm move to highlevel footrest)

XY125 Footrest length  
Footrest length

mm

(Std = 100mm)  
(160mm and over requires heavy duty upgrade XB150)  
(160mm and over requires heavy duty upgrade XB150)

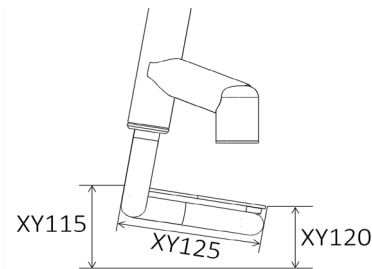

Footrest Style and Cover

FTXB080 Tubular footrest welded w/ Aluminium plate  
Tubular footrest welded w/ Aluminium plate (Supplied with spacer for +20mm adjustment)

FTXB110 Tubular footrest welded w/ Carbon Fibre plate  
Tubular footrest welded w/ Carbon Fibre plate (Supplied with spacer for +20mm adjustment)

FTXB120 Clamp-on aluminium plate footrest  
Clamp-on aluminium plate footrest (Angle/height adjustable)

Footrest Options

XB165 Rubber grip tape (3M safety walk)  
Rubber grip tape (3M safety walk)

## CASTOR WHEELS, FORKS & WHEEL LOCKS

### Castor Wheels 100mm (4")

- XC060 Soft roll 4"x1.3" **(Black only)**  
Soft roll 4"x1.3" **(Black only)**
- XC110 Aluminium centre 4"x1" **(Silver hub and black urethane tyre only)**  
Aluminium centre 4"x1" **(Silver hub and black urethane tyre only)**
- XC130 Aluminium centre 4"x1.4" **(Silver hub and black urethane tyre only)**  
Aluminium centre 4"x1.4" **(Silver hub and black urethane tyre only)**



- |   |   |   |
|---|---|---|
| <input type="checkbox"/> Silver hub & black tyre<br>Silver hub & black tyre | <input type="checkbox"/> Gold hub & black tyre<br>Gold hub & black tyre | <input type="checkbox"/> Purple hub & black tyre<br>Purple hub & black tyre |
| <input type="checkbox"/> Black hub & black tyre<br>Black hub & black tyre   | <input type="checkbox"/> Green hub & black tyre                         |   |
| <input type="checkbox"/> Red hub & black tyre<br>Red hub & black tyre       | <input type="checkbox"/> Blue hub & black tyre<br>Blue hub & black tyre |   |

### 125mm (5")

- |   |   |
|---|---|
| <input type="checkbox"/> XC070 Soft roll 5"x1.3" <b>(Black only)</b><br>Soft roll 5"x1.3" <b>(Black only)</b>                             | <input type="checkbox"/> XC120 Aluminium centre 5"x1" <b>(Silver hub and black urethane tyre only)</b><br>Aluminium centre 5"x1" <b>(Silver hub and black urethane tyre only)</b>     |
| <input type="checkbox"/> XC100 Pneumatic Aluminium centre 5"x1" <b>(Grey only)</b><br>Pneumatic Aluminium centre 5"x1" <b>(Grey only)</b> | <input type="checkbox"/> XC140 Aluminium centre 5"x1.4" <b>(Silver hub and black urethane tyre only)</b><br>Aluminium centre 5"x1.4" <b>(Silver hub and black urethane tyre only)</b> |

### 150mm (6")

- |   |   |
|---|---|
| <input type="checkbox"/> XC080 Soft roll 6"x1.3" <b>(Black hub / grey tyre only)</b><br>Soft roll 6"x1.3" <b>(Black hub / grey tyre only)</b> | <input type="checkbox"/> XC145 Aluminium centre 6"x1.4" <b>(Silver hub and black urethane tyre only)</b><br>Aluminium centre 6"x1.4" <b>(Silver hub and black urethane tyre only)</b> |
|---|---|

### Castor Forks

- |   |   |
|---|---|
| <input type="checkbox"/> XC190 Performance castor fork <b>(Std when no option selected)</b><br>Performance castor fork <b>(Std when no option selected)</b> | <input type="checkbox"/> XC210 Froglegs suspension castor fork<br>Froglegs suspension castor fork |
| <input type="checkbox"/> XC192 High trail castor fork<br>High trail castor fork   | <b>(i)</b> <input type="checkbox"/> Black<br>Black <input type="checkbox"/> Silver<br>Silver      |
- Note: Colour follows accent  
Note: Greater distance between contact patch and steering axis reduces flutter at higher speeds. Colour follows accent

### Castor Pin Width

- XY330 Castor pin width **(XY010 plus 70mm)**  
Castor pin width **(XY010 plus 70mm)**

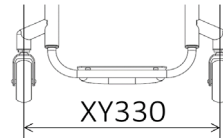



### Wheel Lock Options (Choose one)

- |   |   |
|---|---|
| <input type="checkbox"/> XD020 Underseat Scissor<br>Underseat Scissor   | <input type="checkbox"/> XD050 Push to lock<br>Push to lock   |
| <input type="checkbox"/> XD030 Compact scissor<br>Compact scissor   | <input type="checkbox"/> XD046 Out Front push to lock<br>Out Front push to lock   |
| <input type="checkbox"/> XD035 Compact scissor with lightweight fixing<br>(Only with fixed centre of gravity)<br>Compact scissor with lightweight fixing<br>(Only with fixed centre of gravity) | <input type="checkbox"/> XD085 Eagle wheel locks (Indicate colour)<br>Eagle wheel locks (Indicate colour)   |
| <input type="checkbox"/> XD010 Omit wheel locks<br>Omit wheel locks   | <input type="checkbox"/> XD086 Eagle WL with L/W fixing (Indicate colour)<br>(Only with fixed centre of gravity)<br>Eagle WL with L/W fixing (Indicate colour)<br>(Only with fixed centre of gravity) |
- BLACK     PURPLE     RED     BLUE  
 BLACK    PURPLE    RED    BLUE

Black Std if no option selected

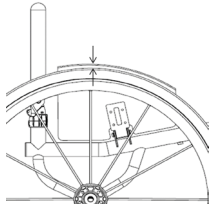
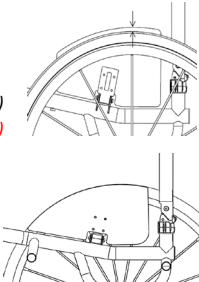
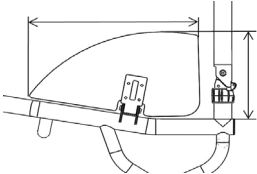
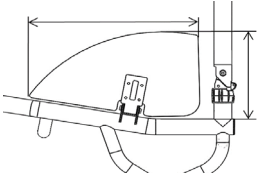
## SIDEGUARDS AND ARMRESTS

Sideguard	Sideguard with Fender
Aluminium Options	Aluminium Options
<input type="checkbox"/> XE080 Lift out aluminium <i>Lift out aluminium</i>	<input type="checkbox"/> XE090 Lift out aluminium with fender <i>Lift out aluminium with fender</i>
<input type="checkbox"/> FXTXE130 Fold flat aluminium <i>Fold flat aluminium</i>	<input type="checkbox"/> FXTXE140 Fold flat aluminium with fender <i>Fold flat aluminium with fender</i>
Carbon Fibre Options	Carbon Fibre Options
<input type="checkbox"/> XE100 Lift out carbon fibre <i>Lift out carbon fibre</i>	<input type="checkbox"/> XE110 Lift out carbon fibre with fender <i>Lift out carbon fibre with fender</i>
<input type="checkbox"/> FXTXE150 Fold flat carbon fibre <i>Fold flat carbon fibre</i>	<input type="checkbox"/> FXTXE160 Fold flat carbon fibre with fender <i>Fold flat carbon fibre with fender</i>
ABS Plastic Options	Sideguard Measurements
<input type="checkbox"/> XE120 Lift out ABS plastic <i>Lift out ABS plastic</i>	Fender height
<input type="checkbox"/> FXTXE170 Fold flat ABS plastic <i>Fold flat ABS plastic</i>	<input type="checkbox"/> 10mm above tyre <i>(Standard)</i> <i>10mm above tyre (Standard)</i>
	<input type="checkbox"/> Individual above tyre <i>Individual above tyre</i> <i>(Min = 10mm)</i>
	<input type="checkbox"/> <input style="width: 100px; height: 20px;" type="text"/> mm 
	Fender position
	<input type="checkbox"/> Centre of tyre <i>(Standard if no option selected)</i> <i>Centre of tyre</i> <i>(Standard if no option selected)</i>
	<input type="checkbox"/> Outside of tyre <i>Outside of tyre</i>
Sideguard Measurements	
Optimised measurements	
<input type="checkbox"/> 25mm above tyre <i>(Follow tyre)</i> <i>25mm above tyre (Follow tyre)</i>	
<input type="checkbox"/> Individual above tyre <i>(Follow tyre)</i> <i>Individual above tyre (Follow tyre)</i>	
<input type="checkbox"/> <input style="width: 100px; height: 20px;" type="text"/> mm 	
<input type="checkbox"/> Level with tyre <i>(Follow tyre)</i> <i>Level with tyre (Follow tyre)</i>	
Individual measurements	Armrest Options
<input type="checkbox"/> Sideguard length <i>Sideguard length</i>	<input type="checkbox"/> XF010 Lift out armrest with plastic sideguard <i>(Indicate fixed height)</i> <i>Lift out armrest with plastic sideguard</i> <i>(Indicate fixed height)</i>
<input type="checkbox"/> <input style="width: 100px; height: 20px;" type="text"/> mm 	<input type="checkbox"/> XF020 Lift out armrest with Aluminium sideguard <i>(Indicate fixed height)</i> <i>Lift out armrest with Aluminium sideguard</i> <i>(Indicate fixed height)</i>
<input type="checkbox"/> Sideguard height <i>Sideguard height</i>	<i>Height (Top of seatrail to top of armrest)</i> <i>Height (Top of seatrail to top of armrest)</i>
<input type="checkbox"/> <input style="width: 100px; height: 20px;" type="text"/> mm 	<input type="checkbox"/> <input style="width: 100px; height: 20px;" type="text"/> mm 

## BACKREST

### Backrest Height

XY230 Fixed height backrest (Max - 400mm)  
Fixed height backrest (Max - 400mm)

**i** Specify height  mm

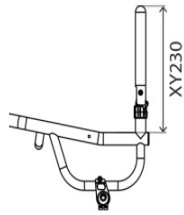

XY245 Adjustable height backrest (Max - 400mm) (+/-25mm)  
Adjustable height backrest (Max - 400mm) (+/-25mm)

**i** Specify height  mm

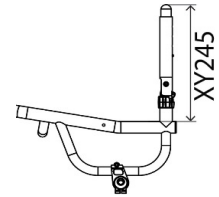

### Backrest Design

FXTXG060 Folding backrest with Q Lock (Black)  
Folding backrest with Q Lock (Black)

### Ergonomic Options

XY360 Backrest angle  
Backrest angle

**i**  -5  -3  0  +3  +5

Individual  Deg  
(Max -7/+7 Deg)

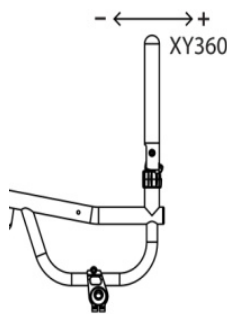

XG100 Ergonomic backrest  
Ergonomic backrest

**i** Vertical height  mm

**i** Rearward position  mm

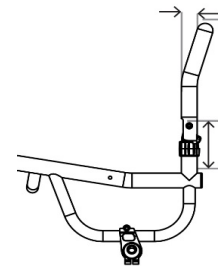

XG110 Inward taper (inside of backrest posts)  
Inward taper (inside of backrest posts)

**i** Specify width or per side  mm  
Specify width or per side

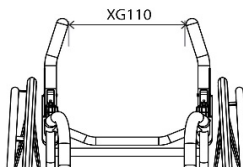

XG120 Outward flare (inside of backrest posts)  
Outward flare (inside of backrest posts)

**i** Specify width or per side  mm  
Specify width or per side

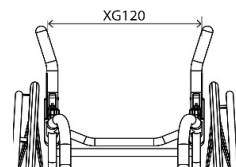

### Push handle Options

XG070 Screw in push handles  
Screw in push handles

XG080 Flip down push handles (N/A with XY245)  
Flip down push handles (N/A with XY245)

XG085 Flip down push handles height adjustable (N/A with XY245)  
Flip down push handles height adjustable (N/A with XY245)

XG097 Integrated push handle (quickie design) (N/A with XY245)  
Integrated push handle (quickie design) (N/A with XY245)

## CAMBER BAR

### Adjustable Centre of Gravity

- XH110 Square back adjustable centre of gravity (25-150mm)  
Square back adjustable centre of gravity (25-150mm)  
(Max seat width 500mm)  
(Max seat width 500mm)

Specify measurement

mm

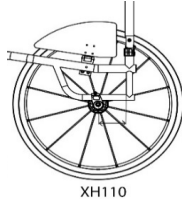

- XH120 Round back adjustable centre of gravity (60-150mm)  
Round back adjustable centre of gravity (60-150mm)

Specify measurement

mm

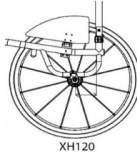

### Fixed Centre of Gravity

- FTXH090 V-style fixed centre of gravity (25-125mm)  
V-style fixed centre of gravity (25-125mm)

Specify measurement

mm

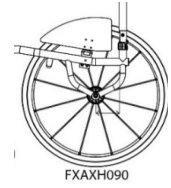

### Specify Camber Angle

- XY390 Camber angle  
Camber angle
- 0  1  2  3  5

### Specify Camber Angle

- XY390 Camber angle  
Camber angle
- 0  1  2  3  5

### Camber Bar Options

- FXTXK227 Standard Axle pin (120 or 130mm)  
Standard Axle pin (120 or 130mm)

- XK220 Titanium 130mm quick release axle pins (pair)  
(N/A with XK010, XK070 or FXTXK226)  
Titanium 130mm quick release axle pins (pair)  
(N/A with XK010, XK070 or FXTXK226)

- FXTXK226 100mm Titanium Axle pin (Fixed Axle only)  
100mm Titanium Axle pin (Fixed Axle only)

- XK240 Quad release axle nuts (pair)  
(N/A with FXTXK226)  
Quad release axle nuts (pair)  
(N/A with FXTXK226)

- XA226 Make Ready for Batec Bloc (Upgraded Camber Bar to suit)  
Make Ready for Batec Bloc (Upgraded Camber Bar to suit)

- XA227 Batec Bloc and Mount  
Batec Bloc and Mount

### Anti-Tip Options

- XJ010 Swingaway anti tip LEFT side  
(Only with square back frame. Not with XH040)  
Swingaway anti tip LEFT side  
(Only with square back frame. Not with XH040)

- XJ100 Single sport anti tip (centre mounted)  
Single sport anti tip (centre mounted)

- XJ020 Swingaway anti tip RIGHT side  
(Only with square back frame. Not with XH040)  
Swingaway anti tip RIGHT side  
(Only with square back frame. Not with XH040)

REAR WHEELS			
Rear Wheel Size			
<input type="checkbox"/> XY420	24" Wheels <i>24" Wheels</i>	<input type="checkbox"/> XY430	25" Wheels <i>25" Wheels</i>
Rear Wheel Gap			
<input checked="" type="checkbox"/> XY460	Rear wheel gap <i>Rear wheel gap</i>		
	<input type="checkbox"/> 15 <input type="checkbox"/> 20 <input type="checkbox"/> 25	Individual <input style="width: 100px;" type="text"/>	mm
Rear Wheel Options			
<input type="checkbox"/> XK010	Fusion 16 spoke <i>Fusion 16 spoke</i>	(Silver Hub, black spokes) <i>(Silver Hub, black spokes)</i>	<input type="checkbox"/> XK320
<input type="checkbox"/> XK050	Spinergy LX 12 spoke <i>Spinergy LX 12 spoke</i>		<input type="checkbox"/> XK060
<input type="checkbox"/> XK150	Spinergy CLX 18 carbon blade spoke <i>Spinergy CLX 18 carbon blade spoke</i>	<i>N/A IN SILVER HUB</i> <i>N/A IN SILVER HUB</i>	<input type="checkbox"/> XK070
<b>Spinergy Colour Options:</b>			
<input type="checkbox"/> Black spokes <i>Black spokes</i>	<input type="checkbox"/> White spokes <i>White spokes</i>	<input type="checkbox"/> Yellow spokes <i>Yellow spokes</i>	<input type="checkbox"/> XK180
<input type="checkbox"/> Red spokes <i>Red spokes</i>	<input type="checkbox"/> Blue spokes <i>Blue spokes</i>	<input type="checkbox"/> Pink spokes <i>Pink spokes</i>	Individual spoke design <i>(Specify colour)</i>
<input type="checkbox"/> Purple spokes <i>Purple spokes</i>	<input type="checkbox"/> Orange spokes <i>Orange spokes</i>	<input type="checkbox"/> Green spokes <i>Green spokes</i>	Individual spoke design <i>(Specify colour)</i>
<b>Spinergy Anodise Options</b>			
<input type="checkbox"/> XK190	Black hub <i>(std option)</i> <i>Black hub</i>	<input type="checkbox"/> XK200	Silver hub <i>(n/a with BLXL/CLX)</i> <i>Silver hub</i>
<input type="checkbox"/> XK202	Purple hub/rims <i>(LX, XLX &amp; BLXL only)</i> <i>Purple hub/rims</i>	<input type="checkbox"/> XK203	Blue hub/rims <i>(LX, XLX &amp; BLXL only)</i> <i>Blue hub/rims</i>
<input type="checkbox"/> XK201	Red hub/rims <i>(LX, XLX &amp; BLXL only)</i> <i>Red hub/rims</i>	<input type="checkbox"/> XK204	Gold hub/rims <i>(LX, XLX &amp; BLXL only)</i> <i>Gold hub/rims</i>
Supply Without Wheels			
<input type="checkbox"/> XK040	Supply without Wheels and Axle Pins <i>Supply without Wheels and Axle Pins</i>		Wheel Type: <input style="width: 150px;" type="text"/> Tyre Type: <input style="width: 150px;" type="text"/>
Handrim Position / Options			
<input type="checkbox"/> XY480	Narrow set handrim <i>Narrow set handrim</i>	<input type="checkbox"/> XY485	Wide set handrim <i>Wide set handrim</i>
<input type="checkbox"/> XL090	Remove excess mounting tabs <i>Remove excess mounting tabs</i>	<i>(recommended for small wheel gaps)</i>	
Handrim Styles			
<input type="checkbox"/> XL010	Aluminium hard anodised 6 tab <i>Aluminium hard anodised 6 tab</i>	<i>(Std if no option selected)</i> <i>(Std if no option selected)</i>	<input type="checkbox"/> XL040
<input type="checkbox"/> XL160	Elipse 6 tab <i>Elipse 6 tab</i>	<i>(replacement for Surge)</i> <i>(replacement for Surge)</i>	<input type="checkbox"/> XL035
<input type="checkbox"/> XL020	Tetra grip 6 tab <i>Tetra grip 6 tab</i>		<input type="checkbox"/> XL150
<input type="checkbox"/> XL100	Para grip 6 tab <i>Para grip 6 tab</i>		<input type="checkbox"/> XL170
Tyre Options			
<input type="checkbox"/> XM010	Kenda (Std) <i>Kenda</i>	<input type="checkbox"/> Grey <i>Grey</i>	<input type="checkbox"/> Blue <i>Blue</i>
<input type="checkbox"/> XM130	Kenda black <i>Kenda black</i>	<input type="checkbox"/> Red <i>Red</i>	<input type="checkbox"/> XM060
<input type="checkbox"/> XM020	Schwalbe Marathon Plus <i>Schwalbe Marathon Plus</i>		<input type="checkbox"/> XM050
<input type="checkbox"/> XM040	Shox solid airless, black (not with fusion wheels) <i>Shox solid airless, black (not with fusion wheels)</i>		<i>Kenda K885 mountain bike tyre (24", 25" only)</i> <i>Kenda K885 mountain bike tyre (24", 25" only)</i>
Inner Tube Valve Options			
<input type="checkbox"/> XY500	Schraeder inner tube valve <i>Schraeder inner tube valve</i>	<i>(Standard if no option selected)</i> <i>(Standard if no option selected)</i>	<input type="checkbox"/> XY490
Wheel Accessories			
<input type="checkbox"/> XK310	Offroad wheel set 24" rim with handrim, MTB tyre and axle pins (Replaces 26" wheel with XM010) <i>Offroad wheel set 24" rim with handrim, MTB tyre and axle pins (Replaces 26" wheel with XM010)</i>	<input type="checkbox"/> XK300	Offroad wheel set 22" rim with handrim, MTB tyre and axle pins (Replaces 24" and 25" wheel with XM010) <i>Offroad wheel set 22" rim with handrim, MTB tyre and axle pins (Replaces 24" and 25" wheel with XM010)</i>
<input type="checkbox"/> XK130	Spokeguard with design (pair) <i>Spokeguard with design (pair)</i>	<input type="checkbox"/> fitted <i>fitted</i>	<input type="checkbox"/> not fitted <i>not fitted</i>
<input type="checkbox"/> XK145	Black Gloss Spokeguards <i>Black Gloss Spokeguards</i>	<input type="checkbox"/> fitted <i>fitted</i>	<input type="checkbox"/> not fitted <i>not fitted</i>

## FINISH OPTIONS

### Frame & Component Finish

- |   |   |
|---|---|
| <input type="checkbox"/> XN010 Powder coated frame<br>Powder coated frame | <input type="checkbox"/> XN150 Powder coated components (Frame colour if not specified)<br>Powder coated components (Frame colour if not specified) |
| <b>Frame Comp.</b>  | <b>Frame Comp.</b>  |
| <b>Gloss</b>  | <b>Matt</b>   |
| <b>Special</b>  |   |
- |  |   |   |
|--|---|---|
| <input type="checkbox"/> <input type="checkbox"/> Black gloss 103        | <input type="checkbox"/> <input type="checkbox"/> Black matt 105      | <input type="checkbox"/> <input type="checkbox"/> Chrome Mirror 300       |
| <input type="checkbox"/> <input type="checkbox"/> White gloss 100        | <input type="checkbox"/> <input type="checkbox"/> White matt 101      | <input type="checkbox"/> <input type="checkbox"/> Sparkle silver 170      |
| <input type="checkbox"/> <input type="checkbox"/> Grey gloss 132         | <input type="checkbox"/> <input type="checkbox"/> Grey matt 131       | <input type="checkbox"/> <input type="checkbox"/> Metallic black matt 104 |
| <input type="checkbox"/> <input type="checkbox"/> Cream gloss 135        | <input type="checkbox"/> <input type="checkbox"/> Light grey matt 133 | <input type="checkbox"/> <input type="checkbox"/> Metallic grey matt 130  |
| <input type="checkbox"/> <input type="checkbox"/> Red gloss 108          | <input type="checkbox"/> <input type="checkbox"/> Navy blue matt 152  | <input type="checkbox"/> <input type="checkbox"/> Black sandpaper 201     |
| <input type="checkbox"/> <input type="checkbox"/> Yellow gloss 120       |   | <input type="checkbox"/> <input type="checkbox"/> Grey sandpaper 202      |
| <input type="checkbox"/> <input type="checkbox"/> Forest green gloss 143 |   | <input type="checkbox"/> <input type="checkbox"/> White sandpaper 200     |
| <input type="checkbox"/> <input type="checkbox"/> Green gloss 107        |   |   |
| <input type="checkbox"/> <input type="checkbox"/> Dark blue gloss 151    |   |   |
| <input type="checkbox"/> <input type="checkbox"/> Royal blue gloss 154   |   |   |
| <input type="checkbox"/> <input type="checkbox"/> Blue gloss 174         |   |   |
| <input type="checkbox"/> <input type="checkbox"/> Duckegg blue gloss 141 |   |   |
| <input type="checkbox"/> <input type="checkbox"/> Pink gloss 188         |   |   |
| <input type="checkbox"/> <input type="checkbox"/> Orange gloss 180       |   |   |
| <input type="checkbox"/> <input type="checkbox"/> Purple gloss 157       |   |   |
- |  |   |
|--|---|
| <input type="checkbox"/> FXTXN030 Beadblast frame (All parts black unless XN160 chosen)<br>Beadblast frame | <input type="checkbox"/> XN165 Beadblast components<br>Beadblast components |
| <input type="checkbox"/> FXTXN050 Polished frame (All parts black unless XN170 chosen)<br>Polished frame   | <input type="checkbox"/> XN170 Polished components<br>Polished components   |

### Accent Colour (Choose One)

**Note:** Accent colour includes forks only

- |   |   |
|---|---|
| <input type="checkbox"/> Black accent<br>Black accent   | <input type="checkbox"/> Silver accent<br>Silver accent |
| <input type="checkbox"/> Red accent<br>Red accent       | <input type="checkbox"/> Blue accent<br>Blue accent     |
| <input type="checkbox"/> Purple accent<br>Purple accent |   |

## UPHOLSTERY

### Seat Upholstery

- |   |   |
|---|---|
| <input type="checkbox"/> XP040 Seat sling strap adjustable<br>Seat sling strap adjustable | <input type="checkbox"/> XR050 Carbon fibre seat plate<br>Carbon fibre seat plate |
|   | <input type="text" value=""/> mm (STD XY020 - 20mm)                               |

### Backrest Upholstery

- |   |   |
|---|---|
| <input type="checkbox"/> XP050 Airtech backrest strap adjustable<br>Airtech backrest strap adjustable | <input type="checkbox"/> XP060 Backrest upgrade to full leather (Black)<br>Backrest upgrade to full leather (Black)       |
|   | <input type="checkbox"/> XP070 Backrest upgrade to leather corners (Black)<br>Backrest upgrade to leather corners (Black) |

### RGK Logo Colour

- |   |   |   |   |
|---|---|---|---|
| <input type="checkbox"/> White (Std)<br>White (Std) | <input type="checkbox"/> Green<br>Green   | <input type="checkbox"/> Blue<br>Blue     | <input type="checkbox"/> Individual:<br>Individual: |
| <input type="checkbox"/> Red<br>Red                 | <input type="checkbox"/> Orange<br>Orange | <input type="checkbox"/> Purple<br>Purple | _____   |

### Model Logo Colour

- |   |   |   |   |
|---|---|---|---|
| <input type="checkbox"/> White (Std)<br>White (Std) | <input type="checkbox"/> Green<br>Green   | <input type="checkbox"/> Blue<br>Blue     | <input type="checkbox"/> Individual:<br>Individual: |
| <input type="checkbox"/> Red<br>Red                 | <input type="checkbox"/> Orange<br>Orange | <input type="checkbox"/> Purple<br>Purple | _____   |

### Backrest Accessories

- |   |  |   |
|---|--|---|
| <input type="checkbox"/> XP110 Backrest with zip pocket<br>Backrest with zip pocket | (N/A with Sub4 backrest)<br>(N/A with Sub4 backrest) | <input type="checkbox"/> XP170 Individual backrest embroidery<br>Individual backrest embroidery |
|---|--|---|
- PLEASE COMPLETE PAGE 11

CUSHION			
Cushion foam options			
<input type="checkbox"/>	XP080	Cushion foam <i>Cushion foam</i>	<i>(select density and size below)</i> <i>(select density and size below)</i>
<input type="checkbox"/>		Soft (CMS040) <i>Soft (CMS040)</i>	<input type="checkbox"/>
<input type="checkbox"/>		Medium (CMS050) <i>Medium (CMS050)</i>	<input type="checkbox"/>
<input type="checkbox"/>		50mm <i>50mm</i>	<input type="checkbox"/>
<input type="checkbox"/>		75mm <i>75mm</i>	<input type="checkbox"/>
<input type="checkbox"/>		100mm <i>100mm</i>	
Cushion cover upgrades			
<input type="checkbox"/>	XP085	Nylon cushion cover <i>Nylon cushion cover</i>	<i>(Black)</i> <i>(Black)</i>
<input type="checkbox"/>	XP090	Air Lite cushion cover <i>Air Lite cushion cover</i>	<i>(Black)</i> <i>(Black)</i>
<input type="checkbox"/>	XP100	Leather cushion cover <i>Leather cushion cover</i>	<i>(Black)</i> <i>(Black)</i>
Jay Products - PLEASE PROVIDE JAY ORDER FORM			
<input type="checkbox"/>	JAY Cushion <i>JAY Cushion</i>	<i>(Price dependant on size / option)</i> <i>(Price dependant on size / option)</i>	<input type="checkbox"/>
<input type="checkbox"/>			<i>Jay Order form attached</i> <i>Jay Order form attached</i>
<input type="checkbox"/>	JAY Whitmyer Headrest <i>JAY Whitmyer Headrest</i>	<i>(Price dependant on size / option)</i> <i>(Price dependant on size / option)</i>	<input type="checkbox"/>
<input type="checkbox"/>			<i>Jay Order form attached</i> <i>Jay Order form attached</i>
ACCESSORIES			
<input type="checkbox"/>	XR080	Frontwheel assembly <i>Frontwheel assembly</i>	<i>(Only with tubular and angle adjustable footrest)</i> <i>(Only with tubular and angle adjustable footrest)</i>
<input type="checkbox"/>			<input type="checkbox"/> <i>red</i>
<input type="checkbox"/>			<input type="checkbox"/> <i>purple</i>
<input type="checkbox"/>			<input type="checkbox"/> <i>blue</i>
<input type="checkbox"/>			<input type="checkbox"/> <i>silver</i>
<input type="checkbox"/>	XP120	Frame protectors Neoprene zip fasten <i>Frame protectors Neoprene zip fasten</i>	<i>(Black)</i> <i>(Black)</i>
<input type="checkbox"/>	XP420	Frame protectors Nylon velcro fasten <i>Frame protectors Nylon velcro fasten</i>	<i>(Black)</i> <i>(Black)</i>
<input type="checkbox"/>	XR010	Seat pouch velcro attach <i>Seat pouch velcro attach</i>	<i>(Black)</i> <i>(Black)</i>
<input type="checkbox"/>	XR200	Rucksack with RGK logo <i>Rucksack with RGK logo</i>	<i>(Black)</i> <i>(Black)</i>
<input type="checkbox"/>	XR100	FX carry bag <i>FX carry bag</i>	
<input checked="" type="checkbox"/>	XR090	Tool kit <i>Tool kit</i>	<b>NEW!</b>
<input checked="" type="checkbox"/>	XS060	Calf strap <i>Calf strap</i>	

ADDITIONAL NOTES

INDIVIDUAL BACKREST EMBROIDERY

PLEASE PROVIDE JPEG IMAGE AT TIME OF ORDER AND NOTE POSITION BELOW



SPEC NOTES:

OFF SPEC REQUEST\*

*(please specify below the page number(s) and details to which the off spec request applies.*

**OFF SPEC REQUEST  
APPROVED** *(for internal  
RGK office only)*

X

*RGK Internal Sign-off*

Off spec requests require a feasibility study which may increase order price and lead time. Any dimension/ option/ frame request not listed on the order form will be treated as an off spec request.\*