



# Triton

INSTRUCTION MANUAL



# CONTENTS

Introduction .....	3
Where to find the Serial No & Size Labels .....	3
Measurements & Useful Info.....	4
Seating System Components .....	5
Important Safety Advice .....	6
Important Safety Advice -(Accessories).....	7
Operating Brakes (Indoor Base Frames) .....	7
Important - Chest Harness Adjustment .....	8
Important - Lap Strap Safety .....	9
Useful Info - Adjustment Points & Lever Use .....	10
Lever Use - Using Index Plungers.....	11
Adjusting Shoulder Protraction Pads .....	11
Mounting of Seating Unit.....	12
Removal of Seating Unit.....	13
Manual Seat Height Adjustment-(Multi Height & Tilt Base) .....	13
Powered Base Height Adjustment (upgrade option) .....	13
Tilt In Space - (Multi Height & Tilt Base).....	14
Folding Push Handle - (Multi Height & Tilt Base) .....	14
5 Star Base Adjustments - (Raise, Lower, Tilt in Space) .....	15
Back Angle Adjustment .....	16
Back Height Adjustment - Dynamic .....	16
Adjusting Seat Depth .....	17
Split Seat Adjustment (Leg Length Discrepancy) .....	17
Fitting a Tray .....	18
Sacral Pad Adjustment .....	18
Hip Pad Adjustment .....	19
Thigh Pad Adjustment.....	19
Headrest Adjustment .....	20
Long Sitting Pad Adjustment .....	20
Lateral Support Adjustment .....	21
Pommel Adjustment .....	21
Leg Rest Angle Adjustment .....	22
Arm Rest Positioning.....	22
Footrest, Footplate & Sandal Adjustment.....	23
Setting Up the Dynamic Back Mechanism .....	24-25
Cleaning & Care.....	26
General Maintenance.....	26
Servicing via Approved Repairer.....	27
Service Record Log.....	28
Warranty .....	29
Inspecting & Reissuing of Equipment.....	30-31

# Introduction

The Triton is designed to provide comfort and postural support. The system is available in seven sizes across three models to accommodate children from as young as 6 months through to adult.

This instruction manual contains very important information about the Triton seating system, how to use it safely and obtain the best results from it. Please read all the information contained in this manual before using the chair and retain for future reference. Ensure everyone using the equipment is aware of the contents of this manual and understands how to use the equipment safely.

These instructions provide guidance on the adjustments for professionals, but they also give information on how the equipment should be safely used, maintained, checked, and correctly assembled by anyone who uses the seating system.

In every case the equipment should be supplied via qualified professionals who will have adjusted the equipment, checked its compliance and tested it appropriately.

The seating system should only ever be adjusted by qualified professionals and persons that are suitably trained. For further information please do not hesitate to contact us - all contact details are on the back cover of the manual.

*Thank you for purchasing our product, we hope you enjoy your new seating system.*

## Where to find the Serial No & Size Labels

### Serial Number

Located at the lower back of the seat on the inside of the back angle adjustment section.



### Handle Size

Located on the right hand side of the handle where the handle feeds beneath the seating unit.



### Seating Unit Size

Located on the right hand side underneath the seating unit, just above where the leg rest joins.



The model name can be found either side of the seat here.

# Measurements & Useful Info

MEASUREMENTS (mm)	Triton 0		Triton 1		Triton 1 Long		Triton 2		Triton 2 Long		Triton 3		Triton 3 Long		Triton 4	
	MIN	MAX	MIN	MAX	MIN	MAX	MIN	MAX	MIN	MAX	MIN	MAX	MIN	MAX	MIN	MAX
<b>A</b> Seat Depth	150	300	225	325	300	400	300	400	375	475	375	475	450	550	450	550
<b>B</b> Seat to Top of * Back	250	350	350	475	400	525	400	525	475	625	475	625	525	675	525	675
<b>C</b> Chest Breadth	125	225	150	270	150	270	150	270	150	270	250	370	250	370	250	370
<b>D</b> Seat to Footplate	130	210	215	295	295	375	295	375	360	440	360	440	430	510	430	510
<b>E</b> Seat Width (Between Hip Pads)	150	275	170	325	170	325	220	375	220	375	270	425	270	425	320	475
<b>F</b> Floor to Seat	100mm Castors: Min 355 Max 815 / 75mm Castors: Min 325 Max 785															
<b>G</b> Tilt in Space / Prone	Prone 17° Tilt 25°															
<b>H</b> Back Angle	25° Recline 5° Forward															
<b>I</b> Base Footprint	740 x 570															
<b>J</b> User Weight	Maximum 100 kgs															

\* Primo back will go approximately 30mm lower.

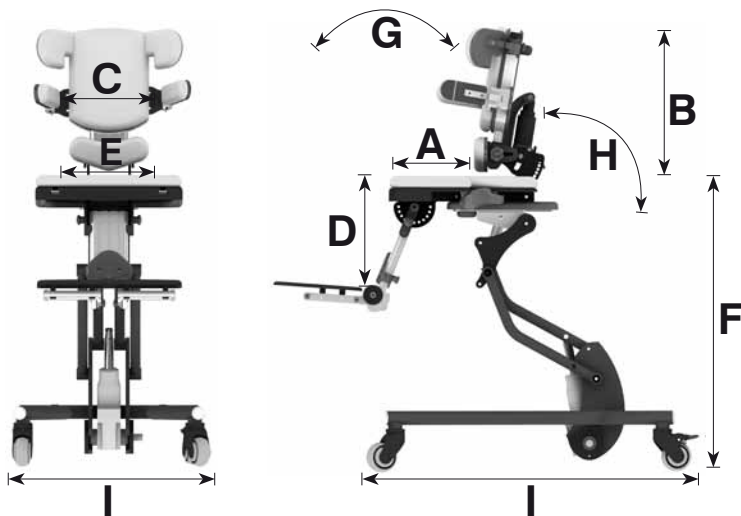

Chair Size	Triton 0	Triton 1	Triton 1 Long	Triton 2	Triton 2 Long	Triton 3	Triton 3 Long	Triton 4
Chair Weight	4 kgs	7.4 kgs	8.1 kgs	9 kgs	10.2 kgs	12.4 kgs	12.6 kgs	13.8 kgs
Dynamix Chair Weight	N/A	8.1 kgs	8.8 kgs	9.7 kgs	10.9 kgs	13.1 kgs	13.3 kgs	14.5 kgs

# Seating System Components

- A Push Handle
- B Headrest
- C Shoulder Protraction Pads
- D Lateral Supports
- E Hip Pads
- F Adjustable Thigh Pads
- G Footplate
- H Castors
- I Multi Height & Tilt Base
- J Tray Fixing Holes
- K Armrest
- L Legrest

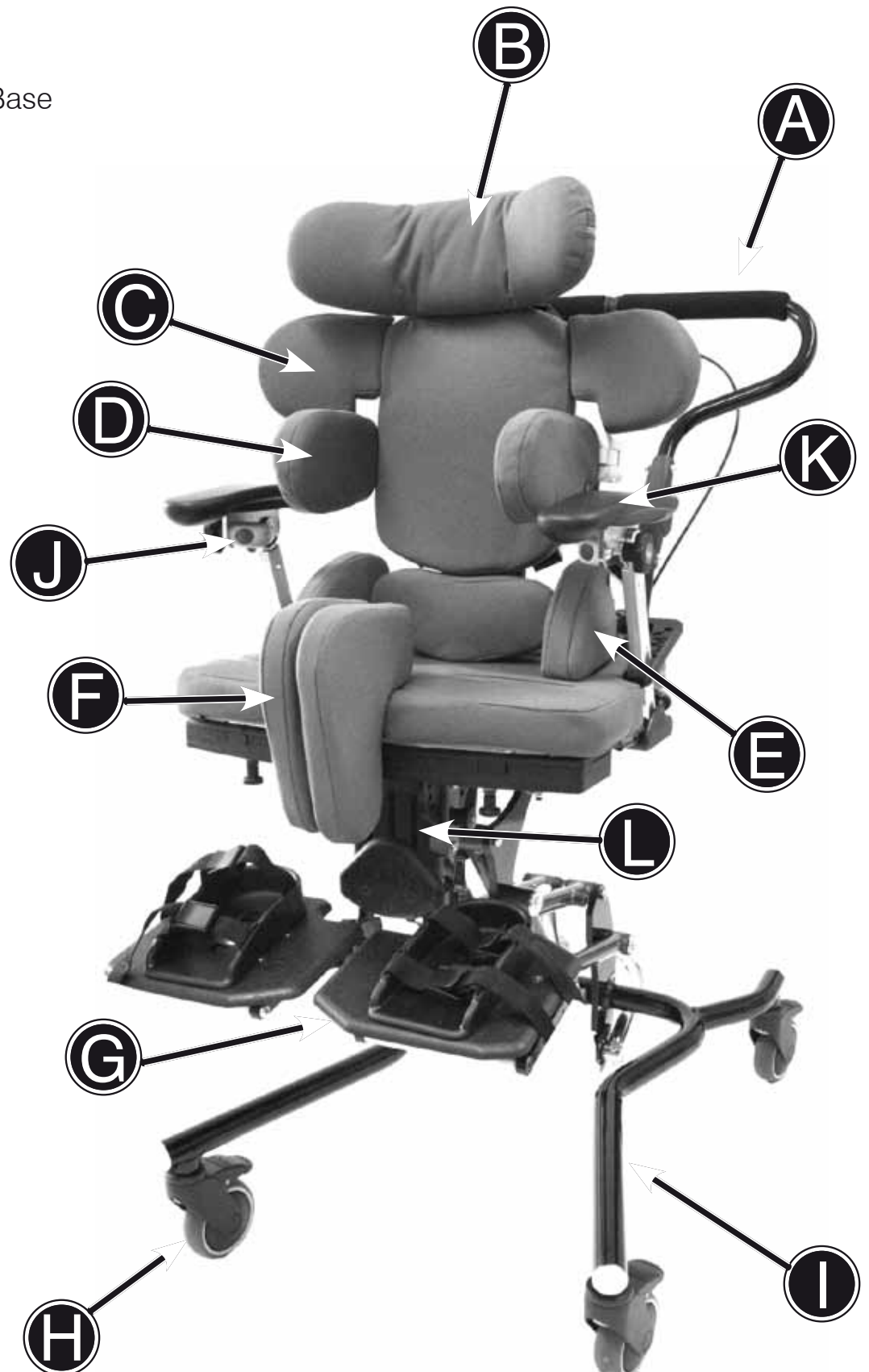

# Important Safety Advice



We at JCM are committed to producing products of the highest standard. All of our products fulfil the essential safety and environmental requirements as defined in the European Directives. However, improper use of the products will potentially put the users at risk and therefore JCM strongly suggest that the following information is strictly adhered to at all times.

Throughout the manual there are important points to note identified by the symbol:



- Ensure all adjustment mechanisms are secure and in place before operation. If it is likely that the hand-wheels will be repeatedly loosened, JCM can supply allen key bolts as an alternative. We strongly recommend this if there is a danger from those in the vicinity of the user.
- After completing any alterations ENSURE all nuts, bolts, knobs, hand wheels and other fixings are securely tightened and in position, and that they are regularly checked as part of the maintenance of the chair. Never over adjust or over tighten moving parts.
- All postural support straps and harnesses should be in place and properly adjusted to the user, prior to usage of any kind (see pages 8 & 9).
- When fitted to an indoor base frame the Triton should always be positioned on a level, flat floor. The Triton chair can be moved between one working area and another. For safety ALWAYS return the product to a neutral position and lower before moving (lower in height, level the seat, ensure the back is upright etc). After the chair has been moved and during use the chair should be placed in a static position with the brakes applied. Indoor base frames such as the multi height and tilt base are designed to be used inside, however it is acceptable to take these bases externally for a brief period if transferring the chair from one indoor area to another.
- Heavy items on the tray will affect stability. The fitting of anything other than the standard JCM tray may substantially affect the stability of the seating system and should therefore be checked before issue.
- If at any time it is noted that areas of the users skin remain reddened after being out of the seating system for around 10 minutes, urgently contact the qualified professional who performed the hand over of the equipment. This may be a sign of excessive pressure being exerted by the seating. This might occur in the initial use of a new seat where further adjustment may be required, where the user has been badly placed, grown or where an underlying medical problem exists. Review may be necessary in such cases
- Keep all products away from excessive sources of heat, cigarettes and naked flames.
- If you suspect that the system may be faulty, cease use of the equipment straight away and immediately contact the organization who supplied the system. (JCMs contact information can be found on the back cover).
- The equipment will be labelled with important information. NEVER REMOVE these information labels or allow them to be defaced, overlaid or altered.
- All modifications, adjustments, reconditioning, repairs, disposal, and servicing of the seating unit must ONLY be carried out by the agencies who supplied the equipment (see pages 26-27).

# Important Safety Advice -(Accessories)

## Multi Adjustable Head support

Wings on the head support are ideally set at 45 degrees. Do NOT bring the wings in tight to the head. Ensure that the head support is set in such a way that the child cannot loop their head around the wings and get stuck.

## Flexi-Supports and Lateral Supports

Ensure the straps do not infringe on any feeding tubes the child may have.

## Pommel

The pommel is designed to abduct the users knees to help keep the hips in a good position. Do NOT use the pommel as a way of holding the user in the seat. Remove the pommel when transferring the user in and out of the seat (not required for Star X Series.)

## Foot Sandals and Straps

Should only be fixed when the user is wearing shoes or boots.

## Tray

Do NOT use the tray as a way of securing children in a chair always ensure that the lap strap and any other straps supplied are used. Ensure that the tray clips are secure on both sides of the tray. If the tray is damaged, ensure that this will not be a hazard to the user. Never leave hot items on the tray while children are unattended.

# Operating Brakes (Indoor Base Frames)

## Applying Brakes

Depress lever (B) with your foot. To secure the chair in place you should suppress all the brakes fitted to the wheels on the base.

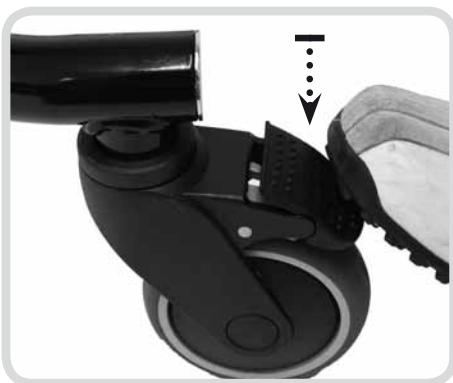

## Releasing Brakes

To release the brakes you should flick the levers up using the top of your foot. When all brakes are released the chair will be free to travel in any direction.

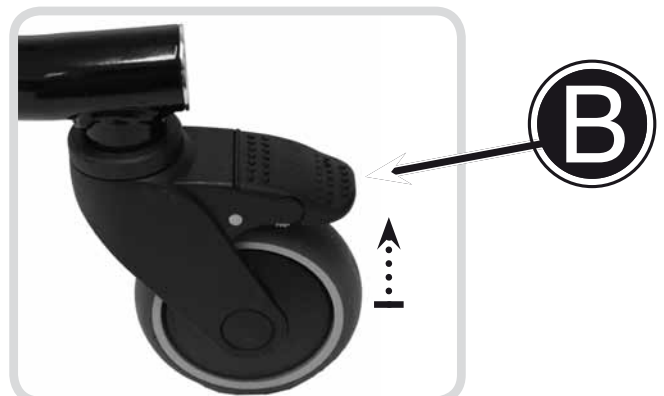

Always apply the brakes while the chair is stationary.

# Important - Chest Harness Adjustment



**GREAT CARE** should be taken when fitting a chest harness and the following points should always be followed:

- The straps on the harness should never be allowed to move close to or in any way cause an obstruction to the child's neck.
- The straps should never be fitted too tightly and should be clear from any obstruction.
- The sternum strap on the chest harness should always be adjusted prior to use to ensure that it is no higher than the middle of the user's chest.
- A lap strap should always be fitted if a harness is being used to ensure the child cannot slide down onto the sternum strap.
- Always ensure that the belts offer your child both comfort and support. If the child's clothing has been adjusted (i.e. a jumper removed) the straps should be re-adjusted accordingly.



## Fixing Onto Chair

The straps at the top of the harness should be attached to the back frame of the chair. The Triton comes with a fixing point either side at the top back of the chair for attachment of straps and harnesses.



The straps at the bottom of the harness should be attached to the buckles located on the underside of the back frame or an alternative location buckle which enables a straight pull of the lower strap.



## Fastening of Belts

- Feed the fabric belt through the buckle on the strap.
- The belts should be pulled through enough to suitably support your child whilst still being comfortable.
- When this has been achieved the buckle should be snapped closed to secure the strap in place.

The same precautions highlighted here should be adhered to when using any form of trunk supports or flexi supports with straps.



If there is any possible chance of the child getting the straps caught around their neck, **REMOVE THE HARNESS IMMEDIATELY.**



# Important - Lap Strap Safety



Incorrect fitting of lap straps can put the user at serious risk. When using lap straps we recommend the following points should always be adhered to:

## Lap Strap Fitting

The angle that the hip belt is attached to the seating system has a direct effect on the angle of pull on the pelvis.

### Considerations:

- A 60° angle of attachment to the seat rail positions the hip belt anterior and inferior to the ASIS, which reduces the tendency of the client with a posterior pelvic tilt to slip underneath the belt.
- A higher angle of attachment of the primary straps encourages a posterior pelvic tilt, which assists in positioning clients with an anterior pelvic tilt.
- The secondary straps of a 4-point hip belt are attached to the seat post between 45° and 90° to hold the primary padded strap in place and to prevent the belt from riding into the abdomen or twisting.
- The angle of attachment may have to be compromised in order to accommodate such situations as wounds in the pelvic area, unstable hip joints or gastric tubes.

## Tightening the belt

Keep belt tightened at adjustment straps during fitting and daily use to ensure correct pad placement. For padded hip belts the pads are to be touching when correctly tightened. For non-padded hip belts the

adjustment strap at the buckle should be approximately 3" (76mm) long. Education of the care giver is essential for correct hip belt positioning.

## Sizing

Measure hip width to determine the belt size required. The suggested method for measuring hip width is from trochanter to trochanter. If this is not possible, measure from ASIS to ASIS and add a couple of inches. The correct belt size for the individual has padding that covers all of the bony prominences.

- Always check that the child's pelvis is symmetrical and positioned securely at the back of the seat.
- Always ensure that the lap straps and chest harness hold the child securely and are comfortable. Ensure they provide a snug fit, a simple rule of thumb is to allow two fingers to be inserted between the belt and the child's body.
- Never leave a child in a chair unattended without the lap strap being fastened.
- A lap strap should always be fitted if a harness is being used.
- When altering the angle between the seat and the back of the chair always re-adjust the chest harness and lap strap accordingly to ensure all safety recommendations are followed.

## Harness and Lap Strap Positioning

This diagram shows the recommended positioning of the chest harness and lap straps:

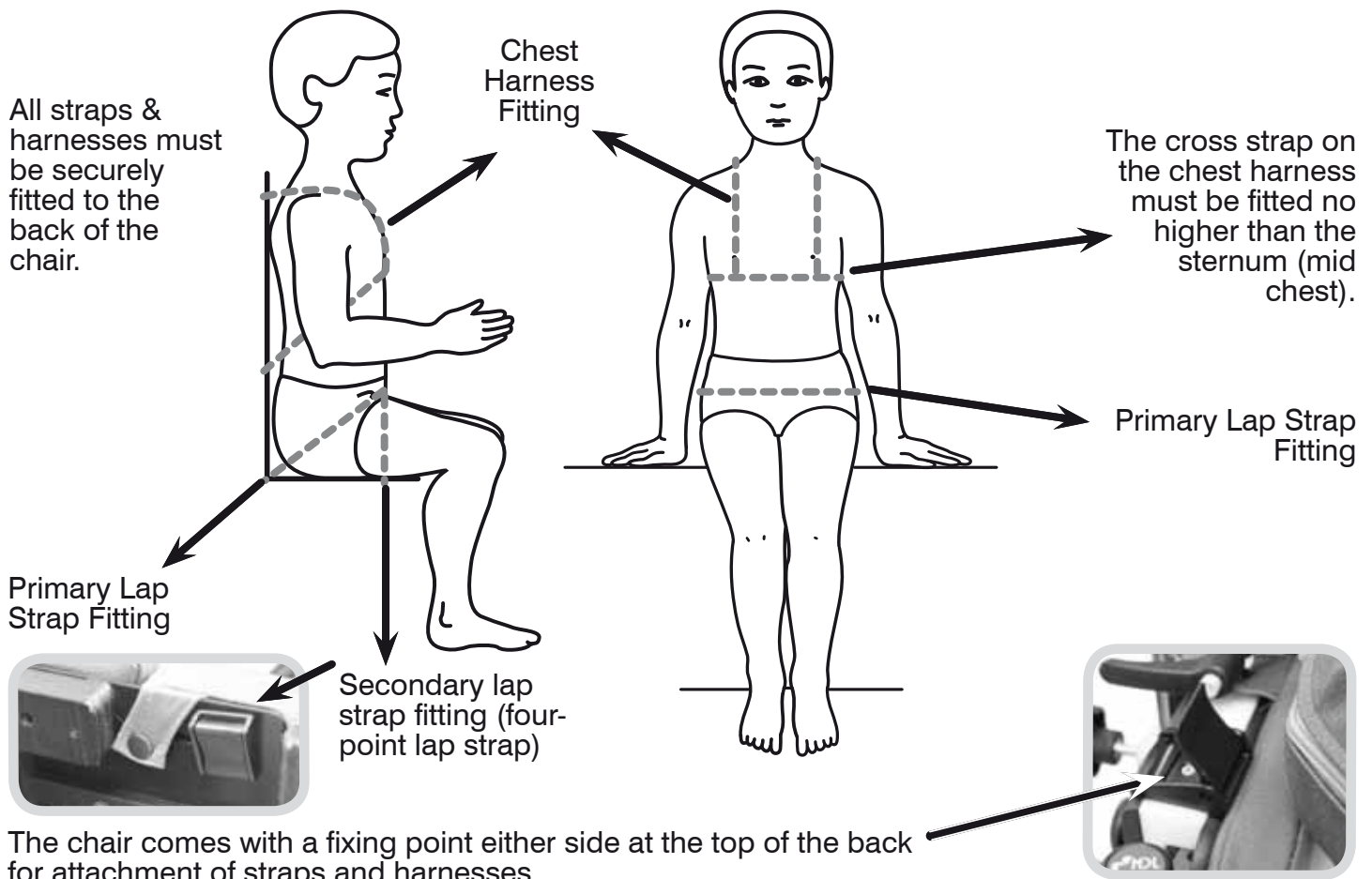

# Useful Info - Adjustment Points & Lever Use

## Adjustments Points Underneath Seat

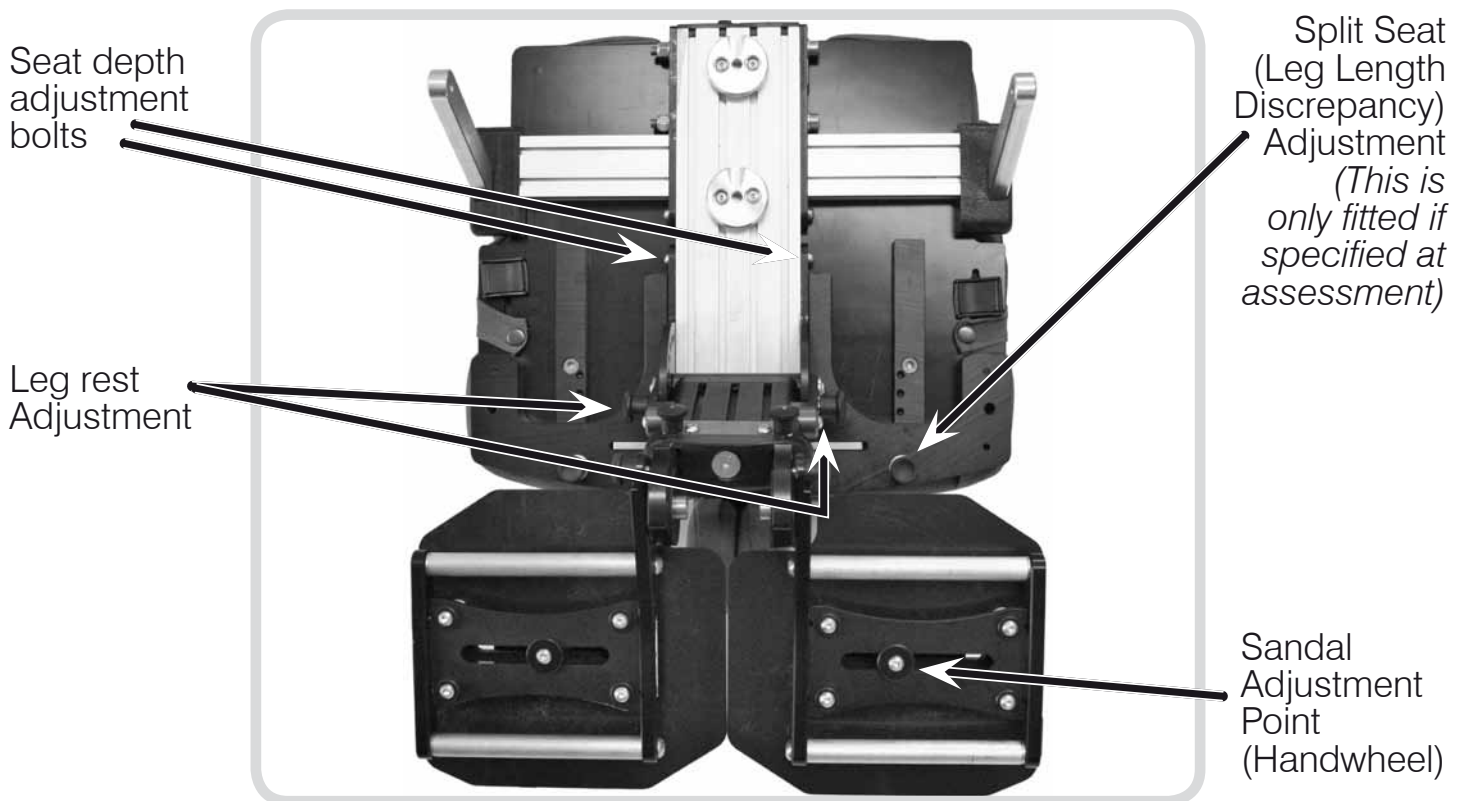

## Effective Operation of Lock Levers (Where Fitted)

Never remove these levers entirely as this will prevent you from being able to perform adjustments in the future.

- **To use:** Turn the lever handle clockwise to tighten or anti clockwise to loosen.
- **To use the lever when an obstruction is met:** Pull the handle of the lever outwards, towards you (A). This disables the function of the lever.
- Continue to hold the lever out and reposition the lever handle in a suitable position past the obstruction.
- Release the handle to re-engage the lever function (B) and continue to tighten or loosen in the normal way.
- Repeat this procedure in areas where adjustment is restricted due to an obstruction.



# Lever Use - Using Index Plungers

## Using the Index Plungers (Locking Variety Only)

- To place the plungers in an open position - Pull out the plungers to maximum tension and turn them through a half turn anti-clockwise (B). This places them in an open position (C).

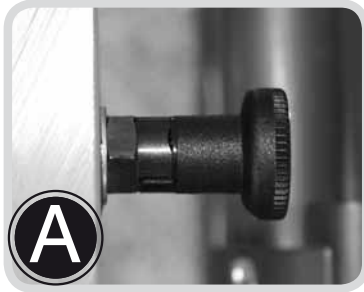

LOCKED

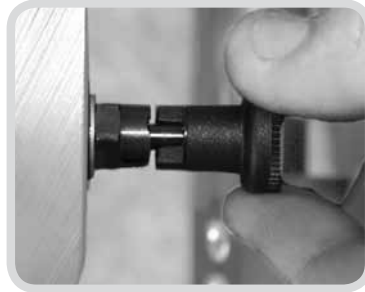

TURN

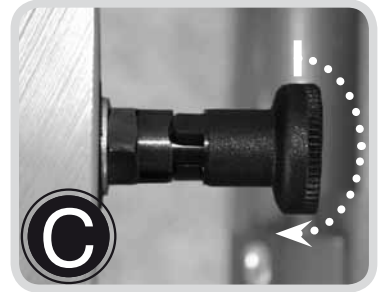

OPEN

- To close - Turn the plungers a half turn clockwise and they should snap back into a locked position (A).

# Adjusting Shoulder Protraction Pads

## Pad Width

- Pull and hold plunger (A) out.
- Manually position the pad to fit the user by sliding the pad in or out.
- Select the desired position and release the plunger ensuring it locates into one of the holes on the pad bar (B).

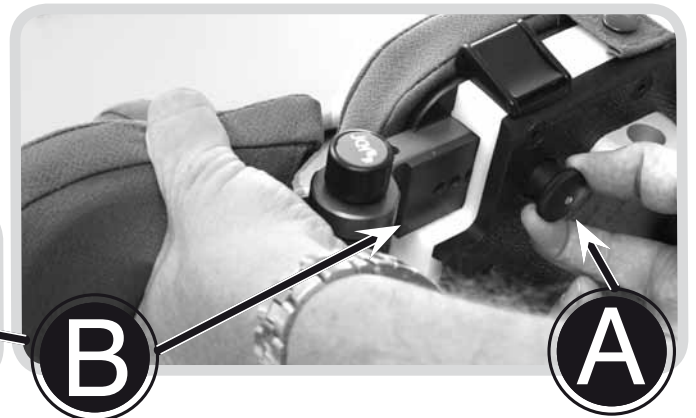
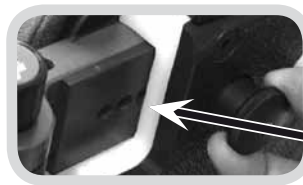

## Pad Angle

- Manually position the pad by pushing towards the front of the chair to give the correct amount of shoulder protraction.
- Depress button (C) and hold down to flip the pad away from the user.
- Release button (C) to secure in place.



The pads can be ratcheted into position, however to maximise the life of the part, it is recommended that the release button is used to bring the protractor into the desired alignment.

# Mounting of Seating Unit



Always ensure the base is stable and that the brakes are applied before mounting the seating unit.



Please note that the handle fitted is dependent on the size of the chair. You therefore need to ensure the size label on the handle matches the size of the chair being used.

- There are 2 cut outs on the top of the interface plate (A) which are for locating lugs (B) on the seating unit to fit into.



- Position the seating unit above the interface plate, lining up the locating lugs (B) with the cut outs (A) on the interface plate.
- Carefully lower the seat onto the interface plate ensuring the locating lugs (B) slide into the cut

outs on the interface plate (A).

- Push the seating unit inwards towards the back of the chair until the locating lugs 'click' into place.
- Ensure the seat is securely located on the base before using.



*View from the side showing the seating unit lugs lowering into the interface plate cut outs.*



*View of seat engaged with the base.*



Always ensure that the locating lugs are fully engaged and that seat is securely locked in place and secure on the base before using.



When mounting the seating system to a base for the first time, or when an adjustment has been made to the size of the system, a stability assessment should be carried out prior to use of the equipment.

# Removal of Seating Unit

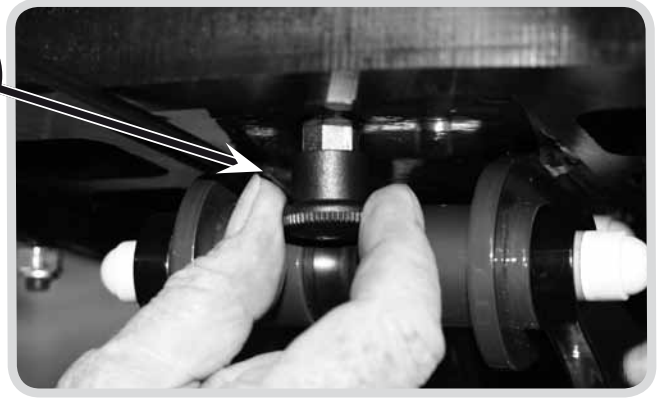
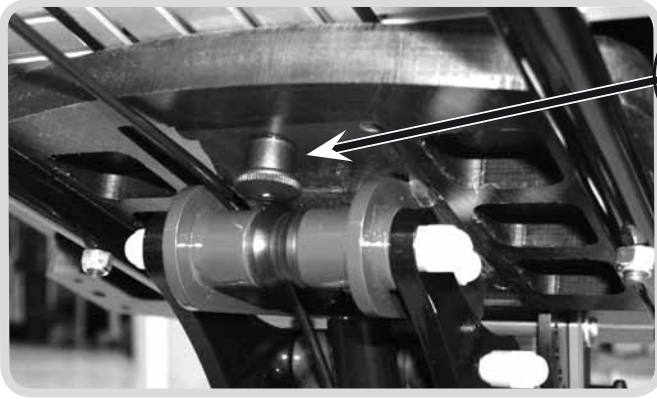

- Release index plunger (C) which is underneath the interface plate and slide seat forward to remove it from the base.

# Manual Seat Height Adjustment (Multi Height & Tilt Base)

The multi height and tilt base caters for all sizes of Triton. It is controlled by a hydraulic pump mechanism.

## To Raise The Chair

- Pump the foot pedal several times until the desired height is reached. (The chair will raise with each pump.)

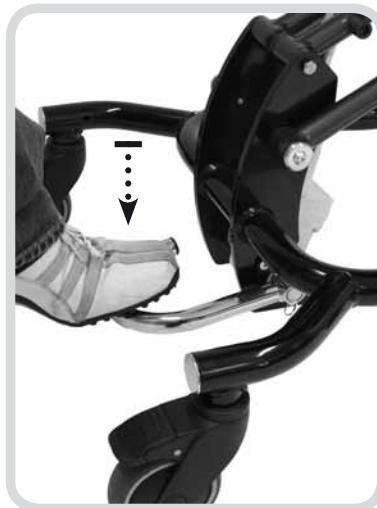

RAISE  
Pump down on pedal

## To Lower The Chair

- Place your foot under the pedal and gently lift the pedal up. (The chair will automatically lower.)



LOWER  
Lift pedal up with foot

# Powered Base Height Adjustment (upgrade option)

Button A

Up

Button B

Down

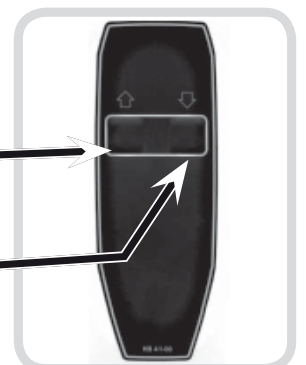

Always ensure that adjustment mechanism is free from obstruction before operating this chair.

## Tilt In Space (Multi Height & Tilt Base)



Always ensure the base is stable and that the brakes are applied before performing the following adjustments.

**A**

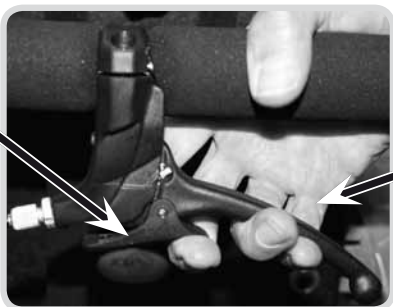

**B**



- Release the locking mechanism on the handle by squeezing the small latch (A) up on the handle.

- **To Recline:**

Use one hand to squeeze handle (B) and push down the chair handle, at the same time use the other hand positioned on the chair arm or side to help guide the chair into the recline position.

- **To put into Prone:**

Squeeze handle (B) and pull the chair handle upwards and forwards. at the same time use the other hand positioned on the chair arm or side to help guide the chair into the prone position.

- Once in position release handle (B) to lock the tilt mechanism.



- Ensure that the latch (A) on the handle moves back into a closed position, this ensures the tilt position is locked in place.



The operator should control the motion of the chair while the squeeze handle is engaged. The amount of support required will vary with the size and weight of the user. We recommend practicing this operation on first use before placing the client in the chair.

## Folding Push Handle (Multi Height & Tilt Base)

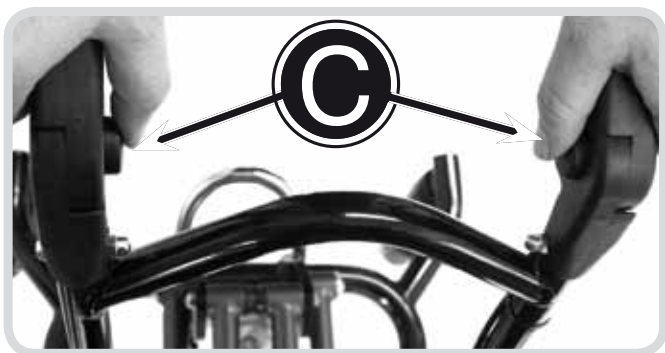

Only use the push handle to move the chair. The push handle should be folded down when not in use.

- Depress both buttons (C) on the inside of the handle.

- Manually alter the position of the handle by pushing the top section down.

- To unfold pull the handle up until you hear a click ensuring it is in place.



# 5 Star Base Adjustments



Always ensure the base is stable and that the brakes are applied before performing the following adjustments.

## To Raise The Chair

- Located at the back of the chair beneath the base locate the handle (A) and continuously push down to raise the height.
- The seat height will raise with additional assistance required, dependent upon the weight of the user.
- Release the handle when the desired height is achieved.

## To Lower The Chair

Use the handle (A) again but this time apply pressure to the top of the seat with one hand whilst pushing down handle (A).

If you find performing these actions difficult to do simultaneously on your own please get another person to help you.

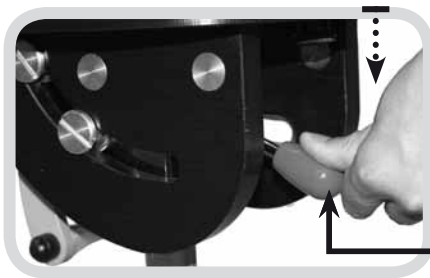

## To Perform the Tilt in Space on the 5 Star Base

- Lift safety latch (B) up to prepare the base for the tilt adjustment.
- Lift operation latch (C) up until it stops, disengaging bar (D).
- Tilt the base interface to the desired angle.
- The adjustment range can be seen via the groove at the side of the seat base.
- When the desired angle has been achieved. Close operation latch (C) by pushing down until it bar (D) locates securely into a set position groove (F).
- Push down safety latch (B) to prevent accidental operation of the tilt in space.
- Always ensure that the groove on the safety latch (B) is securely located onto the bar (D) to secure the seat into place.

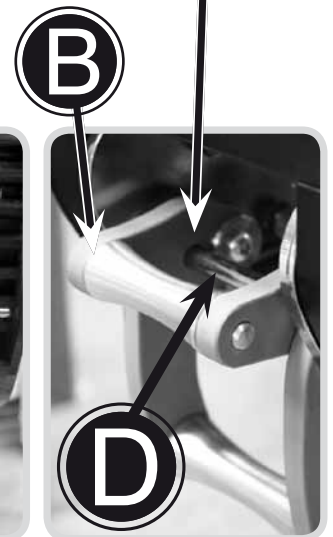
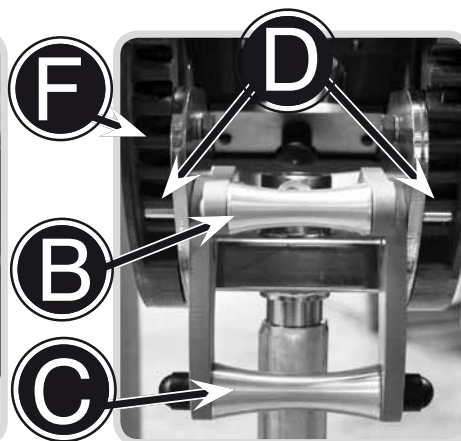
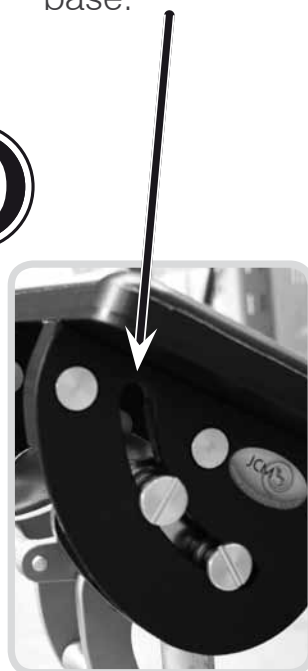
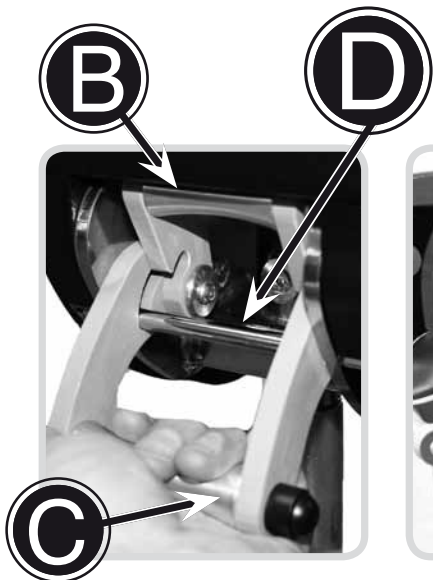

# Back Angle Adjustment

- At the lower back of the chair squeeze together levers (A), this releases them from their holding position in holes (B).
- Whilst holding the levers together, hold the chair by the top of the back and guide the angle of the back into the required position.
- Relocate the levers into the relevant positioning holes (B) to secure the back in place.
- Always ensure that the back is secure and that the levers are located fully in a hole before using the chair.

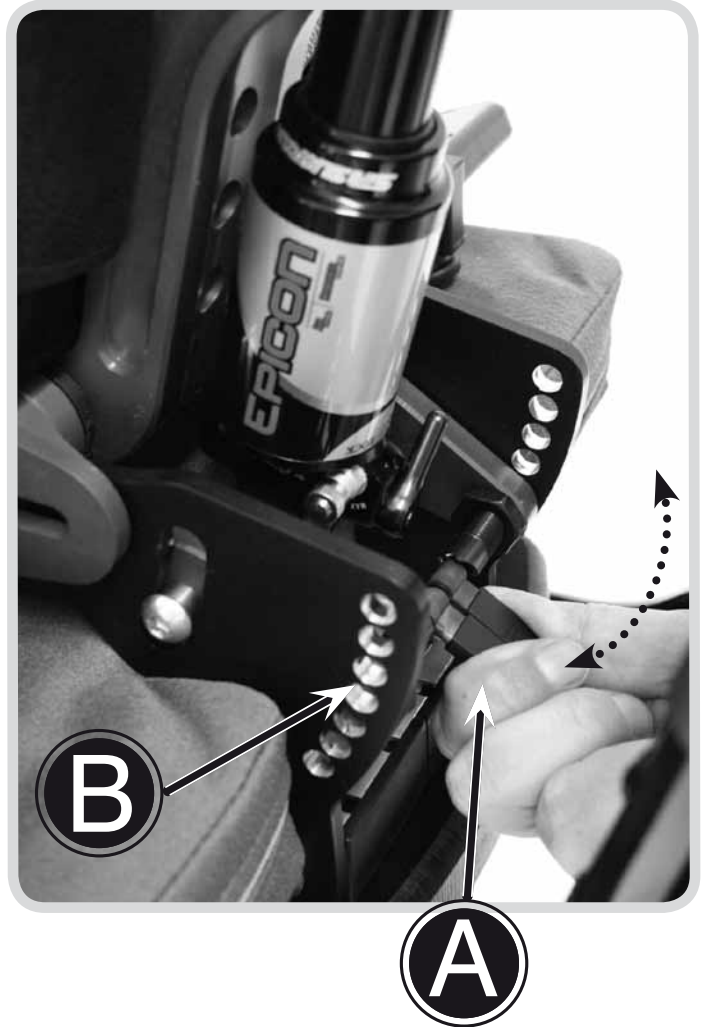

# Back Height Adjustment - Dynamic

- Remove the back pad cushion which is held in place by press studs.
- Loosen the two allen key bolts (A) on the plastic back panel.
- Slide the plastic panel up or down to the desired height.
- Tighten the two allen key bolts securely.
- Replace the back cushion pad.

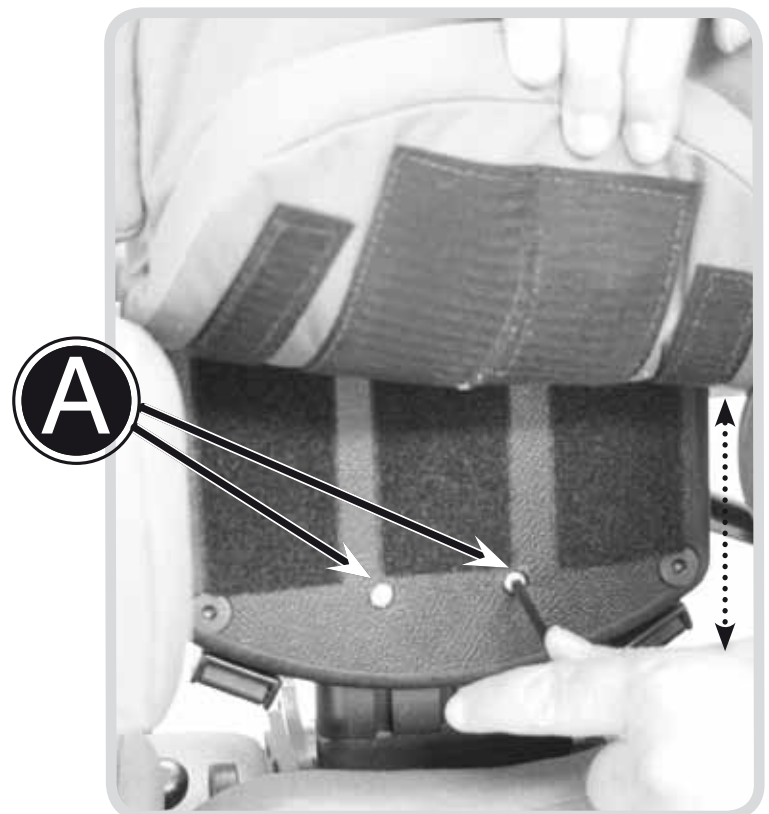

## Note

The picture shows the Dynamix model of the Triton chair.

The Custom model has hand wheels on the back of the chair.



# Adjusting Seat Depth

- Loosen (do not remove) the allen key bolts (A) on both sides of the seat.
- Slide the seat in or out to change the length.
- Fix the position by tightening the allen key bolts securely.

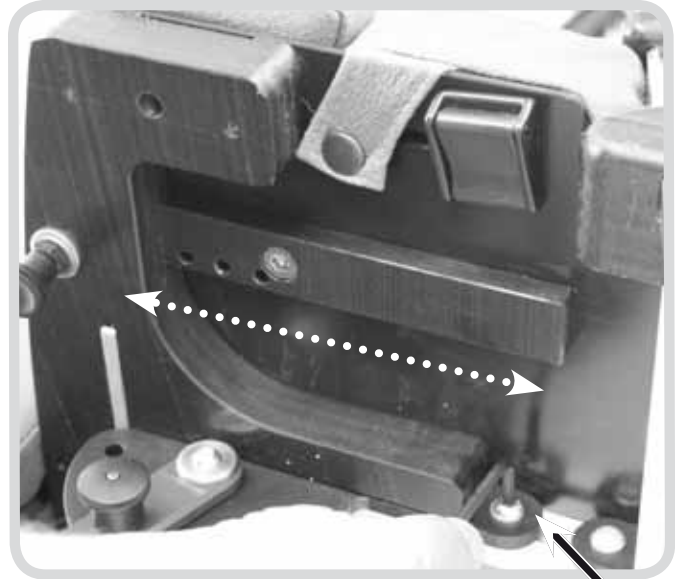

When mounting the seating system to a base for the first time, or when an adjustment has been made to the size of the system, a stability assessment should be carried out prior to use of the equipment.



Once you have adjusted the seat length, always ensure these points are firmly fixed and are checked as part of maintenance of the chair.

## Split Seat Adjustment (Leg Length Discrepancy)

*(Where fitted if specified on assessment)*

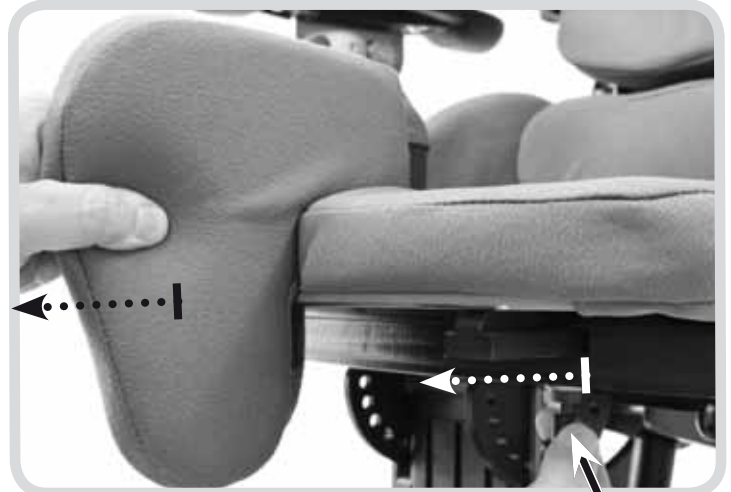

The leg length discrepancy is adjusted by altering the 2 split seat pads either side of the front of the seat (as shown above).

- To adjust seat length pull and hold out plunger (A)
- Whilst holding the plunger out manually adjust the seat pad by pulling the abduction pad out (away from) or in (towards) the seat.
- Release the plunger and ensure it is securely relocated into one of the positioning holes beneath the seat (B).



# Fitting a Tray

- Line up the arms of the tray with the holes on the arms of the chair (A)



- Slide the arms of the tray through the holes until the desired position is reached.

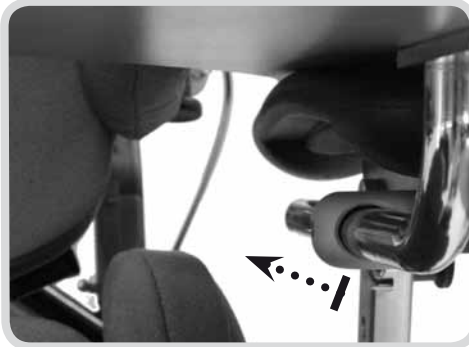

- Secure the tray in place with the hand wheel at the side of the chair arm.



Always ensure that the arms are fixed in position and the tray is secure before leaving the user unattended. Never leave anything hot on the tray while the client is unattended.

# Sacral Pad Adjustment

## Pad Height

- Pull the cushioned pad away from the framework
- Loosen the allen key bolts (A) on both sides of the sacral pad (2 altogether).
- Move the pad up or down within the adjustment slot.
- Once in place tighten the bolts to secure.

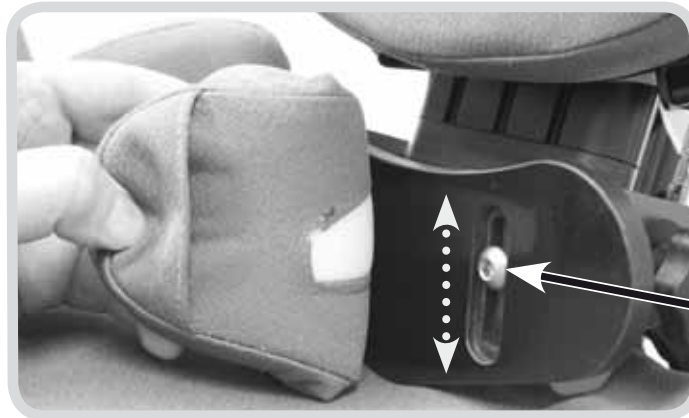

## Pad Angle & Depth

- Loosen hand wheel (B) gently tilt the pad up or down and move forward or back to create the desired lumbar curve in the lower back.
- Once in place securely tighten the hand wheel.



# Hip Pad Adjustment

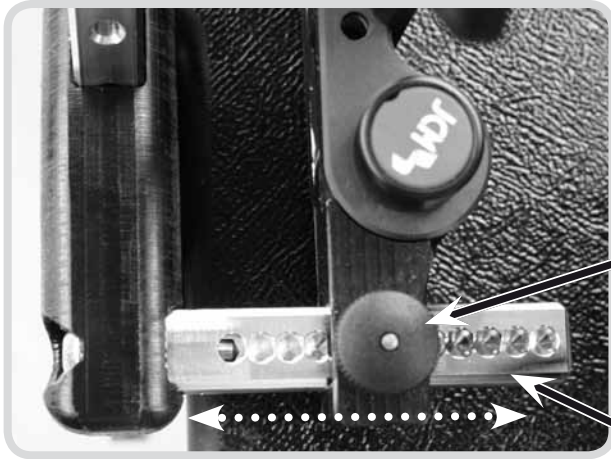

A

B



C

## Hip Pad Width

- Whilst holding plunger (A) up adjust the hip pad along the hip pad bar (B).
- Relocate the plunger into one of the relevant positioning holes on the hip pad bar (B).

## Hip Pad Angle (Where Fitted)

- Push down button (C).
- Manually adjust the pad to the desired angle.
- Release the button (C) to secure.



The pads can be ratcheted into position, however to maximise the life of the part, it is recommended that the release button is used to bring the hip pad into the desired alignment.

# Thigh Pad Adjustment

These pads enable you to sit the client in an abducted position which can help to lower muscle tone, create a wider sitting base and maintain the hips in a good position.

- Lift seat pad cushion
- Loosen both bolts (A) with the allen key provided.
- Manually adjust the pads position by pulling the pads away from each other or pushing them together along the slot (B).
- Fix in place by tightening bolts (A) by turning clockwise.

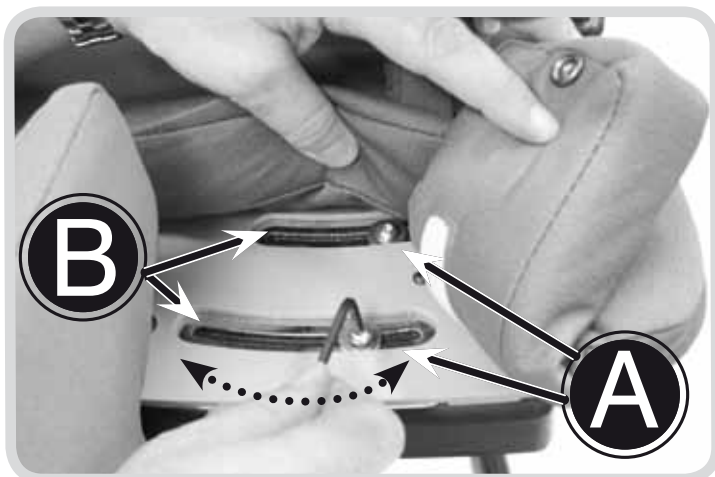

B

A



# Headrest Adjustment

## Adjusting the Wing Angle

This adjustment point allows you to move the wing position to offer more side support to the head. This adjustment point allows you to alter the angle of the headrest to support the head and neck.

- Unzip the headrest cover at the back and loosen the allen key bolts (A).
- Adjust the sides of the headrest into the desired position.
- After desired position has been reached tighten the bolts to secure in place.

Perform this for either side wing of the headrest.

## Adjusting the Headrest Angle

- Levers (B) should be operated together to achieve the desired head positioning of the user. Loosen the levers by turning anti-clockwise.
- Once loose, the head support angle can be manually adjusted to suit the user.
- Tighten the levers to secure in place.

## Adjusting the Headrest Height

- Loosen the hand wheel (C)
- Slide the headrest up or down inside the bracket on the back of the chair.
- Re tighten the hand wheel to secure in place.

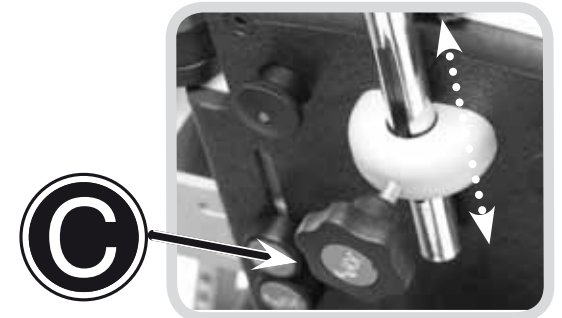
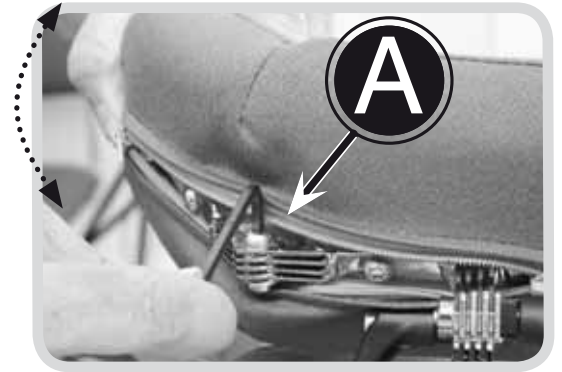

Always check that the headrest is secure and the wings are not tight around the head. The headrest wings are ideally set at 45 degrees to the back.

# Long Sitting Pad Adjustment

Whilst holding plunger (A) open, pull the long sitting pad forwards away fully from the chair to remove.

To extend / shorten relocate the plunger into another of the positioning holes (B) underneath the sitting pad.

Ensure that the plunger is fully locked in place into one of the holes before use.

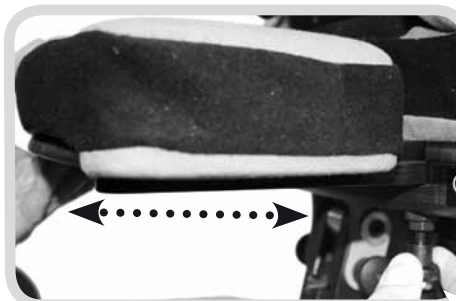

# Lateral Support Adjustment

## Height & Width of Supports

- Loosen both bolts (A) using the allen key provided.
- Slide the pads up or down along the slot in the seat back (B) to adjust the height.
- Slide the pads horizontally along the slot (C) to adjust the width.
- Re-tighten the allen key bolts to secure.

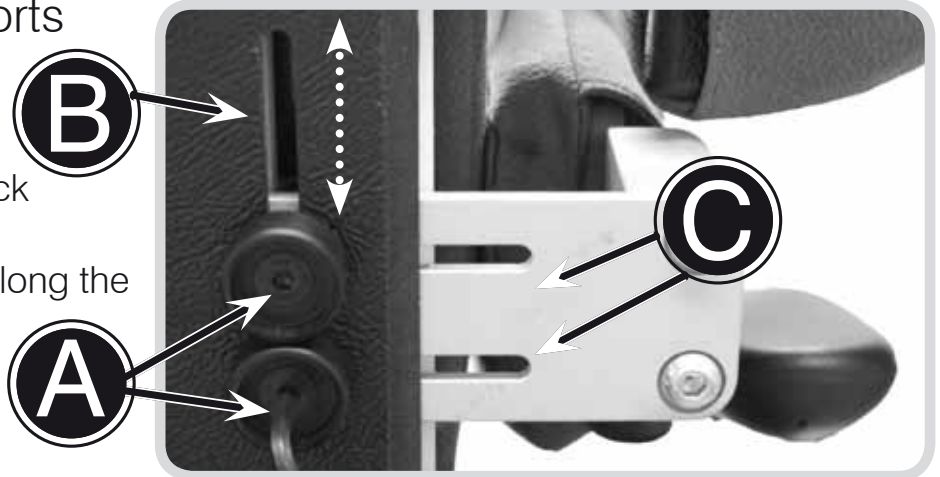

## Flip Away Action

(Where Fitted)

- Pull plunger (D) downwards.
- Flip the supports away to aid transfer or set up.
- When ready push the supports back in, until they lock in place.

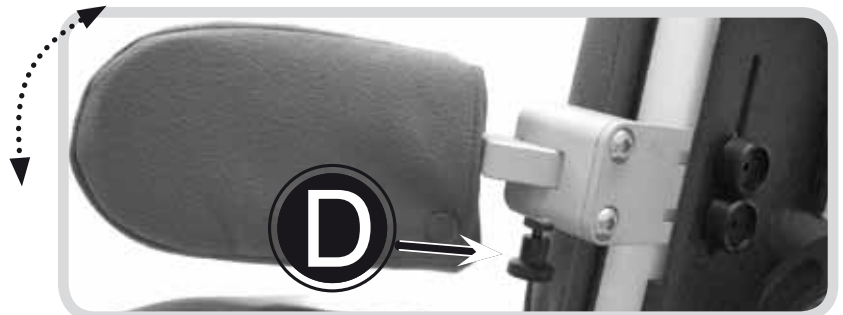

Check that the supports are not too high under the arms of the user or tight around chest area by running your fingers around the inside of the supports. Also check that the supports do not infringe on any feeding tubes.

# Pommel Adjustment

## Pommel Height

Note: The height adjustment is used for removing the pommel or adjusting accordingly to the height of the chair cushion.

- Whilst holding out plunger (A) adjust the height by sliding the metal mount pole up or down and locate the plunger in the relevant hole on the bar (B). Always ensure the plungers are locked securely in place, before use.

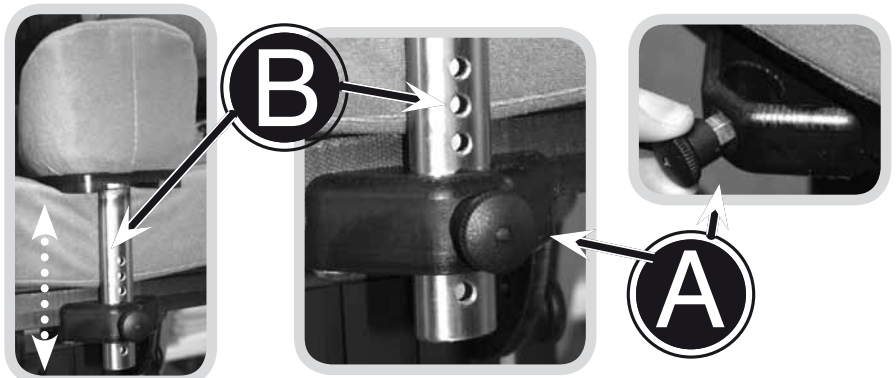

## Forward and Backward

- The pommel position forward and back can be adjusted by un-tightening the screw on the metal mounting with the 4mm allen key provided and sliding the pommel pad along the slot in the metal pommel bracket.
- For an increased adjustment you can remove the pad from the metal bracket completely, re-locating the metal bracket 180 degrees to its original position and then re-fit the pad back onto the bracket accordingly.



Ensure you re-tighten the allen key bolt when the metal pole is in place.

# Arm Rest Positioning

## Adjusting Arm Height

(A) highlights the plunger which is used to adjust the height of the arms and therefore in turn the height of the tray.

- Pull plunger (A) outwards away from the arm, and while holding the lever open slide the arm up or down, selecting one of the holes shown (B) to reposition.
- When a suitable position has been acquired, lock the arm into place by releasing the lever, ensuring it fits securely back in place.



## Adjusting Arm Angle

The arms fitted to your Triton chair can be altered to sit throughout an angle range, enabling the user to level their tray no matter what tilt the chair is secured at.

- Pull plunger (C) outwards away from the arm.
- While holding the lever open, tilt the arm up or down to achieve the angle required.
- When a suitable position has been acquired, lock the arm into place by releasing the lever, ensuring it fits securely back in place.



The plunger (C) should pull out freely, if resistance is felt ensure no weight is being put through the arm rest.



Always ensure that the arms of the chair are secure before using the chair.

# Leg Rest Angle Adjustment

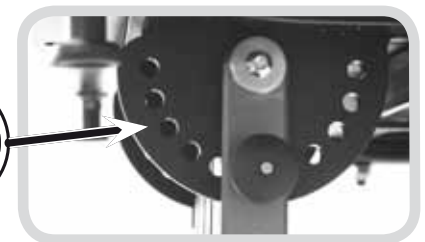
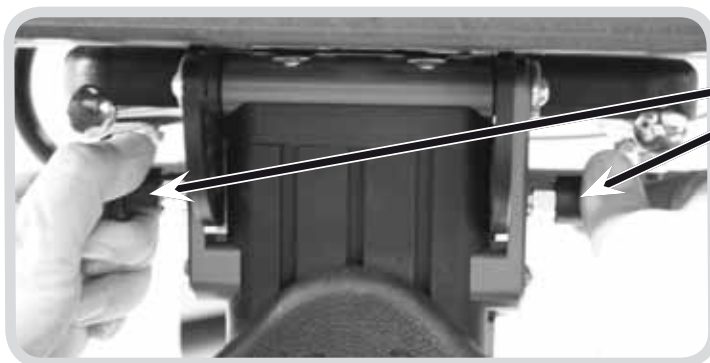

- Pull out both plungers (A) on either side of the leg rest.
- Manually adjust the legrest to the desired angle.

- Relocate both plungers into one of the positioning holes (B).
- Ensure the plungers are securely located in position.

# Footrest, Footplate & Sandal Adjustment

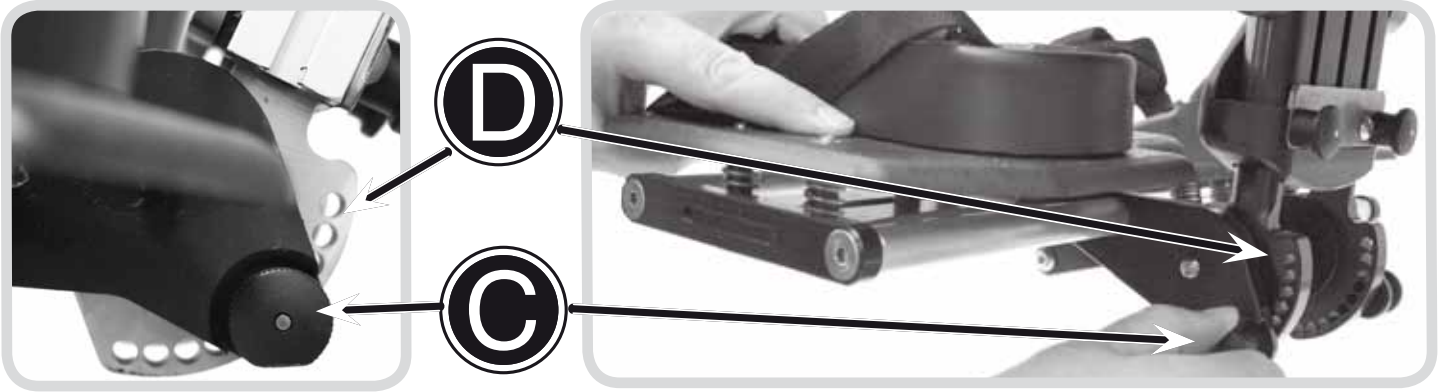

## Footrest Angle Adjustment

- Pull out and hold plunger (C).
- Manually tilt footplate to desired angle.

- Relocate the plunger into one of the positioning holes (D) at the back of the footplate.



The plungers (C and E) should pull out freely, if resistance is felt ensure no weight is being put through the footrest.

## Footplate Height

- Ensure footplate lock bolt (below) is untightened.
- Pull out and hold plunger (E).
- Slide the footplate to the desired height.
- Release plunger relocating into one of the holes (F).

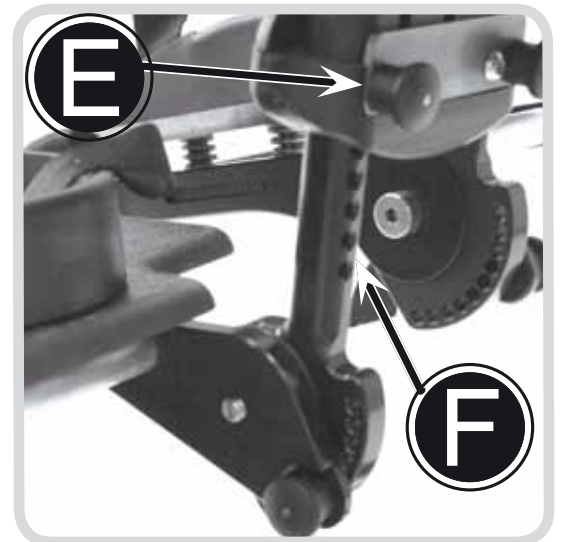

## Locking Off Footplate

As an optional feature the footplate can be locked off completely. To do this tighten the bolt shown

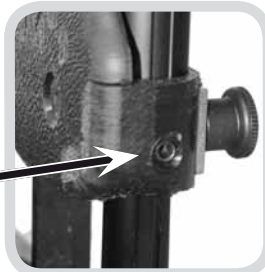

with the allen key provided. **DO NOT OVER-TIGHTEN**

## Sandal Rotation

- Underneath the footplate loosen the central allen key bolt turning anti-clockwise.
- Rotate the sandal to the desired position along slot (G).
- Fix in place by tightening the allen key bolt beneath the footplate.

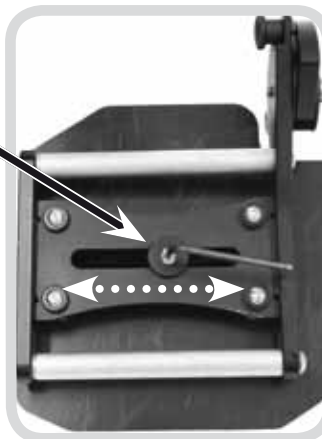

## Foot Straps

Foot straps or ankle huggers can be attached through the slots in the sandal to secure feet. Feed the strap through the buckle and close the buckle shut to secure.



Do not use foot straps unless the client is wearing shoes.

# Setting Up the Dynamic Back Mechanism



**Never modify your shock system. Modification, improper service or use of non-SR SUNTOUR spare parts voids the warranty and could cause a malfunction resulting in serious injury.**

**Follow the maintenance schedule, if the shock system shows any malfunctions such as losing oil, making unusual sounds or any part is bent or broken, cease use of the seating system immediately and contact JCM for assistance.**

**Never try to open or disassemble the shock system. Opening the shock system could cause serious injury.**

## Setting the Strength of Resistance & Power of Return

For maximum performance and comfort, it is necessary to adjust the strength of resistance and power of return of the dynamic mechanism. The resistance is adjusted by varying the air pressure and should be determined by the user's weight, seating position, seat design and personal preference.

The air pressure is adjusted with a standard schrader valve shock system pump (A) on the main air valve of the dynamic mechanism.



## Strong Resistance - Increasing the Air Pressure

The shock system is more difficult to compress during use. The seat back feels firmer when pushed against.

- Attach the pump to the air valve on the back of the dynamic mechanism (B).
- Pump air into the valve to increase pressure.
- Watch the pressure valve dial on the pump to determine the amount of pressure added.

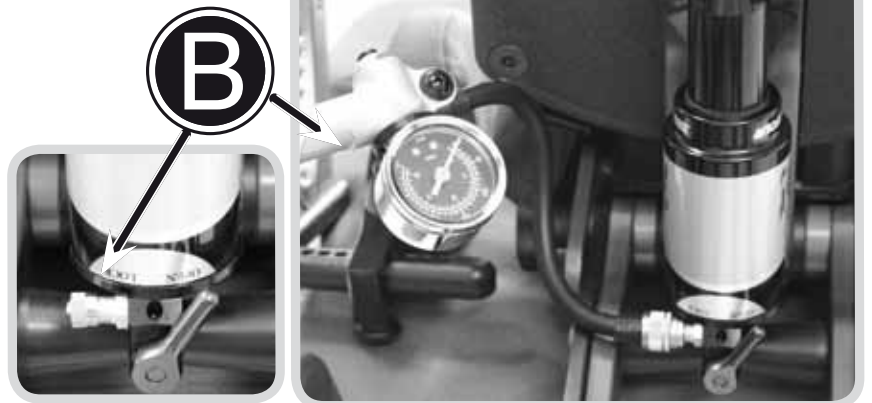

## Weak Resistance - Decreasing the Air Pressure

Makes the shock system compress more easily. The seat back feels softer when pushed against.

- Press button (C) on the pump and keep depressed until the air pressure resistance achieves required level.

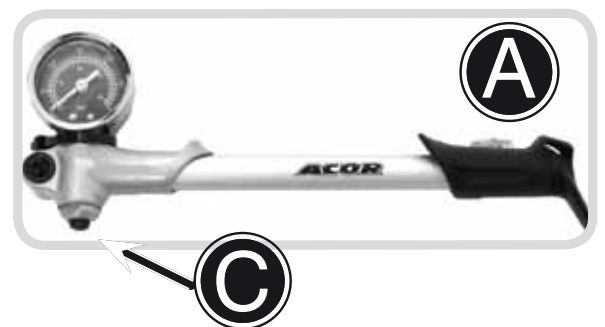

**The pressure range is 50-250psi. Never exceed an air pressure of 250psi in the uncompressed shock system. Exceeding the maximum air pressure of 250lbs/inch could result in serious injury.**



## Setting the Power of Return

The power of return controls the rate at which the shock system decompresses or rebounds. The amount of return strength needed depends on the user's weight, the spring rate which is set by the air pressure, the amount of use, the sitting style and personal preferences.

The best way to adjust the return strength is to decrease it completely by turning the red adjuster wheel (D) clockwise (labelled slow) and test by placing the user in the seat. Increase the damping by slowly turning the wheel counter clockwise (labelled fast) until the user feels comfortable and safe without the suspension kicking the user too far forward.



## Disengaging the Mechanism

Occasionally at meal times etc it is necessary to disengage the dynamic mechanism. To do this:

- Lock the system by switching the lever from the "open" to "locked" position on the lever on the shock system.
- The mechanism should not be left in the 'locked' position as part of normal use. You should ensure the mechanism is returned to the 'open' position once the activity demanding the lock out has been completed.



## Maintenance Schedule:

The rear shock systems need a minimum of maintenance only:

- Use water and soap only to clean the system - never use a high pressure washer or any water under pressure to clean the shock system as water may enter the system.

## Before every use:

- Check air pressure (it is normal for the shock system to lose air pressure slightly over time) - Check to ensure it is appropriately set for your client.
- Adjust power of return set up to ensure it is set appropriately for your client.

The extensive service of the shock system internals must only be done by an authorized technician.



### WARNING!

Please note that your SR SUNTOUR rear shock is filled with oil and nitrogen. This makes it impossible to open the rear shock without having the knowledge and special tools required to carry out this task. Please do not try to open the rear shock for service issues, this implies a very high risk of getting seriously injured. Besides this you will not be able to reassemble the shock any more. Opening the shock will void its warranty.

If there is a problem with your rear shock, cease use of your chair immediately and contact JCM Seating Solutions.

# Cleaning & Care

We recommend the following points for successful cleaning of your equipment. (It is possible that some surface wrinkling may occur following these processes)

## Fabric Upholstery Care

Refer to JCMs separate fabric cleaning guide which can be found on their website [www.jcmseating.co.uk](http://www.jcmseating.co.uk) or in hardcopy format from the JCM office. Do not use bleach, acidic, solvent, abrasive, biological or phenolic based cleaners.

## Metal Framework

- If all upholstery is removed the metal framework can be cleaned with hot soapy water and detergent or it can be steam cleaned. (Labelling may need to be replaced following steam cleaning).
- Ensure that the framework is thoroughly dried after cleaning.
- Always ensure that any moving or adjustable parts are re-lubricated.

# General Maintenance



General maintenance should be carried out by a competent, professional person who is well informed on how to use the equipment (see warranty - page 29) if there is no such person available or a more thorough check is needed, a service via an approved repairer (see opposite) should be booked. The person who carries out the maintenance check or service should always fill out the service history log record (page 28) in order to ensure the warranty remains valid.

As documented opposite, the degree of maintenance required is dependant on various factors relating to the use of the product. In addition to the specific functional adjustment warnings specified in this manual, it should be ensured that a thorough inspection of the following should be completed at no greater than 6 month intervals: (Points listed here are generic across the JCM range and do not apply to all products).

Castors	<ul style="list-style-type: none"> <li>• Lift base and check each wheel to ensure it is not damaged, loose or worn.</li> </ul>
Brakes	<ul style="list-style-type: none"> <li>• Removing any grease or dirt that has built up on the wheels, check that the brakes stop the wheels rotating.</li> <li>• Check they are securely fixed in place &amp; that there are no signs of damage or wear &amp; tear.</li> </ul>
Pushing Handles	<ul style="list-style-type: none"> <li>• Ensure handles are functioning correctly.</li> <li>• Check there are no signs of damage or wear and tear.</li> <li>• Ensure push handle grips are secure.</li> </ul>
Seat Tilt In Space Mechanism	<ul style="list-style-type: none"> <li>• With the tilt lock released check for free movement with no signs of damage or wear to the mechanism, lever or cables.</li> <li>• Tighten the lock and ensure it holds the seat angle.</li> </ul>
Base Height Adjustment	<ul style="list-style-type: none"> <li>• With the seat unloaded, press the lever &amp; ensure it moves freely to the maximum height.</li> <li>• In incremental stages add weight up to the maximum load (40, 60, 80 or 100kgs) and, over a period of time (approx 10 - 15 minutes), check that there is no creep (lowering) of the seat. If it is not practical to perform this test, as a minimum requirement, immediately following the maintenance check, the static position of the seat should be monitored whilst a user is positioned in the system.</li> <li>• With the load on, press the lever &amp; ensure the seat travels freely to the lowest position.</li> </ul>
Seat / Backrest Upholstery	<ul style="list-style-type: none"> <li>• Check the attachment points of the seat and backrest upholstery are tight.</li> <li>• Check for worn covering. Rough worn upholstery can cause discomfort, would be difficult to keep hygienically clean, and may cause skin irritation.</li> </ul>
Interface	<ul style="list-style-type: none"> <li>• Check there are no signs of damage or wear and tear.</li> <li>• Ensure the function secures the seating unit properly.</li> </ul>
Frame With correct maintenance the frame should provide at least 5 years trouble free use but, depending on conditions of use, wear will occur and a thorough inspection is recommended.	<ul style="list-style-type: none"> <li>• Check all metal parts to ensure there are no signs of damage or wear and tear, paying particular attention to adjustable or moving parts.</li> <li>• Check there are no signs of failure in joints and welds.</li> <li>• Check tightness &amp; security of all fixings, bolts, nuts, spring loaded pegs, &amp; other fitments.</li> <li>• Check for signs of fatigue wears, replace parts that show signs of wear or repeatedly becoming loose.</li> <li>• ANCHOR POINTS (where applicable) for transportation must be checked to ensure security, check there are no signs of damage, wear and tear or failure.</li> </ul>
Fixtures	<ul style="list-style-type: none"> <li>• Check arm pads and headrest and replace if worn.</li> </ul>

# Servicing via Approved Repairer

## What should be completed during a service?

A service is a comprehensive combination of inspection, maintenance and repair or replacement of worn, faulty or missing components. The growth and any changes of the occupants needs since the original assessment is taken into account when performing the service. This is in contrast to general maintenance (opposite), where only straightforward checks, inspections and adjustments take place and primary services are planned.

## What happens if a fault is found?

If any faults are found that could prove to be a risk to either the user or the operator then all use of the equipment should be ceased immediately until the product has been repaired.

## Who should carry out the service?

It is stressed that only a JCM approved repairer or a person with competent training of a Class 1 medical device should carry out this work.

Any modifications must not be carried out without prior agreement of JCM Seating Solutions Ltd. It must be understood that unauthorised modifications may pose a risk to users and attendants. Unauthorised modifications will also invalidate the warranty.

Any new parts required should be genuine JCM Seating Solutions Ltd. approved parts, fitted to JCM specifications.

## Frequency of Service

JCM recommend that a service of this product is completed once every 6 months as a minimum. However, the frequency of inspection and service must be altered depending upon the severity of use. If the system is used in any of the following ways then the use could be said to be fairly heavy and constant. Therefore we would recommend the service interval be reduced to once every three months;

- Daily for around 8 to 10 hours.
- Weekly for at least 6 days out of 7.
- Monthly for at least 11 months a year.
- By an active user or somebody who is very active voluntarily or involuntarily.
- By a user who is above 80% of the maximum user weight recommended.
- Transported in a moving vehicle twice or more in a day.

If the usage exceeds the amount highlighted above it is possible that services every six weeks or less might be needed.

## How To Book A Service

JCM have specified technicians trained to service our products. If you would like JCM to service your chair or for further information please contact us on 01733 405830.

Alternatively, contact the person who issued you with the product.

# Service Record Log

This log is an important record of usage and care of the product. It is a primary tool in predicting the need for further service and maintenance. It should be completed each time an inspection, service or any other significant manipulation has taken place. **JCM Seating Solutions Ltd. will require proof of service for any warranty claims or orders.**

Seating system serial number \_\_\_\_\_  
Date delivered \_\_\_\_\_/\_\_\_\_\_/\_\_\_\_\_  
Battery use by date \_\_\_\_\_/\_\_\_\_\_/\_\_\_\_\_

Date	Service Performed	Organisation	Print Name & Sign

Please contact JCM if additional log sheets are required.

# Warranty

## 3 YEAR WARRANTY

Products manufactured by JCM are covered with a manufacturers 3 year warranty.

### What it Covers

The warranty covers all aspects of product failure due to faulty workmanship or manufacturing.

### Period of Cover

The period of the warranty runs for 3 years from the date that the product is dispatched.

### The Work JCM is Obligated to Complete

JCM's obligation under this warranty is to replace or repair any defective goods within the period of the warranty free of charge.

### What the Warranty Does Not Cover

- Items that are damaged or fail due to natural wear and tear, extreme usage, neglect or misuse.
- Accidental damage, modifications or repairs carried out by a third party unauthorized by JCM or non professional healthcare representative.

### Customer Responsibility

To ensure the warranty remains valid, customers are advised that servicing, maintenance and re-issuing guidelines must be followed and documented as stated in the manual.

JCM will require proof of service (see opposite) for any warranty claims or orders.

When making a claim JCM reserve the right to inspect the product and all necessary documentation.

Only valid for products purchased after 1st April 2006. Applies only to products exclusively manufactured by JCM.



3 YEAR WARRANTY

## IMPORTANT

JCM Seating Solutions Ltd. will not be held responsible for any damage or injury caused by incorrect use of this product. For any information or guidance on the use of this product please call our office who will put you through to your local representative or send you any additional information you may require.

**Tel: 01733 405830**

# Inspecting & Reissuing of Equipment

Most JCM Seating Solutions Ltd. products are individually assessed for a client prior to issue. They are handed over in a controlled way to ensure optimum fit and specification, checks are completed and any additional individual verbal instructions given. We therefore recommend the following points are adhered to prior to any re-issue of equipment:

- **Cleaning**

Follow a rigorous process of cleaning in order to decontaminate the product and eliminate the chance of cross infection.

- **Assessment of Fabrics / Foams**

Carefully assess the condition of fabrics and foams in the seating product, and have these replaced partially or even completely if need be. In severe cases if the chassis is worn and the seating in poor condition it may be necessary to have the product re-furnished by the manufacturer. In very severe cases if the chassis is badly worn and the seating in very poor condition then the product should be decommissioned and disposed of.

- **Electrical and Electronic Equipment Decommissioning**

If your product is set up with an electrical function you should always contact JCM or your authorised representative for de-commissioning information.

- **Appropriateness of Equipment**

Check that the equipment supplied is appropriate for the needs of the user taking age, weight, ability, diagnosis, and any other important factors into account. For instance, JCM Seating Solutions Ltd. products may not be suitable for persons with severe challenging patterns of behaviour. Also ensure safe specified limits for use are not exceeded by the new user. Your sales representative can advise on the suitability of the equipment.

- **Manuals and Records**

Ensure this instruction manual and any additional manuals for the seating unit are handed over to the new user with the equipment and ensure the servicing log history is up to date. Records on the new user must be updated to maintain traceability.

- **Inspection**

The equipment should have a rigorous inspection prior to the reissue, to include the points covered in the six monthly routine check, regardless of if the checks were recently completed. The equipment should be free of excessive wear or distortion in any aspect of its main construction or accessories.

- **Condition**

Wheels, tyres and brakes must be in good working condition, properly adjusted and

inflated as appropriate.

- **Accessories**

Check all accessories carefully for damage and potential shortcomings which may pose a risk to the user.

- **Function**

Ensure that all the functions of the chair are working correctly e.g. tilt in space, height adjustment, back recline, folding etc.

- **Fixings**

Check that any knobs, hand wheels, nuts, bolts, levers and fixings are in good condition and fitted in place securely.

- **Modifications**

Any special modifications, adaptations, alterations or other such procedures including added accessories may require review. If they are found inappropriate, remedial action (if considered safe and practical) should be taken to reverse them if possible.

- **Labelling**

Any labelling specific to the previous user should be removed and replaced with labelling specific to the new user.

- **Adjustment**

Adjustment of the equipment to the new user must be carried out by suitably qualified and experienced professionals. These adjustments along with the other appropriate checks and tests should be completed with the owners knowledge and agreement.

- **Hand Over**

Competent handing over of the equipment to the new user or attendant must include proper training and advice in safe use, particularly regarding transportation issues.

- **Packaging**

Always ensure that the chair is packaged correctly before delivery.

- **Handle Fitting**

Please note that the handle fitted is dependent on the size of the chair. You therefore need to ensure the size label on the handle matches the size of the chair being used.



design for living

.....

15 -18 Maxwell Road,  
Woodston Industrial Estate,  
Peterborough,  
Cambridgeshire  
PE2 7HU

Tel: 01733 405830  
Fax: 01733 405838  
Email: [enquiries@jcmseating.co.uk](mailto:enquiries@jcmseating.co.uk)



INVESTOR IN PEOPLE

